

MiTek®



STRUCTURAL PRODUCTS CATALOG

61ST EDITION

INTEGRATED BUILDING SOLUTIONS



SERVICES

Scale your business and outputs (take-offs, estimating, job quotes, and more) with the comfort of fixed overhead costs.



AUTOMATED SOLUTIONS

Optimize your entire prefabrication facilities workflow with off-site solutions that enable better on-site building.



SOFTWARE

Enhance your operational performance with software solutions that connect the entire supply chain.



ENGINEERED SYSTEMS & PRODUCTS

Accelerate your building process with a full range of advanced solutions that save on labor and installation costs.

SERVICES



Add or expand your capabilities without direct employment

Our team focuses on helping you grow your business with highly skilled resource options that scale as your requirements change.

DEDICATED DIRECT

Contract a full-time team member dedicated exclusively to your business.

- Extension of your existing team
- Dedicated technical staff skilled in all areas of building
- Dedicated exclusively to your business
- Trained as your employee
- Reduces labor costs associated with benefits, office, infrastructure, and HR expenses

DEDICATED MANAGED

Get the dedicated service benefits, plus a dedicated project manager.

- Liaison between your internal team and MiTek's services team
- Ensure seamless collaboration and communication
- Manages deadlines and budgets

PROJECT

Contract a team member to complete project-based work.

- As-needed support for fluctuating workloads
- Access to technical staff skilled in all areas of building
- Eliminates limited local talent challenges
- Reduces labor costs
- Reduces training, office, and infrastructure costs

Directory of Products

Code Evaluation Information	10
Corrosion Information	11-16
Design Notes	18-19
Installation Notes	19
New Products	3
Product Information	17
Product Notes	18
Reference Number Index	8-9
MiTek index	5-7

Angles & Straps 106-135

Angles	108-111, 113-115
Clips	112, 118-119
Header Hangers	118
Knee Braces	135
Lateral Joist Connectors	120
Ornamental Connectors	125
Straps	121-134
Stud Plate Ties	116-117

Caps & Bases 80-105

Column Bases	88-91
Column Caps	99-105
Post Anchors	82-85, 92
Post Bases	86-87, 98
Post Caps	93-97

Cold-Formed Steel 326-339

Angles	334
Concrete Screw Anchors	329
Fastening Information	328
Girder Tiedowns	338
Hangers	336-337
Holdowns	330-333
Hurricane Ties	339
Straps	335
Stud Plate Ties	338

Concrete & Masonry 40-63

Anchor Bolts	49-51
Anchor Rod Chairs	48
Anchoring Epoxy	42-43
Beam Seats	62
Bearing Plates	51
Concrete Form Ties & Wedge	54
Coupler Nuts	53
Foundation Anchors	55-61
Hangers	63
Hex Nuts	54
Mechanical Anchors	44-46
Retro Plates	61
Threaded Rods	47, 52
Washers	53

Deck & Fences 296-305

Angles	302
Deck Connectors	298-300
Fence Hardware	303-305
Stair Angles	301

EWP Hangers 202-231

Adjustable Connectors	230
EWP Hanger Selector Guide	204
EWP Installation	202-203
Face Mount Hangers	205-216
Top Mount Hangers	217-229
Slope/Skew Hangers	231

Fasteners 20-39

Bolts	38
Fastening Identification/Features	39
Nails	22-24
Screws	25-37

Fire Wall Hangers 194-201

Face Mount Hangers	200-201
Top Mount Hangers	194-199

General Hardware 306-317

Bridging	314-315
Corner Tie	316
D.I.Y. Products	309
Drywall Clip	308
Insulation Supports	308
Mending Plates	317
Nail Plates	317
Plywood Clips	308
Protection Plates	310
Shelf Brackets	316
Straps	311-312
Stud Shoes	312
Wall Bracing	313
Wall Ties	316

Glulam Beam Connectors 232-241

Face Mount Hangers	232-234
Hinge Connectors	240-241
Seismic Straps	241
Top Mount Hangers	234-239

Holdowns 64-79

Foundation Straps	73-77
Holdowns	66-69, 72
Purlin Anchors	78-79
Tension Ties	70-71

Lateral Systems 350-354

Lumber Hangers 136-193

Face Mount Hangers	139-165, 181-184
Hanger Selection Guide	138
Masonry Hangers	185-193
Panel & Purlin Hangers	177-181
Slope/Skew Hangers	173-176
Strap Hangers	172
Top Mount Hangers	166-171

Manufactured Housing 340-349

Foundation Anchor	347
Hangers	344
Installation Notes	342
Nails	343
Nail Plates	348
Plate Tie	347
Post Anchors	348
Protection Plates	349
Rafter Ties	345-346
Stud Plate Ties	346

Plated Truss 266-295

Alternate Installations	287
Blocking Supports	294
Drag Strut Connectors	282
Face Mount Hangers	268-272
Field Splice Kits	295
Girder Hangers	283-286
Hip/Jack Connectors	281-282
Hoist Plates	294
Skewed Nail Plate	280
Spacers/Braces	288-289
Strap Hangers	273-279
Supplementary Bearing Plates	290
Truss Clips	291-294

Specialty Options 318-325

Face Mount Hanger	321
Open Top Flange Hanger	322
Part Number System	325
Solid Top Flange Hanger	322-323
Specialty Options & General Notes	320
Top Flange Nailer Options	324
Welded Top Flange Hanger	325

Truss & Rafter 242-265

Angles	255-256
Girder Tiedowns	251-254, 257-259
Hurricane Ties	256, 262-264
Moisture Barrier Plates	244
Strap Connector	265
Truss Anchors	244-250
Truss Structural Wood Screw	260-261

MiTek Products Alphabetical Index

A

A Angle Clip 108-109
AB Anchor Bolts 51
AC Angle Clips 108-109
ADTT Adj. Deck Tension Tie 182, 298
Alternate Installations 287
ANJ Heavy Angles 115
ARC Anchor Rod Chairs 48
ATR All Thread Rod 52

B

B Bolts 38
B Corner Braces 114
BC Post Cap 93
BCS Post Caps 93
BD Bolt Down 305
BL Corner Braces 114
BN Breakfast Nook Hangers 282
BP Bearing Plates 51
BPH Beam & Purlin Hangers . . . 218, 221, 223-229

C

C Post Caps 93
CBE Column Bases 90
CBSQ Column Bases 91
CIA-GEL Epoxy 42
CLPBF Butterfly Hanger 268
CMST Coiled Strapping 126-127, 334
CMSTC Coiled Strapping 126-127, 334
CNW Coupler Nuts 53
CPB Composite Post Bases 98
CSH Concealed Stringer Hanger 181, 300

D

D Post Anchors 92, 348
DC Drywall Clip 308
DHTA Truss Anchors 248
DSC Drag Strut Connectors 282
DTB Deck Tie Back 66, 183, 299
DTC Truss Anchor 249
DTUS Undersaddle Hanger 180
DUC Ductile Undercut Anchors 44

E

EA Adhesive (CIA-EA) 43
EBG Elevated Post Base 87
EPB Elevated Post Bases 86-87
EPBH Elevated Post Bases 87
EPCM End Post Caps 94-95
ERB Fence Bracket 184, 304
EWP Hanger Selector Guide 204
EWP Installation 202-203

F

FA Foundation Anchors 55-56, 343
FB Fence Brackets 184, 304
FHD Panel Hanger 181
FRB Fence Brackets 184, 304
FS Truss Field Splice Kits 295
FSS Truss Field Splice Kits 295
FT Concrete Form Ties 54
FTC Floor Truss Clips 291
FTCF Floor Truss Clips 291
FWAN Foundation Wall Anchor 58
FWH Fire Wall Hangers 194-195
FWH/S CFS Fire Wall Hangers 336-337
FWHBP Fire Wall Hangers Beam Purlin . . . 196-197
FWHFM Face Mount Fire Wall Hangers . . . 200-201
FWHH Fire Wall Hangers 198-199

G

GEL Epoxy (CIA-GEL Series) 42
GHF Glulam Face Mount Hangers 233-234
GT Girder Truss Hangers 284-285
GTD Girder Truss Hangers 284-285
GTQ/GTQM Girder Truss Hangers 286
GTS Girder Truss Hangers 284-285
GTWS Girder Truss Hangers 283

H

Hanger Selector Guide 138
Hardy Frame® Moment Frames 353
Hardy Frame® Shear Wall 352
HBPH Top Mount Hangers 218, 223-229
HBPS Bearing Plates 51
HC Hurricane/Seismic Anchor 262-264
HCPRS Hurricane/Seismic Anchors 262-264
HD Face Mount Hangers 141-165, 186, 208, 213-216
HDO Top Mount Hangers 167, 169-171
HDO/S CFS Top Mount Hangers 335
HDOL/S CFS Top Mount Hangers 335
HDQIF Inverted Flange Hangers 141, 144-152, 156-164, 209, 214-216
HFS Straps 129, 311
HGA Hurricane Gusset Angles 256
HGAM Hurricane Gusset Angles 255
HGU Girder Hanger 232
HGUM Masonry Girder Hangers 187
HH Header Hangers 118
HHC Hip/Hip Connectors 281
HHCP Hurricane Ties 262-264
HHTA Truss Anchors 246-247
HJC Hip/Jack Connectors 281
HJHC Hip/Jack Connectors 281
HL Light Gauge Purlin Hangers 166, 169

HLBH Beam Hangers 219, 223-225, 227-229
HLPTA Truss Anchor 245
HN Hex Nuts 54
HPA Purlin Anchors 78-79
HPAHD Foundation Straps 76-77
HRS Strap Ties 121-123
HTA/HTAR Truss Anchors 246-247
HTC Heavy Truss Clip 294
HTHJ Hip/Jack Connectors 281
HTP Strap Ties 121-123
HTT Tension Ties 70, 331
HTW Twist Straps 130-131
HTWM Twist Straps 133
HUGT Girder Tiedowns 254, 258
HUS Slant Nail Hangers 140, 142-145, 149-150, 154-157, 161-162, 209, 214, 268
HWUH Top Flange Hangers 190-191

I

ICPL Protection Plates 310, 349
IHF Face Mount Hangers 206, 211-213
IHFL Face Mount Hangers 206, 211-213
IS Insulation Supports 308

J

JA Joist Angles 108-109
JDS Purlin Hangers 179
JH Multi-Purpose Joist Hangers 172
JL Face Mount Joist Hangers 139, 142-143, 154-155
JLIF Inverted Flange Hangers 139, 142-143, 154-155
JN/JNE Hangers 344
JNP Mending Plates 317
JPF Purlin Hangers 178
JUS Slant Nail Joist Hangers 140, 142-150, 154-162

K

KB Beam & Purlin Hangers 166, 170-171
KCB Column Base 88
KCBQ Column Bases 89
KCC Column Caps 103-105
KCCC Column Caps 105
KCCO Column Caps 105
KCCOB Column Caps 105
KCCCT Column Caps 105
KCCQC Column Caps 102
KCCQO Column Caps 102
KCCQOB Column Caps 102
KCCQ Column Caps 100-102
KCCQT Column Caps 102
KECC End Column Caps 103-105
KECCL End Column Caps 105

Continued on next page

MiTek Products Alphabetical Index

KECCQL End Column Caps	102	LL LumberLok Screws	36-37	PAE Post Anchors	82-83	
KECCQO End Column Caps	102	LPTA Embedded Truss Anchors	244	PAHD Foundation Strap	76-77	
KECCO End Column Caps	105	LS Light Slope Rafter Hangers	173	PAI Purlin Anchors	78-79	
KECCQ End Column Caps	100-102	LSSH Slope/Skew Hangers	174, 231	PAU Post Anchors	82-83	
KEG Glulam Beam Hangers	235	LSTA Strap Ties	121-123	PB Post Caps	96	
KEGQ Glulam Beam Hangers	234	LSTAD Foundation Straps	74-75	PBC Post Beam Corner	97	
KF Panel Hangers	177	LSTI Strap Ties	121-123	PBES Post Caps	96	
KGB Glulam Hangers	236	LTS Tension Ties	71, 331	PBS Post Caps	96	
KGH Floor Girder Hangers	63	LTTI Tension Tie	71	PC Plywood Clips	308	
KGLB Laminated Beam Seats	62	LTW Twist Straps	130-131	PCM Post Caps	94-95	
KGLBT Laminated Beam Seats	62	LUGT Girder Tiedowns	253, 257, 338	PCP Plastic Post Caps	305	
KGLS Glulam Saddle Hangers	238-239	M _____			PFM Concrete Screw Anchors	45, 329
KGLST Glulam Saddle Hangers	238-239	MB Bridging	315	PHD Predeflected Holdowns	66	
KGLT Glulam Beam Hangers	237-238	MBG Bridging	315	PHG Panel Hangers	177	
KHC Hinge Connectors	240-241	MGU Girder Hanger	232	PHM Top Flange Hangers	220-229	
KHCCT Hinge Connectors	240	ML Angles	113, 302	PHXU Top Flange Hangers	220-221, 223-225, 227-229	
KHCST/KHCSTR Seismic Straps	241	MP Framing Angles	108-111	PL Protection Plate	310, 349	
KHCT Hinge Connectors	240	MP/S CFS Framing Angles	333	Power-Stud® HD5 Anchors	46	
KHGB Glulam Hangers	236	MPA Framing Angles	110-111	Power-Stud® SD1 Anchors	46	
KHGLB Laminated Beam Seats	62	MPF Multi-Lateral Plate Ties	110-111, 347	PRT Pipe Rail Ties	303	
KHGLS Glulam Saddle Hangers	238-239	MPH Masonry Hangers	188-189	PS Strap Ties	124	
KHGLST Glulam Saddle Hangers	238-239	MRT Rafter Tie	346	R _____		
KHGLT Glulam Beam Hangers	237-238	MSH Strap Hangers	273-275	RBC Roof Boundary Clip	112	
KHHB Glulam Hangers	236	MSHL/R Skewed Truss Hanger	276	RC Plywood Clips	308	
KHL Heavy Angles	114	MSHA Adjustable Strap Skewed Hangers	278-279	RFUS Uplift Girder Tie	251	
KHSA Connector Straps	134	MSSHL/R Skewed Hanger	277	RP Retro Plate	61	
KHST Strap Ties	124	MSTA Strap Ties	121-123	RPB Retrofit Post Base	84	
KHW Top Flange Hangers	168, 170-171	MSTAM Masonry Straps	132	RR Ridge Rafter	173	
KLB Beam & Purlin Hangers	166, 169	MSTC Strap Ties	121-123	RS Coiled Strapping	126-127, 334	
KLCC Lally Column Caps	99	MSTCB Pre-Bent Strap	128	RSPT Stud Plate Ties	116	
KLEG Glulam Beam Hangers	235	MSTCM Masonry Straps	132	RST Rafter Tie	345	
KMEG Glulam Beam Hangers	235	MTHF Hanger	344	RT Hurricane Ties	262-264	
KNS Protection Plate	310, 349	MTW Twist Straps	130-131	RT/S CFS Hurricane Ties	339	
KRPS Strap Ties	124, 312	MUGT Girder Tiedown	254, 258	RTM Hurricane Retrofit Connector	256	
KSA Connector Straps	134	MUS Slant Nail Joist Hangers	140, 142-143, 154-155, 268	RUSC Strap Connector	265	
KSCT Corner Tie	316	N _____			RW Round Washers	53
KST Strap Ties	121-123	N Bridging	314	RWB Wall Bracing	313	
KSTI Strap Ties	121-123	N Nails	22-24	S _____		
KTS Twist Straps	130-131	NA Nails	22-24	S/PHD CFS Holdowns	330	
KVB Knee Braces	135	NFM Masonry Hangers	192-193	SB Shelf Bracket	316	
KVBI Knee Braces	135	NOP Moisture Barrier Plates	244	SBP Bearing Plates	290	
L _____			NP Mending Plates	SCA Stair Angles	115, 301	
L Straps	125	O _____			SDJT Joist Tie	119
LBP Bearing Plates	51	O Bridging	314	SDPT Strap Post Ties	119	
LBPS Bearing Plates	51	Ornamental series	125	SFC Framing Clip	118	
LDSC Drag Strut Connectors	282	P _____			SFJA Foundation Anchor	61
LFTA Strap	130-131, 262-264	PA Post Anchors	82-83	SFP Fence Post Connectors	305	
LGU Girder Hanger	232	PA Purlin Anchors	78-79	SHA Masonry Uplift Connectors	255	
LGUM Masonry Girder Hangers	187					
LH Straps	125					
LJC Lateral Joist Connector	120					
LJQ Lateral Joist Connectors	120					

Continued on next page

MiTek Products Alphabetical Index

SNP Skewed Nail Plate	280	TR Roof Truss Ties	293
Specialty Options	320-325	TS Truss Spacer	289
SPT Stud Plate Ties	116-117, 338	TSP Stud Plate Tie	116, 262-264
SPTH Stud Plate Ties	117	TSX Truss Spacers	289
SPTHW Stud Plate Ties	117, 346	TT D.I.Y. Products	309
SRCP Sill Retrofit Connector Plate	59	TTA Corner Bracket	309
SRC Sill Retro Connector	60	TTC Corner Tie	309
ST Foundation Anchors	57	TTF Bracket	309
ST Strap Ties	121-123	TTR Clip	309
Stabilizer	288	TTU Clip	309
STAD Foundation Straps	74-75	TUS Undersaddle Hanger	180
STB Anchor Bolts	49-50		
STBL Anchor Bolts	49-50	U _____	
STC Scissor Truss Clips	293	UGTS Uplift Girder Ties	252
STS Stud Shoes	312	UGTQ Girder Tiedown	259
SUH Joist Hangers . 139, 142-151, 153-163, 165		UMH Universal Masonry Hangers	185
SW Top Flange Hangers	168-170	UPHD Holdowns	67
SWH Top Flange Hangers	168-171	USC Uplift Girder Ties	252
T _____		V _____	
T Hoist Plates	294	VTT Valley Truss Tie	292
T Straps	125		
TA Foundation Straps	73	W _____	
TA Truss Anchors	250	WAS Wet Post Anchors	85
TAR Truss Anchors	250	WB Wall Bracing	313
TD Holdowns	68-69	WBC Wall Bracing	313
TDL Concrete Angles	113	WBT Wall Bracing	313
TDS CFS Holdowns	332	WE Wet Post Anchors	85
TDX Holdowns	68-69	WG Concrete Form Wedge	54
TFI Top Mount Hangers	217, 222, 224-225	WS Hex Head Screws	25, 32, 34
TFL Top Mount Hangers	217, 221-222	WSBH Bugle Head Screws	35
TH Straps	125	WSTS Truss Screws	260-261
THD Face Mount Truss Hangers	210, 215-216, 269	WSWH Washer Head Screws	26-31, 33-34
THDH Face Mount Hangers	210, 214-216, 270-271	WT Wall Ties	316
THDHDQ Girder Truss Hangers	272		
THF Face Mount Hangers	207, 213	Z _____	
THFI Face Mount Hangers	205, 212	Z4™ Tie-Down Systems	354
THO Top Mount Hangers	217, 221-226	ZC Blocking Supports	294
THR Threaded Rods	47		
TMP Rafter-To-Plate Connectors	230		
TMPH Rafter-To-Plate Connectors	230		
TPP Mending Plates	317		

WARRANTY

MiTek USA, Inc. ("MiTek") warrants its MiTek catalog Products to be free from material defects in manufacture and design, and further warrants that they will perform within the design limitations of its published building code approvals for the applications described, when properly installed and maintained. These warranties do not cover Product deterioration due to environmental conditions, Products that have been modified or damaged, improperly installed or used outside of published design limitations or for other applications. In the event any Product is shown to not conform to these warranties, MiTek's sole obligation, and Customer's sole and exclusive remedy, shall be, at MiTek's option, to replace the non-conforming product or refund the full purchase price paid by Customer to MiTek therefor. MITEK MAKES NO OTHER PRODUCT WARRANTIES,

EXPRESS OR IMPLIED, OF ANY KIND, AND PARTICULARLY EXCLUDES ANY IMPLIED WARRANTY OR MERCHANTABILITY OR FITNESS FOR A PARTICULAR PURPOSE. IN NO EVENT SHALL MITEK BE LIABLE FOR INCIDENTAL, CONSEQUENTIAL OR SPECIAL DAMAGES, REGARDLESS OF THE LEGAL THEORY OF RECOVERY, EVEN IF IT WAS AWARE OF THE POSSIBILITY OF SUCH DAMAGES. IN ANY CASE, MITEK'S MAXIMUM LIABILITY SHALL NOT EXCEED THE PURCHASE PRICE PAID BY CUSTOMER FOR THE NON-CONFORMING PRODUCT. Some states restrict consequential or other liability damage limitations, so some of the above limitations may not apply to you. MiTek reserves the right to change this warranty periodically. Consult MiTek's website MiTek-US.com or contact MiTek for a current warranty statement.

Reference Number Index

About the Reference Numbers

Reference numbers shown throughout the charts in this catalog are part numbers which may be more familiar to customers in various regions of the United States. These are included for the convenience of our new customers who have recently switched from a competitor's product line to MiTek.

The reference numbers in this catalog are for general application comparison only and should not be used as a substitution tool. The user is responsible to compare specific load values, fastener schedules, material specifications, and other factors to determine suitability of use for any particular product.

A Angle	109, 113-114
A34/A35 Anchor	111
ABA/ABU Post Base	83
ABL Anchor Bolt Locator	48
AC Post Cap	96
ATR All Thread Rod	52
BA Hanger	170, 221-226
BC Base	92, 348
BC Cap	93
BP Bearing Plate	51
BPS Bearing Plate	51
BT Brick Tie	185, 316
CB Column Base	88
CBSQ Column Base	91
CC Column Cap	103-104
CCQ Column Cap	100-101
CHC Component Hoist Clip	294
CMST Coiled Strap	126, 334
CMSTC Coiled Strap	126, 334
CNW Coupler Nut	53
CPS Composite Standoff	98
CS Coiled Strap	127, 334
DETAL Truss Anchor	248
DGHF Drywall Hanger	194
DJT Deck Tie	119
DPPC Decorative Post Cover	305
DPT Deck Tie	119
DS Drywall Stop	308
DSC Drag Strut Connector	282
DSP Double Stud Plate	116
DTC Roof Truss Clip	293
DTT Deck Tension Tie	66, 182-183, 298-299
ECC/ECCU Column Cap	104
ECCQ Column Cap	101
EG Hanger	235
EGQ Hanger	234
EPB Post Base	87
EPC Post Cap	95
F Hanger	177
FB Fence Bracket	184, 304
FBR Fence Bracket	184, 304
FGTR Girder Tiedown	251
FJA Anchor	61
FPBB44 E-Z Base™	305
FPBM44 E-Z Mender™	305

FPBS44 E-Z Spike™	305
FRFP Foundation Plate	59
FSC Strap	183, 299
FWANZ Foundation Wall Angle	58
GA Angle	109
GBC Gable Bracing	263
GH Hanger	63
GLB Beam Seat	62
GLS Hanger	239
H Hurricane Ties	131, 257, 263, 338
HB Hanger	223-229
HCA Hinge Connector	240-241
HCP Hip Corner Plate	263
HCSTR Strap	241
HD Holdown	69
HDB Holdown	69
HDQ Holdown	67
HDU Holdown	66-67
HETA Truss Anchor	246-247
HETAL Truss Anchor	249
HFN Hanger	177
HGA Gusset Angle	256
HGAM Gusset Angle	255
HGLB Beam Seat	62
HGLS Hanger	239
HGLT Hanger	224-225, 237
HGLTV Hanger	223-224, 227-229, 237
HGT Girder Tiedown	254, 258
HGU Girder Hanger	232
HGUM Girder Hanger	187
HGUS Hanger	215-216, 270-271
HH Hanger	118
HHDQ Holdown	67
HHETA Truss Anchor	247
HHUS Hanger	215-216, 269
HL Hanger	222, 224-225
HL Heavy Angle	114
HL Strap Tie	125
HM Hurricane Tie	256
HPA Purlin Anchor	79
HRS Strap Tie	123
HS Hurricane Tie	263
HST Strap	124
HSULC/HSURC Hanger	176
HSUR/HSUL Hanger	176
HT Strap Tie	125
HTC Heavy Truss Clip	294
HTPZ Strap Tie	122
HTS Twist Strap	131
HTSM Twist Strap	133
HTT Tension Tie	70
HTU Hanger	269
HU Hanger	142-165, 186, 213-216
HUC Hanger	143-153, 155-165
HUCTF Concealed Hanger	170
HUCQ Hanger	144-152, 156-164, 214-216
HUS Hanger	142-145, 149-150, 154-157, 161-162, 214, 268
HUSC Concealed Hanger	144-145, 149-150, 156-157, 161-162
HUSCTF Concealed Hanger	170

HUSTF Hanger	169-170
HUTF Hanger	169-171
HWP Hanger	223-225, 227-229
HWPB Hanger	224-225, 227-229
IS Insulation Supports	308
ITS Hanger	221-224
IUS Hanger	211-213
JB Hanger	169
JBA Hanger	169
L Angle	109
L Strap Tie	125
LB Hanger	169
LBP Bearing Plate	51
LCC Lally Column Cap	99
LCE Post Cap	96
LEG Hanger	235
LGT Girder Tiedown	253, 257
LGU Girder Hanger	232
LGUM Girder Hanger	187
LPCZ Post Cap	96
LS Angle	109
LSC Light Stair Stringer Connector	181, 300
LSSJ Hanger	174, 231
LSSR Hanger	174, 231
LSTA Strap Tie	122
LSTI Strap Tie	122
LSTHD Holdown	75
LTA Truss Anchor	244
LTB Bridging	314
LTHJA Hanger	281
LTP Framing Anchor	111, 347
LTS Twist Strap	131
LTT/LTTI Tension Tie	71
LU Hanger	142-143, 153-155, 165
LUC Hanger	142-143, 154-155
LUS Hanger	142-150, 154-162
MAB Mudsill Anchor	57
MASA Mudsill Anchor	56
MBHA Masonry Hanger	192-193
MBHU Masonry Beam Hanger	185
MEG Hanger	235
META Truss Anchor	247
MGT Girder Tiedown	254, 258
MGU Girder Hanger	232
MIT Hanger	221-226
MIU Hanger	211-213
ML Angles	113, 302
MMH Rafter Tie	346
MMLU Hanger	344
MMLUI Hanger	344
MP Mending Plate	317
MST Strap Tie	123
MSTA Strap Tie	122
MSTAM Strap Tie	132
MSTC Strap Tie	122-123
MSTCB Strap Tie	128
MSTCM Strap Tie	132
MSTI Strap Tie	123
MTS Twist Strap	131
MTSM Twist Strap	133
MUS Hanger	142-143, 154-155, 268

Continued on next page

Reference Number Index

Nails	23-24, 343	TC Truss Connector	293
NCA Nailless Bridging	315	THA Hanger	274-275
NS Nail Stopper	310, 349	THAC Hanger	274-275
NUT	54	THAI Hanger	274-275
OHA Hanger	125	THAL/R Hanger	276
OL/OT/OHL/OHT Hangers	125	THASR/L Truss Hanger	279
OS/OHS Hangers	125	THD Titen HD® Anchor	45, 329
PA Holdown	73	THGB/THGBH Hanger	284-285
PA Purlin Anchor	79	THGQ/THGQH Hanger	286
PAI Purlin Anchor	79	THJA Hanger	281
PB/PBS Post Base	85	THJM Hanger	282
PC Post Cap	94-95	THJU Hanger	281
PF Hanger	178-179	TJC Truss Connector	280
PFB/PFDB Hanger	179	TP Tie Plate	317, 348
PFDS Hanger	181	TS Twist Strap	131
PGT Pipe GripTie	303	TSBR Truss Spacer	288
PGTIC Pipe GripTie	303	TSF Truss Spacer	289
PS Strap	124	TSP Stud Plate Tie	116, 263
PSCA Sheathing Clip	308	TSS Truss Seat	244
PSCL Sheathing Clip	308	TWB Wall Bracing	313
PSPNZ Protective Plate	310, 349	U Hanger	142-151, 153-163, 165, 214
RBC Roof Boundary Clip	112	URFP Foundation Anchor	60
RCWB Wall Bracing	313	VB Knee Brace	135
RFB Retrofit Bolt	47	VPA Connector	230
RP Retro Plate	61	VTGR Valley Truss Clip	292
RPBZ Retrofit Post Base	84	W Wedge	54
RPS Strap Tie	124, 312	WA Wedge-All® Anchor	46
RR Connector	173	WASHER	53
RSP Stud Plate Tie	116	WB/WBC Wall Bracing	313
RST Rafter Tie	345	WMU Hanger	188-189
RTA/RTC/RTF/RTR/RTU Rigid Tie®	309	WP Hanger	169-171, 221-226
S/B Hanger	335	WT Wedge Form Tie	54
S/DTT Holdown	332	Z Clip	294
S/H Hurricane Tie	339		
S/HD Holdown	332		
S/HDU Holdown	330		
S/HTT Holdown	331		
S/LBV Hanger	335		
S/LS Angle	333		
S/LTT Holdown	331		
SA Strap Connector	134		
SBV Shelf Bracket	316		
SD Connector Screw	36		
SDS Heavy-Duty Connector Screw	25, 32		
SDW Multi-Ply Wood Screw	26, 33		
SDWC Screw	261		
SP Stud Plate Tie	116-117, 338		
SPECANGLE	114		
SPH Stud Plate Tie	116-117, 346		
SSP Single Stud Plate	116		
SSTB Anchor Bolt	50		
ST Strap Tie	122		
STC Roof Truss Clip	293		
STCT Roof Truss Clip	293		
STHD Holdown	75		
SUR/SUL Hanger	175-176		
T Strap Tie	125		
TA Staircase Angle	115, 301		
TB Tension Bridging	314		
TBE Truss Enhancer	290		
TBP Truss Seat	244		

Code Evaluation Information

Code Reference Column Chart Listing

Most structural products shown in this catalog are listed in a current code evaluation report from the code evaluation agencies listed.

The load values shown in this catalog were current at the time of printing but we are continually improving our products through better engineering design and development so some of the evaluation reports may have been updated with better load values after the catalog was printed.

In a few cases, we have submitted a formal independent test report from an approved lab to the code evaluation agency and are awaiting on an evaluation report.

We recommend visiting our web site: **MiTek-US.com** or, the specified code evaluation agency's web site, shown below, to obtain the latest load values from the most current evaluation report.

ICC-ES (ESR), icc-es.org

IAPMO Uniform-ES (ER), iapmoes.org

Florida (Florida Product Approval No.), floridabuilding.org

Some code jurisdictions may require additional load reductions and/or use limitations for some products listed in this catalog. In those cases, the products may not be approved or may need further review for approval.

We recommend contacting the code jurisdiction having authority for your project to confirm they accept the evaluation reports, or contact our Engineering Department for further assistance.

Code Reference Chart

Code Reference	Code Evaluation Agency	Building Code Coverage
IBC	ICC-ES IAPMO UES	International Building Code (IBC) International Residential Code (IRC)
FL	State of Florida Product Approvals	Florida Building Code (FBC)
LA	LA City - City of Los Angeles, California	Los Angeles Building Code (LABC) Los Angeles Residential Code (LARC) Products have a LABC & LARC Supplement to their ICC-ES or IAPMO UES evaluation report
PC	Prescriptive Code	Prescriptive construction requirements
--	None	No Code Listing

Code Evaluation Labeling Requirements:

Labeling products for field identification is part of our quality assurance program. Code evaluation agencies require that the label include the manufacturer's name or trademark, the model number, and code evaluation identification number. In addition, there must also be a number to trace the product back to the steel used in manufacturing.

The primary intent of this labeling is to allow confirmation that the connector being examined at on the jobsite is code approved. This can be verified by checking that code evaluation identification number on the code evaluation agencies website or MiTek-US.com.

Product Identification and Labeling



Labels are positioned on products so they can be seen after installation

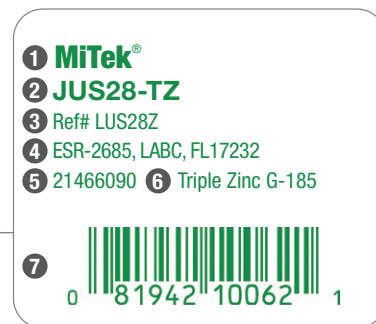

Typical Product Label

Each MiTek connector is identified with the following information:

- 1 **Product Brand:** MiTek®
- 2 **MiTek Stock Number:** Shows stock number as it appears in MiTek's literature and code evaluation reports.
- 3 **Reference Number:** Product number of a competitor that may be specified.
- 4 **Code Evaluation Identification Number:** The code evaluation identification number(s) are listed here. ESR-2685 is a general index report from ICC Evaluation Service, Inc. (ICC-ES) and provides a convenient cross-reference to many of our ESR reports.
- 5 **Work Order Number:** For structural product traceability.
- 6 **Corrosion Information:** Shows the corrosion resistant finish of the product.
- 7 **UPC Code**

Color Coding: Black print indicates standard G90 finish. Green print indicates corrosion resistant finish.

Corrosion Information

For the majority of applications, metal hangers and connectors are used in interior, above ground, dry service conditions. They are typically not being exposed to corrosive environments which can significantly reduce their strength and longevity.

What is Corrosion?

Corrosion is the destructive degradation of steel due to its interaction with the environment. Here the steel is the connector and the environment is whatever the connector interacts with, namely wood and air. Each environment may contain one or more corrodents (substances that cause corrosion) acting independently or in combination to degrade the strength of the connectors.

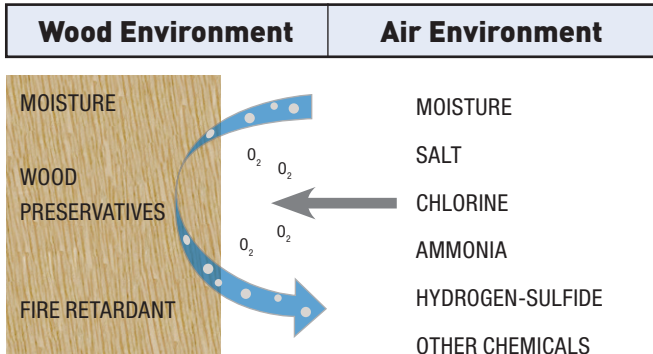

Electrochemical oxidation is the most common type of corrosion affecting metal connectors. It is a process in which iron (Fe) reacts with oxygen (O₂) in the presence of an electrolyte such as water (H₂O) to form iron oxide (Fe₂O₃), a brown and flaky by-product commonly known as rust.

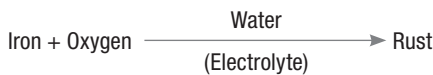

Steel is an iron-based metal alloy which is susceptible to this type of corrosion, even when exposed to normal atmospheric air, since air contains oxygen and water as part of its normal composition. While steel is very strong, rust is not. Over time, the continuous formation of rust eats away the base metal and reduces the strength of the connector. The rate of oxidation generally increases with increasing moisture content, the presence of salt, or when galvanic corrosion is a contributing factor.

Galvanic Series (Abbreviated)	
More Active (Anodic-)	
↑	Zinc
	Aluminum
	Steel
	Brass
	Copper Nickel
	Stainless Steel - Type 304
	Stainless Steel - Type 316
More Passive (Cathodic +)	

Galvanic corrosion occurs when there is an interaction between dissimilar metals that are in contact with one another. The degree of corrosion depends on where the metals reside in the galvanic series, which is a compilation of known metals and their relative reactivity. The more active metal (anode) will corrode preferentially while shielding the more

passive metal (cathode) from further degradation. For example, with galvanized steel, zinc is used as a coating on the steel because it sacrificially corrodes to protect the steel substrate underneath. The coupling between zinc and steel is said to have a lower galvanic potential than the coupling between zinc and stainless steel because zinc and steel are closer to each other in the galvanic series. In general, the coupling with a lower galvanic potential would result in a slower corrosion rate.

Corrosion Protection Options

Zinc Galvanizing:

Most connectors are manufactured from pre-galvanized sheet steel or coiled steel, which is typically made by the hot-dip process in accordance with ASTM-A653 and ASTM-A924 standards. Fasteners are galvanized in accordance with ASTM-A153. In the manufacturing of the connectors, the punching and shearing processes create exposed bare metal surfaces. Thankfully, zinc has an incredible ability to 'heal' itself; the zinc around the exposed metal corrodes and deposits a layer of zinc corrosion by-product called zinc patina (white powdery appearance) over the exposed metal to further protect it.

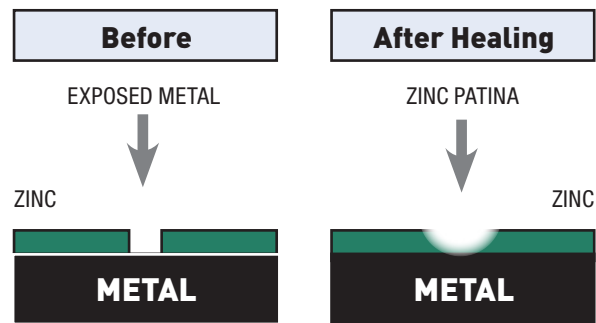

By being more reactive than steel, zinc sacrificially corrodes at a steady rate over time to shield the steel from the effect of corrosion. The protection ability of zinc is proportional to its thickness, which is proportional to the amount of zinc applied. Zinc coating is specified as the total weight on both sides of the sheet steel, measured in ounces per square foot (oz/ft²). For example, G90 means that there are 0.90 oz/ft²; G185 has 1.85 oz/ft² and would last about two times longer than G90. G90 is the minimum protection for connectors and is standard in MiTek connectors.

Design Guidelines:

Where there are governing national or local building code requirements, they should be used in the selection of the connectors and their protection against corrosion. In the absence of such requirements, the decision rests on the experience and judgment of the building designer/engineer. Design guidelines are presented in this section to aid the building designer/engineer in this selection process, but it is the responsibility of the building designer/engineer to determine the most viable solution based on an evaluation of the connectors to the specific corrosive environment(s). The guidelines consist of best practices, recommended protection levels for the connectors, and strength modification factors for the lumber/connectors.

Where there are multiple options suggested, do not automatically default to the lowest protection level. The lower protection level is intended to address less severe conditions while the higher protection level is meant to address more severe conditions. Select the option that eliminates or adequately reduces the vulnerability of the connectors to the corrodents. When in doubt, use a higher level of protection than anticipated or seek professional consultation.

Continued on next page

Corrosion Information

Relative Corrosion Resistance Capability:

The chart below ranks the available options in terms of their relative effectiveness against corrosion. As expected, the ability to resist corrosion increases with increasing zinc thickness, so G185 is the most durable pre-galvanized product available. Gold Coat offers enhanced protection compared to G185 while stainless steel offers the best protection for most applications.

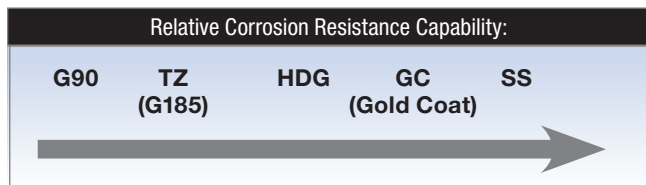

Galvanic Corrosion:

The simplest and most practical solution to minimize galvanic corrosion is to make sure that the components that are in direct contact with each other are made of the same material or coating. Once this is achieved, there is no net galvanic potential between the components and galvanic corrosion is eliminated or significantly reduced. For example, use galvanized nails for galvanized connectors and stainless steel nails for stainless steel connectors.

Wet Service Condition:

For lumber, this refers to any service condition in which the average equilibrium moisture content is 15% or more over a year or may exceed 19% at any time. For lumber to get above 19% moisture, the relative humidity in the air needs to reach above 80%. Unfortunately, this is above the critical humidity level for the electrochemical oxidation of steel, which is around 70%. Beyond 70%, the rate of corrosion in the connectors increases rapidly due to the abundant availability of moisture.

G90 may not be suitable for use in wet service condition.

Preservative (Pressure) Treated Wood:

There are many preservative wood treatment formulations available on the market today. The element that is common to most of them is the presence of copper in the formulation which can contribute to the corrosion of steel connectors and fasteners.

Of the copper based preservatives, the two types are micronized copper and soluble copper. Micronized copper formulations MCA (micronized copper azole) and MCQ (micronized copper quat) are sold under different brand names and are the most predominant formulation in today's preservative treated wood industry. Soluble copper formulations CA (copper azole) and ACQ (alkaline copper quat) have also been very popular since they replaced CCA (chromated copper arsenate) which was phased out in 2004. Some "metal free" preservatives are still used for above ground and sill plate applications, but are not as common. One of the main criterion affecting the selection of one preservative treatment over another is the type of wood being treated and how well it can be penetrated by the treatment.

While many of the advanced wood treatment formulations containing copper used today have proven to be less corrosive to steel, especially micronized copper, MiTek recommends a higher level of corrosion protection for connectors in contact with copper based wood treatments.

Connectors and fasteners in contact with metal free wood preservatives do not require additional corrosion protection due to the preservative itself, however all factors that can create the corrosive environment should be considered when selecting the appropriate finish. If unsure as to whether a particular treatment is corrosive to steel fasteners, check with the supplier of the preservative treated wood product for their recommendation.

Fire Retardant Treated (FRT) Wood:

Although most common FRT products are not corrosive to metal connectors, not all products are non-corrosive. Additionally, they typically require proprietary strength reductions applied to the lumber in accordance with the manufacturer's specifications. Since the lumber strength is lower, the lateral and withdrawal resistance of nails must also be reduced accordingly. It is important to note that some fire retardants cause the wood to absorb more moisture from the air than untreated lumber. Consequently, the connector may be exposed to a higher level of moisture, resulting in more corrosion.

Swimming Pools:

This is one of the most hazardous environments for steel connectors due to continuous exposure to high temperature, high moisture content, and corrosive chemicals such as chlorine, bromine, and other disinfectants. The combination of all these factors can lead to accelerated corrosion and premature structural failure. This environment is so corrosive that all possible preventive measures should be employed to prevent the hanger from being exposed to the pool water. These include the use of a vapor barrier and a ventilation system that does not take the air from the pool environment.

Additionally, it has been known that certain grades of stainless steel (316 and others) are susceptible to a mode of structural failure known as stress corrosion cracking (SCC) when exposed to a swimming pool environment. SCC is usually localized near areas of high residual stress and small cracks can rapidly propagate and cause catastrophic failures. See warning below.

WARNING

Stainless steel connectors and fasteners shall not be used for metal hangers over swimming pools due to stress corrosion cracking. SCC has been known to occur under the following conditions:

- Use of certain grades of stainless steel (grades 316 and others).
- Structural members subjected to high tensile stress.
- Presence of certain chemicals, including chlorine and bromine.

Gold Coat may be the best choice in this environment.

Corrosion Information

The **Structural Connectors Coating Recommendations** chart below was developed by reviewing field service performance and accelerated corrosion test results. They are offered as general guidelines and are not intended to cover all possible service conditions. Additional consideration may also be needed for:

- wet service conditions
- preservative treated lumber
- fire retardant treated lumber
- strength reducing chemicals
- building near salt water coastal areas

Additionally, the **Corrosion Protection Guidelines** to the right may also be used to assist in making the proper choice of corrosion protection.

The building designer/engineer has the ultimate responsibility of selecting the most viable protective coating based on knowledge of project specific corrosive environments and local building code requirements.

Corrosion Protection Guidelines:

- MiTek recommends stainless steel connectors for the highest level of corrosion protection. As an economical alternative to stainless steel our new Gold Coat connectors are specifically designed for exterior application when in contact with preservative treated wood.
- For connectors in contact with preservative treated wood, the Triple Zinc option provides the minimum G-185 coating thickness required by code and is an economical alternative for exterior applications.
- The use of correct fastener with the connector is critical. Stainless steel connectors require stainless steel fasteners. For exterior applications, hot-dip galvanized fasteners (HDG) or exterior coat (EXT) must be used with both Triple Zinc and hot-dip galvanized finishes. Gold Coat connectors require gold coat or hot-dip galvanized fasteners.
- MiTek's zinc dichromate WS Structural Wood Screws are not recommended for use with preservative or fire-retardant treated wood. Some wood structural screws are available in Gold Coat or exterior coat.
- MiTek clearly differentiates standard interior G90 connectors from the corrosion resistant connectors. Gold Coat connectors are distinguishable from other connectors due to their gold color.

Structural Connectors Coating Recommendations

AWPA ⁹ Use Category	Service Conditions	Use Environment	Example Applications	Preservatives and Retentions ^{6,7,10}	Minimum Coating Requirements ^{1,2,3,4}
UC1 Interior/Dry	Interior construction, Above ground, Dry	Continuously protected from weather or other sources of moisture	General framing, interior construction	Untreated	G90
UC2 Interior/Damp	Interior construction, Above ground, Damp	Protected from weather, but may be subject to sources of moisture	Sill plates	SBX-DOT, Organic ACQ-D (0.15), CA-B (0.10), CA-C (0.06), MCQ (0.06), μCA-C (0.05)	G90 Triple Zinc (G-185) ^{8,9} , HDG (post hot dipped), Exterior Coat ¹²
UC3A Above Ground Protected	Exterior construction, Above ground, Rapid water runoff	Exposed to all weather cycles, not exposed to prolonged wetting	Exposed exterior beams or columns in an open, covered structure	ACQ-D (0.25), MCQ (0.15), CA-B (0.10), CA-C (0.06), μCA-C (0.05), Organic	Triple Zinc (G-185), HDG (post hot dipped), Exterior Coat ¹² or MiTek Gold Coat
UC3B Above Ground Exposed	Exterior construction, Above ground, Poor water runoff	Exposed to all weather cycles, including prolonged wetting	Deck beams and joists	ACQ-D (0.25), MCQ (0.15), CA-B (0.10), CA-C (0.06), μCA-C (0.05), Organic	Triple Zinc (G-185), HDG (post hot dipped), or MiTek Gold Coat
UC4A Ground Contact General Use	Ground contact, Fresh water; includes above ground applications	Ground contact or fresh water exposed to all weather cycles, Normal exposure	Deck posts, beams and joists. Fresh water docks ¹¹	ACQ-D (0.40), MCQ (0.23), CA-B (0.21), CA-C (0.15), μCA-C (0.14)	Triple Zinc (G-185), HDG (post hot dipped), or MiTek Gold Coat ⁵
UC4B Ground Contact Heavy Duty	Exterior construction, Ground contact, Critical components	Ground contact, fresh/salt water water splash exposed to all weather cycles	Permanent wood foundations, critical structural members	ACQ-D (0.60), MCQ (0.23), CA-B (0.31), CA-C (0.25), μCA-C (0.23)	Stainless Steel











- 1) G90 and G-185 refer to galvanization requirements for ASTM A653 material.
- 2) Connectors galvanized to ASTM A123 may be used in place of either G90 or G185 coatings.
- 3) Other coating may be suitable for a given environment if the conditions are known and predictable.
- 4) For G185 connectors use fasteners galvanized per ASTM A153. For Gold Coat connectors, use Gold Coat fasteners and for stainless steel connectors, use stainless steel fasteners.
- 5) If the environment has the potential to contain elements which may make it more corrosive, the use of stainless steel is recommended.
- 6) MCQ is a micronized copper treatment such as *Micro Pro* by Koppers. μCA-C is a dispersed copper treatment manufactured by Arch Treatment Technologies. Organic preservatives include L³ from Arch Treatment Technologies and EcoLife II from Viance, LLC.
- 7) For wood treatments not shown, contact MiTek or the wood preservative manufacturer for recommended coatings.
- 8) Testing by MiTek has found that in interior applications where the treated wood will remain relatively dry during its service life the use of G90 connectors with MCQ or μCA-C treated wood is appropriate.
- 9) American Wood Protection Association Standard U1-16.
- 10) SBX/DOT= Sodium Borate; ACQ-D = Alkaline Copper Quat Type D; CA-B = Copper Azole Type B; CA-C = Copper Azole Type C; MCQ = Micronized Copper Quat; μCA-C = Dispersed Copper Azole Type C. The number listed in the parenthesis is the required retention level in pounds per cubic foot, or PCF.
- 11) Deck joists and beams must be treated to Use Category UCA4 when they are difficult to maintain, repair or replace and are critical to the performance and safety of the deck.
- 12) Users must perform periodic inspection and provide regular maintenance to ensure the satisfactory performance of the structure.

Continued on next page

Corrosion Information

Corrosion Resistant Finishes

MiTek offers several corrosion resistant finishes to cover a range of corrosion performance. For products available in corrosion resistant finishes, reference the “Corrosion Finish” column in the charts and Corrosion Key located by the chart footnotes or pages 15-16 for a complete listing of corrosion resistant products.

Corrosion Protection Level	Finish / Material	Description	Required Fastener	Ordering
CONNECTORS				
	Primer	Primer paint is used to protect steel during shipping and installation but is not considered a corrosion protection method when installed in corrosive environments	Bright fasteners	Stock number as listed in the chart
	G90 Galvanizing	Galvanizing provides a prefabrication coating of 0.90 ounces of zinc per square foot of surface area (both sides) measured in accordance with ASTM A 653	Bright fasteners	Stock number as listed in the chart
	Triple Zinc (TZ) (G-185 Galvanizing)	TZ galvanizing provides a prefabrication coating of 1.85 (G-185) ounces of zinc per square foot of surface area (both sides) measured in accordance with ASTM A 653	Hot-dip galvanized or Exterior Coat fasteners	To order, add TZ to stock number, as in C44-TZ
	Hot-Dip Galvanized (HDG)	HDG coating provides an after-fabrication hot-dipped zinc coating. The coating thickness is dependent on the connector material, but generally ranges from 1.2 to 2.3 ounces of zinc per square foot of surface area (both sides). Hot-dip products meet requirements set forth in ASTM A 123	Hot-dip galvanized or Exterior Coat fasteners	To order, add HDG to stock number, as in KCC44-HDG
	Gold Coat (GC)	Gold Coat is a proprietary multi-layer protection system. It is comprised of a top coat barrier layer and a galvanized layer placed over a steel substrate	Gold Coat or Hot-dip galvanized fasteners	To order, add GC to stock number, as in AC7-GC
	Stainless Steel (SS)	Best option for corrosion protection. Quality stainless steel (316SS grade steel) is used to fabricate connectors. Although costs are higher, some applications may need the virtual corrosion proof quality of stainless steel	Stainless Steel fasteners	To order, add SS to stock number, as in PBES44-SS
FASTENERS				
	Yellow Zinc	Zinc yellow chromate finish		Stock number as listed in the chart
	Hot-Dip Galvanized (HDG)	HDG coating provides an after-fabrication hot-dipped zinc coating. The coating thickness is dependent on the connector material, but generally ranges from 1.2 to 2.3 ounces of zinc per square foot of surface area (both sides). Hot-dip products meet requirements set forth in ASTM A 153		Stock number as listed in the chart
	Exterior Coat (EXT)	EXT finish is a double barrier coating over zinc		Stock number as listed in the chart
	Gold Coat (GC)	Gold Coat is a proprietary multi-layer protection system. It is comprised of a top coat barrier layer and a galvanized layer placed over a steel substrate		Stock number as listed in the chart
	Stainless Steel (SS)	Best option for corrosion protection		Stock number as listed in the chart

DISCLAIMER – The general information and guidelines provided in this MiTek Product Catalog shall not be used as a substitute for competent professional examination and verification. It is the responsibility of the building designer/engineer to determine the applicability and suitability of the information provided. Anyone making use of this information assumes all responsibility and liability arising from such use.

Corrosion Information

Corrosion Resistant Product Offering

MiTek Stock No.	Triple Zinc G-185 (TZ)	Hot-Dip Galv. (HDG)	Exterior Coat (EXT)	Gold Coat (GC)	Stainless Steel (SS)	MiTek Stock No.	Triple Zinc G-185 (TZ)	Hot-Dip Galv. (HDG)	Gold Coat (GC)	Stainless Steel (SS)	MiTek Stock No.	Triple Zinc G-185 (TZ)	Hot-Dip Galv. (HDG)	Gold Coat (GC)	Stainless Steel (SS)
Fasteners / Anchors					Holdowns / Foundation Anchors					Column / Post Caps					
AB1212-HDG						FA3					KECC525-4				
AB126-HDG						FA4					KECC525-6				
AB128-HDG						FWAN-TZ					KECC64				
AB5812-HDG						LTS19-TZ					KECC66				
BP12						RP6					KECC68				
BP583						ST1-TZ					KECC88				
HBPS12						ST2-TZ					KECCQ325-4				
HBPS12-412						STB16					KECCQ325-6				
HBPS58						STB20					KECCQ44				
HBPS58-412						STB24					KECCQ46				
HBPS34-412						STB28					KECCQ48				
LBP12-TZ						STB34					KECCQ525-4				
LBP58-TZ						STB36					KECCQ525-6				
LBPS12-TZ						STBL24					KECCQ525-8				
LBPS58-TZ						TA51					KECCQ64				
LL915						TDL5					KECCQ66				
LL930						TDX2-TZ					KECCQ71-4				
N10C						Column / Post Caps					KECCQ71-6				
N10-GC						BC400-TZ					KECCQ74				
N16C						BCS22-4					KECCQ76				
N8-GC						BCS23-6					PB44-6TZ				
NA11						C44					PB66-6TZ				
NA16D						C46					PBC44-TZ				
NA20D						C46R					PBC66-TZ				
NA9D						C66					PBES44				
SSN10C						C66R					PBES66				
SSN16C						EPCM4416					PBS44				
SSN8C						EPCM4616					PBS66				
SSNA10D						EPCM6616					PBS66R				
SSNA8D						EPCM66					PCM44				
THR1218-HDG						KCC325-4					PCM4416				
THR1224-HDG						KCC325-6					PCM46				
THR1236-HDG						KCC44					PCM4616				
THR125-HDG						KCC46					PCM4816				
THR126-HDG						KCC48					PCM66				
THR128-HDG						KCC525-4					PCM6616				
THR5812-HDG						KCC525-6					Column / Post Bases				
THR5816-HDG						KCC64					CBSQ44-TZ				
THR588-HDG						KCC66					CBSQ46-TZ				
WS15						KCC68					CBSQ66-TZ				
WS2						KCC88					D44-TZ				
WS25						KCCQ325-4					D46				
WS3						KCCQ325-6					D46R-TZ				
WS35						KCCQ44					D66				
WS45						KCCQ46					D66R				
WS5						KCCQ48					EBG44-TZ				
WS6						KCCQ525-4					EBP44T-TZ				
WS8						KCCQ525-6					EPB4408				
WSBH25-EXT						KCCQ525-8					EPB4608				
WSBH4-EXT						KCCQ64					EPB6608				
WSBH6-EXT						KCCQ66					EPBH44				
WSBH8-EXT						KCCQ71-4					EPBH46R				
WSBH10-EXT						KCCQ71-6					EPBH66				
WSWH278						KCCQ74					EPBH66R				
WSWH358-EXT						KCCQ76					KCB44				
WSWH45						KECC325-4					KCB46				
WSWH5						KECC325-6					KCB48				
WSWH6						KECC44					KCB66				
WSWH8-EXT						KECC46					KCB68				

Corrosion Finish Key ■ Stainless Steel ■ Gold Coat ■ Exterior Coat ■ HDG ■ Triple Zinc

Continued on next page

Corrosion Information

Corrosion Resistant Product Offering

MITek Stock No.	Triple Zinc G-185 (TZ)	Hot-Dip Galv. (HDG)	Gold Coat (GC)	Stainless Steel (SS)	MITek Stock No.	Triple Zinc G-185 (TZ)	Hot-Dip Galv. (HDG)	Gold Coat (GC)	Stainless Steel (SS)	MITek Stock No.	Triple Zinc G-185 (TZ)	Hot-Dip Galv. (HDG)	Gold Coat (GC)	Stainless Steel (SS)	MITek Stock No.	Triple Zinc G-185 (TZ)	Hot-Dip Galv. (HDG)	Gold Coat (GC)	Stainless Steel (SS)
Column / Post Bases					Lateral Joist Connectors					Hangers					Hurricane Ties				
KCB88					LJC-TZ					HUS210-2IF					HHCP2				
KCB1010					LJQ35-TZ					HUS212-2					HHCP4-TZ				
KCB1212					Twist Straps					HUS26				LFTA6					
KCBQ44					HTW20					HUS28					RT10				
KCBQ46					LTW12					HUS28-2IF					RT15				
KCBQ66					LTW18					JL210IF-TZ					RT16-2				
KCBQ88					MTW12					JL241F-TZ					RT16A				
PA44E					MTW16					JL261F-TZ					RT20				
PA44					MTW20					JL281F-TZ					RT3A				
PA46E					MTW30					JPF24					RT4				
PA46					Straps					JUS210				RT5					
PA55R-TZ					HRS416-TZ					JUS210-2					RT7				
PA66E					HTP37-TZ					JUS210-3					RT7A				
PA66ER-TZ					KHST2					JUS24					RT8A				
PA66R					KHST3					JUS24-2					Embedded Truss Anchors				
PA66					KRPS22					JUS26					HTA20				
PAU44					KRPS28					JUS26-2					Deck & Fences				
PAU46					KST227					JUS28					ADTT-TZ				
PAU66					KST237					JUS28-2					CSH-TZ				
PAU66R-TZ					KST248					JUS28-3					DTB-TZ				
PAU88					KST260					JUS36					ERB24-TZ				
PAU1010					L6					JUS410					FB14-TZ				
PAU1010R					LH12					JUS44					FB23-TZ				
PAU1212					LSTA36					JUS46					FB24-TZ				
PAU1212R					MSTA12					JUS48					FB26-TZ				
RPB-TZ					MSTA15					KLB210					FRB24-TZ				
WAS44					MSTA18					KLB212					PRT15-TZ				
WAS46					MSTA21					LSSH15-TZ					PRT2H-TZ				
WAS66					MSTA24					LSSH210-TZ					PRT2-TZ				
WE44					MSTA30					LSSH179-TZ					PRTC2-TZ				
WE46					MSTA36					LSSH20-TZ					SCA10-TZ				
WE66					MSTA9					LSSH23-TZ					SCA9-TZ				
Framing Plates & Angles					MSTAM24					LSSH25-TZ				SDJT14-TZ					
A3					MSTAM36					LSSH26-TZ					SDPT5-TZ				
AC5					PS218-HDG					LSSH31-TZ					SDPT7-TZ				
AC7					PS418-HDG					LSSH35-TZ					General Hardware				
AC9					PS720-HDG					MSH422					ICPL516-TZ				
ANJ44S-HDG					RS150					SKH210L					ICPL58				
JA1					RS16-R					SKH210L-2					TTA12-TZ				
KHL33					T6					SKH210R					TTA2-TZ				
KHL35					TH12-HDG					SKH210R-2					TTC42-TZ				
KHL37					Hangers					SKH26L				TTF22-TZ					
KHL43					HD210-2IF					SKH26R					TTR-TZ				
KHL46					HD210-3IF					SKH28L					TTU2-TZ				
KHL55					HD28-2IF					SKH28R					WT22				
KHL57					HD410					SKHH210L-2									
KHL76					HD410IF					SKHH210L-2IF									
ML24-TZ					HD412					SKHH210R-2									
ML26-TZ					HD412IF					SKHH210R-2IF									
MP3					HD441F					SKHH410L									
MP34					HD46					SKHH410LIF									
MP4F					HD461F					SKHH410R									
MP5					HD48					SKHH410RIF									
MP6F					HD481F					SKHH414LIF									
MP7					HD610					SKHH414RIF									
MP9					HD610IF					SKHH46L									
MPA1					HD612					SKHH46LIF									
Stud Plate Ties					HD612IF					SKHH46R									
RSPT6					HD68					SKHH46RIF									
RSPT6-2					HD681F					SUH210									
SPT22					HDQ210-2IF					SUH210-2									
SPT24					HDQ210-3IF					SUH210-3									
SPT4					HDQ310IF					THD28-2									
SPT6					HDQ410IF					THD410									
SPT8					HDQ412IF					THD46									
SPTH4					HDQ610IF					THD48									
SPTH6					HDQ612IF					THDH412									
SPTH8					HUS210					THDH610									

Corrosion Finish Key ■ Stainless Steel ■ Gold Coat ■ Exterior Coat ■ HDG ■ Triple Zinc

Product Information

U.S. Standard Steel Gauge Equivalents in Nominal Dimensions

Gauge	Approximate Dimensions		Decimals (inches)		
	Inches	Millimeters	Uncoated Steel	Galvanized Steel (G90)	Triple Zinc (G-185)
3	1/4	6.0	0.238	--	--
7	3/16	4.5	0.171	0.186	--
10	9/64	3.4	0.129	0.138	0.140
11	1/8	3.0	0.114	0.123	0.125
12	7/64	2.7	0.099	0.108	0.110
14	5/64	2.0	0.070	0.078	0.080
16	1/16	1.5	0.055	0.063	0.065
18	3/64	1.2	0.044	0.052	0.054
20	1/32	1.0	0.033	0.040	0.042
22	1/32	0.8	0.029	0.033	0.036

*Actual steel dimensions will vary from nominal dimensions according to industry tolerances.

Maximum Shear Capacity of Joist or Rafter

The table below indicates the calculated shear capacity of different dimensional lumber sizes for various wood species.

Wood Species	Allowable Shear on Bending Member ^{1,2,3}											
	Joist or Rafter											
	2 x 4			2 x 6			2 x 8			2 x 10		
	100%	115%	125%	100%	115%	125%	100%	115%	125%	100%	115%	125%
DF	630	725	788	990	1139	1238	1305	1501	1631	1665	1915	2081
SP	613	704	766	963	1107	1203	1269	1459	1586	1619	1862	2023
S-P-F	473	544	590	743	854	928	979	1126	1223	1249	1436	1561
Hem Fir	525	604	656	825	949	1031	1088	1251	1359	1388	1596	1734

- 1) Applies to nominally dimensioned joists as listed, where moisture content < 19% and temperature < 100° F.
- 2) Loads apply to: DF: Douglas Fir-Larch (G=0.50), Fv=180 psi; SP: Southern Pine (G=0.55), Fv=175psi; S-P-F: Spruce-Pine-Fir (G=0.42), Fv=135psi; Hem Fir (G=0.43), Fv=150psi.
- 3) 115% and 125% loads are increased for short-term loading in accordance to the code.

Roof Pitch

If common Rafter Roof Pitch is ...

Rise / Run (inches)	Slope (degrees)
1/12	5
2/12	10
3/12	14
4/12	18
5/12	23
6/12	27
7/12	30
8/12	34
9/12	37
10/12	40
11/12	42
12/12	45

Then Hip/Valley Rafter Roof Pitch becomes ...

Rise / Run (inches)	Slope (degrees)
1/17	3
2/17	7
3/17	10
4/17	13
5/17	16
6/17	19
7/17	22
8/17	25
9/17	28
10/17	30
11/17	33
12/17	35

Slope Conversion Table

Rise / Run (inches)	Slope (degrees)
0/12	Flat
1/12	5
2/12	10
3/12	14
4/12	18
5/12	23
6/12	27
7/12	30
8/12	34
9/12	37
10/12	40
11/12	42
12/12	45

- 1) Use this conversion table only for hip/valley rafters that are skewed 45° right or left. All other skews or dual pitch roofs will cause the slope to change from that listed above.

Special & Custom Connectors

MiTek is committed to meeting every need you have and we understand that stock connectors will not meet all application or design requirements. Our Technical Assistance Representatives will work with you to develop and fabricate the Special or Custom connector you need.

What is the difference between a "Special" and a "Custom" connector?

A "Special" is a stock MiTek connector that is modified within the limits listed in the Specialty Options chart for that connector. A summary of Specialty Options can be found on page 320 of this catalog.

A "Custom" is a connector that does not closely resemble a stock or special part offered in our catalog. Also, a "Custom" connector may be a stock connector that is modified outside of the limits listed in the Specialty Options charts or is not listed in the catalog as having a specialty option available. Product drawings must be provided by the customer and will be manufactured by MiTek in accordance to customer specifications. Customs should be verified prior to ordering and are not refundable.

See page 320-323 for additional information.

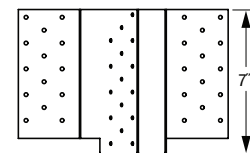
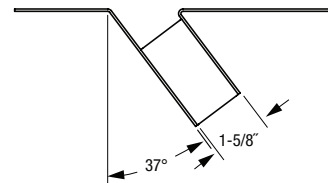

Special Order EXAMPLE: Skewed HD < 45°

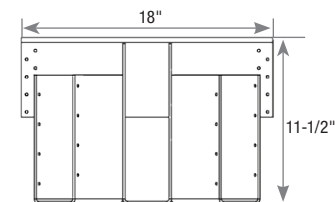
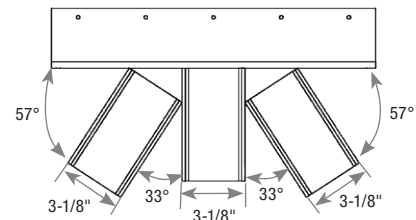

Custom Order EXAMPLE: HLBH 3 Pocket Girder Truss Hanger

General Information

Product Notes

- 1) This catalog reflects the most current information available at the time of printing. However, we are continually improving our products through better engineering design and development and recommend visiting our website for the latest on-line version of the catalog at MiTek-US.com. MiTek reserves the right to change specifications, designs, and models at any time without notice and liability for such changes. This catalog may not be reproduced in whole or in part without the prior written approval of MiTek.
- 2) This catalog reflects changes to product design and allowable loads to some MiTek products. The information presented in this publication supersedes all previously published Product Catalogs.
- 3) This Product Catalog was designed as a general reference for the MiTek Product Line. Various specialized publications have also been developed for design professionals, truss manufacturers, contractors, and building material distributors. Consequently, product information may vary from one publication to another due to product development testing and revisions to code evaluation report upgrades. We recommend visiting our website for the latest on-line version of these specialized publications.
- 4) The type and quantity of fasteners used to install MiTek products is critical to connector performance. To achieve the allowable loads presented in this catalog, all specified fasteners must be used and proper installation procedures observed (refer to footnotes under Allowable Loads tables in the product's ICC-ES ESR code evaluation report for possible substitution of TECO brand pneumatic nails). Verify that the dimensions of the supporting members are sufficient to receive the specified fasteners. All product modifications will void the warranty unless prior written consent from MiTek has been obtained.
- 5) Some connector models are listed more than once to indicate installation and/or fastener options.
- 6) New products or updated product information are designated in **blue**.
- 7) Throughout this catalog, dimensions are expressed in inches and loads in pounds unless specifically noted otherwise.
- 8) Some MiTek products show both nail fastening and bolt schedules. In those cases, specific loads for each has been identified. Nail and bolt values cannot be combined unless noted otherwise.
- 9) Load values for 8d, 10d, 16d, and 20d designations in the fastener schedules throughout this catalog refer to common wire nails unless noted otherwise. Nails shall conform to a recognized national standard, such as ASTM F1667, as prescribed by the model building codes.
- 10) Diamond holes are for optional nailing for maximum listed capacity or for temporary hanger fastening during installation.
- 11) Fastener installation may cause wood to split and reduce a fastener's ability to transfer loads into the supporting member. **If wood splitting occurs, consider pre-drilling holes not exceeding 75% of the nail diameter (per the National Design Specification for Wood Construction (NDS) Section 12.1.5.3).**
- 12) Bolts specified in this catalog are through-bolts and must conform to requirements for ASTM A 307 Grade A, or ASME SAE Grade 2, or better unless noted otherwise.
- 13) Anchor Bolts must conform to ASTM F 1554.
- 14) MiTek connectors listed in this catalog are manufactured for specific sizes of standard dimensional lumber, plated trusses,

or structural composite lumber. **For applications involving unusual supporting conditions environments, contact MiTek. Wood shrinkage or expansion, caused by lack of moisture or excessive moisture, may adversely affect connector installation. Evaluate potential shrinkage or expansion to ensure proper connector installation and performance.**

- 15) The load values listed in this catalog are based on installation to wood with a moisture content of less than 19%, and used in dry service conditions. Load reductions, in accordance with the applicable local Building Code, shall be taken where wood moisture content is greater than 19% at the time of installation or where used in wet service conditions.
- 16) Unless otherwise noted, MiTek products may not be bent or cut for any reason unless prior written consent from MiTek has been obtained. **Field alterations may significantly reduce the published allowable load values in this catalog.**

Design Notes

- 1) Some products have allowable loads that can be applied in several directions (F1, F2, and uplift is a common example). When these products have F1, F2 and/or uplift loads applied simultaneously, it is necessary to make the following check:
$$\frac{F_1 \text{ applied}}{F_1 \text{ allowable}} + \frac{F_2 \text{ applied}}{F_2 \text{ allowable}} + \frac{\text{Uplift applied}}{\text{Uplift allowable}} \leq 1.0$$
As an alternative check for simultaneous loads in more than one direction for embedded truss anchors (pages 244-250), LUGT girder tiedowns (pages 253 and 257), hurricane angles and connectors (pages 255-256), and hurricane ties (pages 262-264); the applied load in each direction shall not exceed 75% of the listed allowable load in the corresponding direction.
- 2) Unless otherwise noted, the allowable loads shown in this catalog are based on Allowable Stress Design methodology. **Multiply seismic and wind ASD load values by 1.4 or 1.6 respectively to obtain LRFD values.**
- 3) Connector capacities may exceed the allowable capacity of the wood members involved in the connection. A qualified designer should verify that all wood members (supporting and supported) have been properly designed for the connector.
- 4) Verify that the size of the supporting member can accommodate the connector's specified fasteners.
- 5) Some illustrations in this catalog may not reflect additional mechanical reinforcements which may be required to reduce cross grain tension or wood member bending under loading. The design professional is responsible for determining if additional mechanical reinforcement is required during construction.
- 6) MiTek recommends the hanger height be 60% of the joist height for stability during construction.
- 7) Allowable loads of different connector models cannot be combined to resist loads at a single connection location. For special considerations, consult MiTek Customer Service

2018 NDS® Standards

Unless otherwise noted, the allowable load values presented in this catalog reflect the calculation criteria set forth in the 2018 National Design Specification for Wood Construction (NDS®) published by the American Forest and Paper Association; with the methodology prescribed in ICC-ES AC13 or other relevant acceptance criteria applied.

General Information

Material

MiTek selects steel for its various products in accordance with application needs and steel properties, including tensile strength, ductility, corrosion resistance, gauge, and weldability. See specific code evaluation reports or consult MiTek for additional steel information on specific products. Products are manufactured from steel which meets ASTM A 653, ASTM A 1011, or ASTM A 36, ASTM A1018 or ASTM A666 standards.

Testing and Product Design Loads

On all structurally-rated products, MiTek performs calculations and full-scale testing in accordance with ICC-ES AC13, ASTM D7147, and other applicable ICC-ES acceptance criteria and standards recognized by model code agencies. All testing is conducted or verified by an approved IAS accredited third-party testing laboratory which generates an independent test report. In accordance to these standards the design loads for joist hangers and similar devices listed are the lowest results obtained from one of the following methods:

- 1) The lowest ultimate tested load divided by three.
- 2) Average load producing 1/8" deflection.
- 3) Calculations based 2018 NDS® and applicable Standards.

The allowable loads for some products have been increased in accordance with the NDS® by applying a Load Duration Factor, C_D , for fasteners in wood. Stress increases have not been applied to steel components of the products.

Floor / Design Load 100% (no increase).

Roof Snow 115% of design load for 2-month duration of load

Roof Non-Snow 125% of design load for 7-day duration of load.

Uplift 160% of design load for wind/seismic loading

Spruce-Pine-Fir or Hem Fir Equivalent Capacity

Unless otherwise noted, the published design loads in this catalog apply to Douglas Fir-Larch or Southern Pine lumber. When Spruce-Pine-Fir or Hem Fir lumber is used with face mount hangers or straps, the allowable load capacity may be adjusted according to the chart below.

Allowable Load Adjustment Factor		
Wood Species	Specific Gravity	Adjustment Factor
Douglas Fir-Larch (DF)	0.50	1.00
Southern Pine (SP)	0.55	1.00
Douglas Fir (S) Hem Fir (N)	0.46	0.88
Spruce-Pine-Fir (S-P-F)	0.42	0.86

- 1) Allowable loads must be adjusted according to the applicable wood species.
- 2) When using structural composite lumber, verify wood species and use above listed adjustment factors.

THIS IS A REQUIREMENT ONLY FOR THE STATE OF CALIFORNIA.

Based on our experience, we do not believe that our products when used as intended present an exposure risk of ingestion, inhalation or by absorption through the skin to any of Prop 65's current list of chemicals. Nonetheless, out of an abundance of caution, and in the event our MiTek products are misused or used in ways we do not foresee, we are taking the precaution of placing a short-form Prop 65 warning on the labels of our retail packaged products, and in some instances, on signs posted in the California retail locations where our products are sold to consumers without labels.

Installation Notes

- 1) Use proper safety equipment during connector installations. Always wear gloves when handling connectors.
- 2) All welding should be done in accordance with the American Welding Society (AWS) Standard by a certified welder. **Caution: Welding galvanized steel may produce harmful fumes and should only be performed in well-ventilated environments.**
- 3) The proper type and quantity of fasteners must be used to install MiTek products. To achieve the published allowable loads, install with the fasteners specified for that particular product. Some products allow for alternate nail installations. Refer to the "Optional Nails for Face Mount Hangers and Straight Straps" chart on page 22 of this catalog for load adjustments when using alternate nailing. All specified fasteners must be properly installed prior to applying load to the connection.
- 4) Drill bolt holes a minimum of 1/32" and a maximum of 1/16" larger than the diameter of the bolt to be installed (per the 2018 NDS®, Section 11.1.3).
- 5) Washers should always be used under the head or nut of a bolt when not in contact with the connector unless noted otherwise.
- 6) It may be permissible to install some connectors with TECO pneumatic nails provided the nail length and diameter are the same and are installed through all pre-punched nail holes. MiTek recommends the use of nail guns featuring hole-locating mechanisms. Please note that many nail guns use fasteners that are shorter than the common nail size and load reductions will result. Contact MiTek Engineering. **Caution: Always follow nail gun manufacturer's safety guidelines.**
- 7) Joists installed in hangers should bear fully on the connector seat and shall be cut to fit against the header with a gap no greater than 1/8" between the joist end and header face.
- 8) Multiple-ply members must be properly fastened together to distribute loads as a single member.
- 9) Top mount hangers shall be installed with the back of the hanger tight to the face of the header.
- 10) Top mount hangers installed in floor systems may produce unevenness. This will vary based on thickness of the top flange and nail heads. **If a problem is anticipated, the effects can be mitigated by dapping or notching the beam or cutting the subfloor at hanger locations. Face mount hangers will eliminate this problem.**

MiTek manufactures and supplies some products that are not intended as consumer products, and are sold through professional construction supply channels and/or delivered directly to job sites. These products will not carry the Prop 65 warning. To learn more about the California Proposition 65, visit www.P65Warning.ca.gov. For MiTek specific questions please contact MiTek Customer Service at 800-328-5934 with any questions or visit our website, MiTek-US.com.

FASTENERS



FASTENERS

22-39

Bolts	38
Fastening Identification / Features	39
Nails	22-24
Screws	25-37



N / NA Nails

Fasteners

Proper fasteners are a critical component in a sound wood frame structure. To ensure successful installations of its connectors, MiTek offers a full range of structurally-rated nails. All galvanized nails supplied by MiTek are Hot-dipped for greater corrosion resistance. Any MiTek connector requiring a NA16D-RS or NA20D nail is shipped with the nails attached to the connector in convenient poly bags.

Finish: See Nail Specification Table on page 23.

Materials: ASTM A 123; ASTM A 153 (HDG)

Installation:

- Allowable shear values assume nail embedment into the wood of the entire nail or 10 nail diameters (whichever is less). Otherwise, the nail must be embedded at least 6 nail diameters, with the load reduced using the equation below:

$$\text{Reduced Load} = \frac{\text{Published Load} \times \text{Actual Penetration}}{\text{Nail Diameter} \times 10}$$

- Load reductions may occur if nails are used other than those specified. See the chart [Optional Nails for Face Mount Hangers](#) below for load reduction factors regarding nail substitutions.
- For pneumatic nail use, see Installation Notes on page 19 and reference MiTek's technical bulletins.

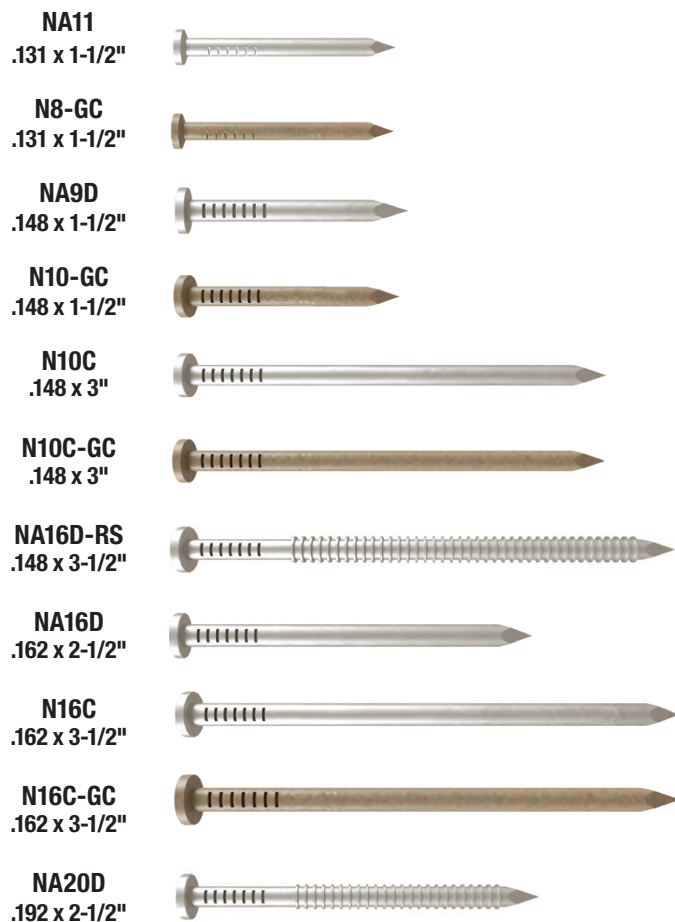

Continued on next page

Optional Nails for Face Mount Hangers and Straight Straps

Reductions are taken from appropriate DF value found in the load chart.

(excludes slant nail hangers)

Catalog Nail	Replacement Fastener ¹	Allowable Load Adjustment Factor		
		DF	SP	S-P-F
8d x 1-1/2 (0.131" x 1-1/2")	8d x 1-1/2 (0.131" x 1-1/2")	1.00	1.00	0.87
	No. 8 (0.164") x 1-1/2 Wood Screw	0.96	1.00	0.83
8d common (0.131" x 2-1/2")	8d Box (0.113" x 2-1/2")	0.77	0.83	0.67
	8d x 1-1/2 (0.131" x 1-1/2")	1.00	1.00	0.87
	No. 8 (0.164") x 1-1/2 Wood Screw	0.96	1.00	0.83
10d x 1-1/2 (0.148" x 1-1/2")	8d x 1-1/2 (0.131" x 1-1/2")	0.83	0.90	0.72
	No. 8 (0.164") x 1-1/2 Wood Screw	0.80	0.87	0.69
10d common (0.148" x 3")	8d Box (0.113" x 2-1/2")	0.64	0.69	0.55
	10d Sinker (0.120" x 2-7/8")	0.71	0.76	0.61
	8d common (0.131" x 2-1/2")	0.83	0.90	0.72
	10d Box (0.128" x 3")	0.80	0.87	0.69
	8d x 1-1/2 (0.131" x 1-1/2")	0.83	0.90	0.72
	10d x 1-1/2 (0.148" x 1-1/2")	1.00	1.00	0.87
	10d x 2-1/2 (0.148" x 2-1/2")	1.00	1.00	0.87
	16d Sinker (0.148" x 3-1/4")	1.00	1.00	0.87
12d common (0.148" x 3-1/4")	No. 8 (0.164") x 1-1/2 Wood Screw	0.80	0.87	0.69
	10d x 1-1/2 (0.148" x 1-1/2")	1.00	1.00	0.87
	16d Sinker (0.148" x 3-1/4")	1.00	1.00	0.87
16d common (0.162" x 3-1/2")	No. 8 (0.164") x 1-1/2 Wood Screw	0.67	0.73	0.58
	8d common (0.131" x 2-1/2")	0.70	0.76	0.61
	10d Box (0.128" x 3")	0.67	0.73	0.58
	10d common (0.148" x 3")	0.84	0.91	0.73
	12d common (0.148" x 3-1/4")	0.84	0.91	0.73
	10d x 1-1/2 (0.148" x 1-1/2")	0.84	0.91	0.73
	10d x 2-1/2 (0.148" x 2-1/2")	0.84	0.91	0.73
	10d Sinker (0.148" x 2-7/8")	0.60	0.65	0.52
	16d Box (0.135" x 3-1/2")	0.74	0.80	0.65
	16d Sinker (0.148" x 3-1/4")	0.84	0.91	0.73
	16d x 2-1/2 (0.162" x 2-1/2")	1.00	1.00	0.86

1) No. 8 x 1-1/2 Wood Screw shall conform to ANSI/ASME Standard B18.6.1-1981.

2) This chart does not apply to HUS, JDS, JH, JPF, JUS, MSH, MUS or THDH slant nail hangers.

How to Use:

The base value is the catalog listed nail in Douglas Fir-Larch and the adjustment factor is the multiplier for the applicable replacement nail and wood combination.

- Adjustment factors may vary with some custom hangers or steel thicker than 10 gauge. Contact MiTek for exceptions.
- Roofing nails shall not be substituted for any nail size or type.



Optional Nails Example:

JL210 – listed load is 1650 lbs. @ 100% for 10d common nails.

If substituting:

8d common nails with DF-L or LVL:

1650 lbs. x .83 = 1369 lbs.

8d common nails with SP:

1650 lbs. x .90 = 1485 lbs.

8d common nails with S-P-F:

1650 lbs. x .72 = 1188 lbs.

No further reductions are required.

Nail Specification Table

Finish ^{3,7}	Size	MiTek Stock No. ⁷	Ref. No.	Dimensions (in)		Nails Per Lb.	DF/SP Allowable Shear per Nail (Lbs.) ^{1,2,4,5}										Withdrawal Load (Lbs/in) ⁶	Corrosion Finish
				Nail Diameter	Length		Steel Gauge											
							3	7	10	12	14	16	18	20	22			
HDG	8d x 1-1/2	NA11	N8	0.131	1-1/2	152	--	--	--	--	--	96	95	94	94	32		
	10d x 1-1/2	NA9D	N10	0.148	1-1/2	100	--	--	139	127	119	116	114	114	113	36		
	10d Common	N10C	10DHDG	0.148	3	70	--	--	158	139	127	119	116	114	113	36		
	16d x 2-1/2	NA16D	N16, N16EG	0.162	2-1/2	66	194	181	161	149	141	138	137	136	--	40		
	16d Common	N16C	16DHDG	0.162	3-1/2	48	194	181	161	149	141	138	137	136	--	40		
	20d x 2-1/2	NA20D	--	0.192	2-1/2	41	234	207	187	175	168	--	--	--	--	47		
GC	8d x 1-1/2	N8-GC	--	0.131	1-1/2	152	--	--	--	--	--	96	95	94	94	32		
	10d x 1-1/2	N10-GC	--	0.148	1-1/2	118	--	--	139	127	119	116	114	114	113	36		
	10d Common	N10C-GC	--	0.148	3	70	--	--	158	139	127	119	116	114	113	36		
	16d Common	N16C-GC	--	0.162	3-1/2	48	194	181	161	149	141	138	137	136	--	40		
SS ⁸	8d x 1-1/2	SSNA8D	SSN8	0.131	1-1/2	147	--	--	--	--	--	96	95	94	94	32		
	10d x 1-1/2	SSNA10D	SSN10	0.148	1-1/2	126	--	--	139	127	119	116	114	114	113	24		
	8d Common	SSN8C	SS8D	0.131	2-1/2	94	--	--	--	--	--	99	96	95	94	22		
	10d Common	SSN10C	SS10D	0.148	3	67	--	--	158	139	127	119	116	114	114	113	24	
	16d Common	SSN16C	SS16D	0.162	3-1/2	44	194	181	161	149	141	138	137	136	136	27		
Bright	8d Common	8d Common	--	0.131	2-1/2	126	--	--	--	--	99	96	95	94	94	32		
	10d Common	10d Common	--	0.148	3	70	--	--	158	139	127	119	116	114	114	113	36	
	16d Sinker	16d Sinker	--	0.148	3-1/4	60	162	158	139	127	119	116	114	114	--	36		
	16d Ring Shank	NA16D-RS	--	0.148	3-1/2	57	183	168	150	--	--	--	--	--	--	36		
	16d Common	16d Common	--	0.162	3-1/2	48	194	181	161	149	141	138	137	136	--	40		
	20d Common	20d Common	--	0.192	4	29	234	207	187	175	168	--	--	--	--	47		

- 1) Loads are calculated to specifications of Part 12 of the National Design Specifications for Wood Construction (NDS®), 2018 Edition.
- 2) Loads apply to Douglas Fir (G=0.50) and Southern Pine (G=0.55). For Spruce-Pine-Fir (G=0.42) multiply above values by 0.86. For other wood types refer to NDS or consult MiTek.
- 3) HDG = Hot-Dip Galvanized; SS = Stainless Steel; GC = Gold Coat; Bright = No Finish.
- 4) For 3 gauge steel with Fu=58,000 psi and 7 gauge thru 22 gauge steel with Fu=45,000 psi. Shear values assumes full penetration of at least 10 nail diameters.
- 5) Fastener values may be increased for duration of load.
- 6) Withdrawal loads are in pounds (lbs) per linear inch of embedment into main member.
- 7) Bright finish common and sinker nails are listed in table for reference only. MiTek does not stock these type nails.
- 8) Stainless steel 8d x 1-1/2 nails are ring shank. Other stainless steel nail sizes in table are smooth shank, and withdrawal values are in accordance with Table 12.2D of the 2018 NDS.

Corrosion Finish Key
■ Stainless Steel ■ Gold Coat
■ HDG ■ Triple Zinc

Minimum Fastener Penetration Table

Nail Penny	Wire Gauge	Shank Diameter (in)	Minimum Penetration for Full Shear Load (in)	Minimum Penetration for Reduced Shear Load ¹ (in)
6d	11-1/2	.113	1.13	0.68
8d	10-1/4	.131	1.31	0.79
10d	9	.148	1.48	0.89
12d	9	.148	1.48	0.89
16d Sinker	9	.148	1.48	0.89
16d	8	.162	1.62	0.97
20d	6	.192	1.92	1.15

- 1) For penetration less than this distance, the nail has no value.
- 2) Penetrations are derived according to the 2018 NDS.



Copyright © 2022 MiTek Industries, Inc. All Rights Reserved



Reduced Fastener Penetration Example (See chart above):

HD210 (Min) – listed load is 1540 lbs. @ 100% for 16d common nails.

Reduced HD210 capacity if using a 2x DF-L or SP header:

$$\frac{1540 \text{ lbs.} \times 1.5}{1.62} = 1425 \text{ lbs.} @ 100\%$$

The WS Wood Screw is a self-drilling screw used for numerous interior framing applications. For use in wood-to-wood and steel-to-wood applications. Head stamped to indicate length for easy inspection.

Features and Benefits:

- 1/4" diameter
- No predrilling
- Type 17 point reduces installation torque and splitting
- 3/8" Hex Drive
- Length identification stamps on all WS heads

Materials: 1/4" diameter Grade 5 steel

Finish: Yellow Zinc

Codes: IBC, FL, LA

Installation:

- Screws are self-drilling.
- Install using a low speed clutch drill with 3/8" hex head driver. The washer head should be flat to the surface and the serrations will oppose turning and release the clutch. Do not over-tighten the screws.
- Care should be given to ensure the fastener is installed perpendicular to the plane of the side plate.

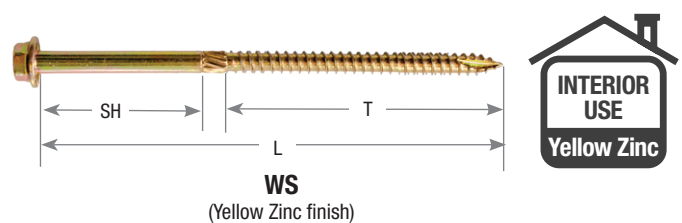

Specification Table

Size (in)	MiTek Stock No.	Ref. No.	Dimensions (in)				Finish ¹	DF/SP Allowable Loads (Lbs.) ^{2,4}						S-P-F Allowable Loads (Lbs.) ^{2,4}						Code Ref.	
			L	SH	T	Wood-to-Wood ³		Shear (100%)			Withdrawal Capacity (Lbs/in of thread)	Steel-to-Wood Withdrawal Capacity (Lbs.) ⁵	Shear (100%)				Withdrawal Capacity (Lbs/in. of thread)	Steel-to-Wood Withdrawal Capacity (Lbs.) ⁵			
								Steel-to-Wood					Steel-to-Wood								
								Gauge					Gauge								
14	10	7	3	100%	100%	Wood-to-Wood ³	14	10	7	3	100%	100%									
1/4 x 1-1/2	WS15	--	1-1/2	1/4	1-1/4	Zinc	--	230	261	259	266	164	206	--	188	211	190	217	103	129	IBC, FL, LA
1/4 x 2	WS2	--	2	1/4	1-3/4	Zinc	--	306	307	289	316	160	281	--	215	244	249	248	117	204	
1/4 x 2-1/2	WS25	--	2-1/2	1/4	2	Zinc	--	362	352	338	369	199	398	--	256	292	286	294	141	281	
1/4 x 3	WS3	--	3	3/4	2	Zinc	268	418	396	387	457	199	398	227	297	340	322	365	141	281	
1/4 x 3-1/2	WS35	--	3-1/2	3/4	2-1/2	Zinc	398	451	460	454	481	208	520	311	338	380	356	370	154	385	
1/4 x 4-1/2	WS45	--	4-1/2	1-1/4	3	Zinc	415	516	588	589	531	214	642	364	421	460	425	379	163	489	
1/4 x 5	WS5	--	5	1-3/4	3	Zinc	415	516	588	589	531	214	642	364	421	460	425	379	163	489	
1/4 x 6	WS6	--	6	1-3/4	4	Zinc	415	516	588	589	531	214	642	364	421	460	425	379	163	489	
1/4 x 8	WS8	--	8	4-3/4	3	Zinc	415	516	588	589	531	214	642	364	421	460	425	379	163	489	

1) Zinc = Yellow Zinc Dichromate.

2) Allowable shear loads assume a side plate tensile strength of 45 ksi for 14 gauge and 10 gauge, 52 ksi for 7 gauge and 58 ksi for 3 gauge.

3) Shear loads for wood-to-wood connections assume a side member thickness of 1-1/2".

4) Loads are for 100% duration of load factors, and may be increased for other duration factors in accordance with the NDS.

5) Withdrawal loads for steel-to-wood connections assume a side plate thickness of 1/4" or less.

Packaging Table

Use	Size (in)	Retail Box Offering		Mini Bulk Offering		Bulk Offering	
		MiTek Stock No.	Box/Ctn Qty	MiTek Stock No.	Box/Ctn Qty	MiTek Stock No.	Box/Ctn Qty
Interior for wood-to-wood connections	1/4 x 1-1/2	WS15-R25	12-pack/25-ea	WS15-MB	3-box/300-ea	WS15-BP	1500-ea
	1/4 x 2	WS2-R25	12-pack/25-ea	WS2-MB	3-box/250-ea	WS2-BP	1300-ea
	1/4 x 2-1/2	WS25-R25	12-pack/25-ea	WS25-MB	3-box/200-ea	WS25-BP	1100-ea
	1/4 x 3	WS3-R25	12-pack/25-ea	WS3-MB	3-box/150-ea	WS3-BP	950-ea
	1/4 x 3-1/2	WS35-R10	12-pack/10-ea	WS35-MB	3-box/125-ea	WS35-BP	900-ea
	1/4 x 4-1/2	WS45-R10	12-pack/10-ea	WS45-MB	3-box/100-ea	WS45-BP	800-ea
	1/4 x 5	WS5-R10	12-pack/10-ea	WS5-MB	3-box/100-ea	WS5-BP	500-ea
	1/4 x 6	WS6-R10	12-pack/10-ea	WS6-MB	3-box/100-ea	WS6-BP	600-ea
1/4 x 8	WS8-R10	12-pack/10-ea	--	--	--	WS8-BP	400-ea

The MiTek Washer Head is the ideal screw for interior Multi-Ply EWP and dimensional wood connections. The specific lengths of the WSWH allow for one-sided connections on multi-ply beams and girder trusses.

Features and Benefits:

- 1/4" diameter
- No predrilling
- Flat head style allows for less interference after installation
- Type 17 point reduces installation torque and splitting
- T30* drive eliminates cam-out
- Nibs under head seat head flush to wood surface
- Length identification stamps on all WSWH heads

Materials: 1/4" diameter Grade 5 steel

Finish: Yellow Zinc

Codes: IBC, FL, LA



Installation:

- For best results, install the MiTek Washer Head using a high torque, 1/2" variable speed drill.
- Bring the washer portion of head flush to the surface of the wood. **Do not overdrive.**

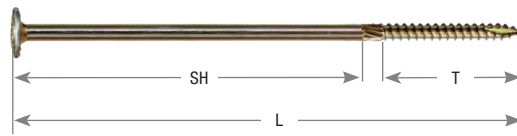

Specification Table

Size (in)	MiTek Stock No.	Ref. No.	Dimensions (in)			Finish ¹	DF/SP		SPF		LVL		Code Ref.
			L	SH	T		Allowable Loads (Lbs.) ⁴		Allowable Loads (Lbs.) ⁴		Allowable Loads (Lbs.) ⁴		
							Wood-to-Wood	Wood-to-Wood	Wood-to-Wood	Wood-to-Wood	Wood-to-Wood	Wood-to-Wood	
Wood-to-Wood Connections													
1/4 x 2-7/8	WSWH278	SDW22300	2-7/8	5/8	2	Zinc	268	274	227	194	--	--	IBC, FL, LA
1/4 x 4-1/2	WSWH45	SDW22458	4-1/2	2-1/4	2	Zinc	415	398	364	282	358	382	
1/4 x 5	WSWH5	SDW22500	5	2-3/4	2	Zinc	415	398	364	282	358	382	
1/4 x 6	WSWH6	SDW22600	6	3-3/4	2	Zinc	415	398	364	282	358	382	
Multi-Ply EWP Connections													
1/4 x 3-3/8	WSWH338	SDW22338	3-3/8	1-1/8	2	Zinc	398	373	311	264	319	310	IBC, FL, LA
1/4 x 5	WSWH5	SDW22500	5	2-3/4	2	Zinc	415	398	364	282	358	382	
1/4 x 6-3/4	WSWH634	SDW22634	6-3/4	4-1/2	2	Zinc	415	398	364	282	358	382	
Multi-Ply Dimensional Connections													
1/4 x 2-7/8	WSWH278	SDW22300	2-7/8	5/8	2	Zinc	268	274	227	194	--	--	IBC, FL, LA
1/4 x 4-1/2	WSWH45	SDW22458	4-1/2	2-1/4	2	Zinc	415	398	364	282	358	382	
1/4 x 6	WSWH6	SDW22600	6	3-3/4	2	Zinc	415	398	364	282	358	382	
1/4 x 6-3/8	WSWH638	SDW22638	6-3/8	4-1/8	2	Zinc	415	398	364	282	358	382	

1) Zinc = Yellow Dichromate.

2) Shear and withdrawal loads for wood-to-wood connections assume a side member thickness of 1-1/2" for DF/SP and SPF allowable loads and 1-3/4" for LVL allowable loads.

3) Withdrawal loads are derived from the minimum of head pull through tests and withdrawal capacity of threaded portion in main member.

4) Load are for 100% duration of load, and may be increased for the other duration factors in accordance with the NDS.

Packaging Table

Use	Size (in)	50-count Pack ¹		Mini Bulk Offering ¹		Bulk Offering ¹	
		MiTek Stock No.	Box/Ctn Qty	MiTek Stock No.	Box/Ctn Qty	MiTek Stock No.	Box Qty
Interior for Multi-Ply EWP & Multi-Ply Truss Girders	1/4 x 2-7/8	WSWH278-R50	5-box/50-ea	--	--	WSWH278-BP	500-ea
	1/4 x 3-3/8	WSWH338-R50	5-box/50-ea	WSWH338-MB	200-ea	--	--
	1/4 x 4-1/2	WSWH45-R50	5-box/50-ea	--	--	WSWH45-BP	400-ea
	1/4 x 5	WSWH5-R50	5-box/50-ea	WSWH5-MB	200-ea	--	--
	1/4 x 6	WSWH6-R50	5-box/50-ea	--	--	WSWH6-BP	300-ea
Truss Girders	1/4 x 6-3/8	WSWH638-R50	5-box/50-ea	--	--	WSWH638-BP	300-ea
	1/4 x 6-3/4	WSWH634-R50	5-box/50-ea	WSWH634-MB	200-ea	--	--

1) T30* drive is included in packaging.

* T30 is a trademark of Acument

Attaching 2x Ledger-to-Wall Studs Application

MiTek's WSWH Washer Head Structural Wood Screw can be used to attach a ledger to studs directly, through 1/2" APA rated sheathing or through one or two layers of 5/8" gypsum wallboard (drywall). Screws are to be installed into the wide face of the single 2x stud, through the gypsum board and into the center of the narrow face of the 2x stud.

Installation:

- Ledger design to be performed by a certified design professional.
- Locate studs in wall where ledger is to be installed.
- Install MiTek's WSWH5 structural wood screws through ledger and 5/8" gypsum wallboard into wall framing using a T30* drive.
- Follow the minimum edge distance guidelines in images shown below.
- Wall design must be performed by certified design professional.
- Care should be taken to install the ledger only where studs are plumb and free of any defects.
- **WSWH45 should be used when no gypsum wallboard is present.**

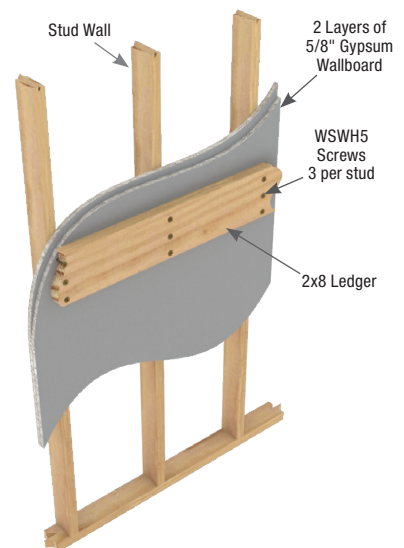

Typical 2x8 Ledger attached through 2 layers of 5/8" Gypsum Wallboard installation

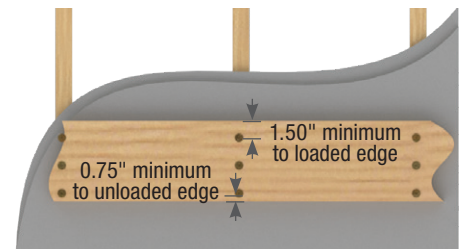
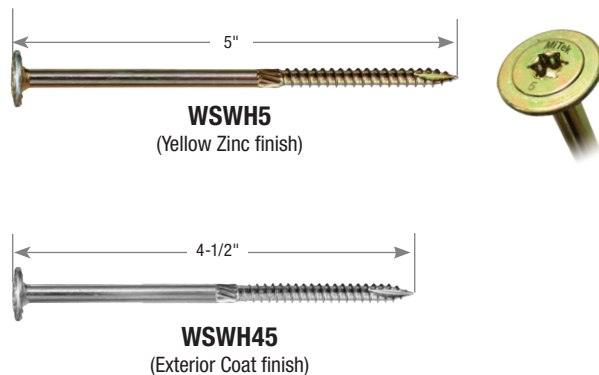

2x8 Detail

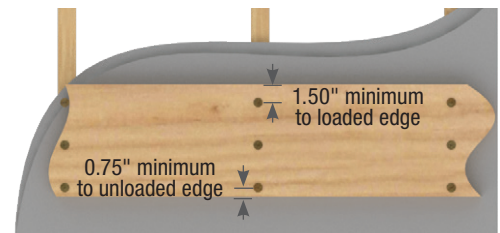

2x10 Detail

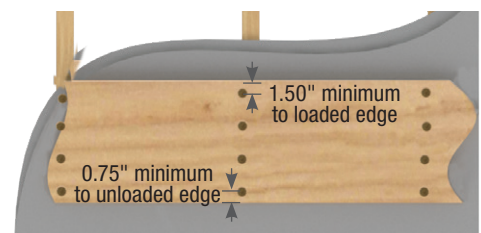

2x12 Detail

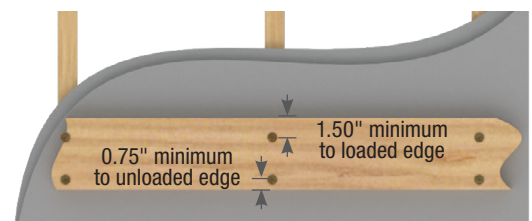

2x6 Detail

MiTek Stock No.		Ledger Size ⁹	Number of Screws per Stud ^{4,8}	Allowable Shear Per Stud (Lbs.) ^{2,5,6,7}	
Zinc Finish ¹	EXT Finish ¹			DF/SP SG ≥ 0.50	S-P-F/HF 0.42 ≤ SG < 0.50
WSWH45	WSWH45-EXT	2x6	2	520	455
WSWH5	WSWH5-EXT	2x8 or 2x10	3	860	750
		2x12	4	1040	900

- 1) Zinc = Yellow Zinc Dichromate; EXT = Exterior Coat.
- 2) Allowable loads are based on DF or equivalent wood members with a specific gravity ≥ 0.50, or SPF/HF members with specific gravity in the following range: 0.42 ≤ SG < 0.50.
- 3) Gypsum board must be attached per building code requirements.
- 4) Screws must be installed in the center of the 2x stud, with a tolerance of 3/16" to either side. Minimum loaded end distance for the stud is 3" and 6" when loaded away from the end. Ledger end distance must be 6" or greater for full values. For ledger end distances between 2" and 6" use 50% of the load table, for end distance between 2" and 4" predrill with a 5/32" bit.
- 5) The values above can be used when designing a ledger connection with (1) or (2) layers of 5/8" gypsum board, a direct connection with no gypsum between the ledger and studs, or a ledger connection with a single layer of APA rated 1/2" OSB.
- 6) Allowable loads are shown above at a load duration factor of C_D = 1.00. Loads may be increased where applicable to the current NDS. When in-service moisture content is greater than 19%, use C_M = 0.70.
- 7) For LRFD values, the values above should be adjusted in accordance with the 2018 NDS, Section 11.3.
- 8) Main members (stud) shall be loaded parallel to grain with a minimum penetration of 2-1/4" while side members (ledger) shall be loaded perpendicular to grain with a minimum penetration of 1-1/2".

* T30 is a trademark of Acument

Joining Multi-Ply Dimensional Lumber Beams Application

The MiTek WSWH Structural Wood Screws have been designed specifically for use in joining wood members of multiple-ply dimensional lumber beams. Using a standard 1/2" low speed/high torque drill, install screws into the side of the outermost ply. As the threads fully engage the final ply, allow the underside of the washer head to pull the plies firmly together. Washer head will install flush with the surface of the wood, but do not overdrive as this may damage the beam. Refer to the information on page 29 for proper WSWH screw size selection and fastening pattern.

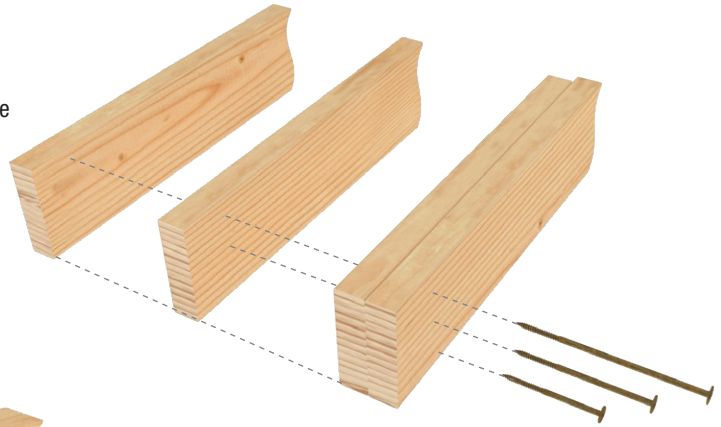

Minimum Spacing Requirements:

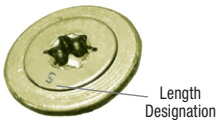
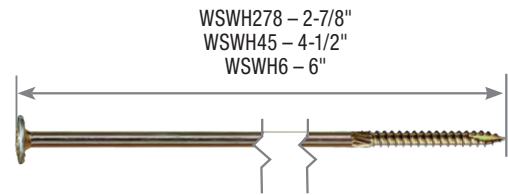
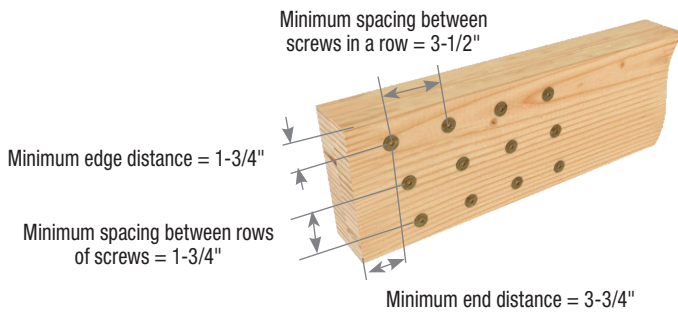

Fastener Identification

For easier selection and post installation inspection, all MiTek Structural Wood Screws carry an identifying head marking.

Top Loaded Beams

Where floor joists rest on all plies of the beam, WSWH screws should be installed in two staggered rows at 24" O.C. spacing. Maintain the minimum end and edge distance as indicated above.

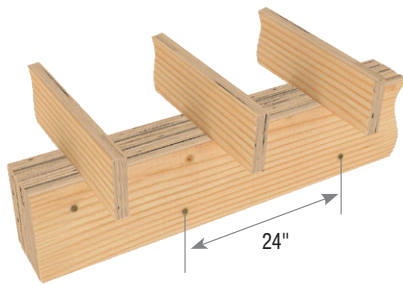

For beam depths of 18" or more, this pattern should be increased to three staggered rows of WSWH screws every 24" on center.

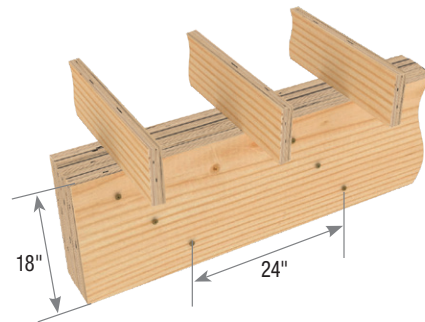

General Guidelines:

- Excessively warped or curved lumber should never be forced into alignment by use of clamps, screws or bolts as splitting may occur, potentially decreasing the carrying capacity of the beam.
- The WSWH278, WSWH45, and WSWH6 are not designed for use with engineered wood. Refer to MiTek's Joining Multi-Ply Engineered Wood (EWP) Beams Application information on page 30.
- A qualified designer or engineer should always be consulted for critical assemblies and fastening requirements.

Continued on next page

Fastener Size Selection by Assembly Type
(2 rows shown)

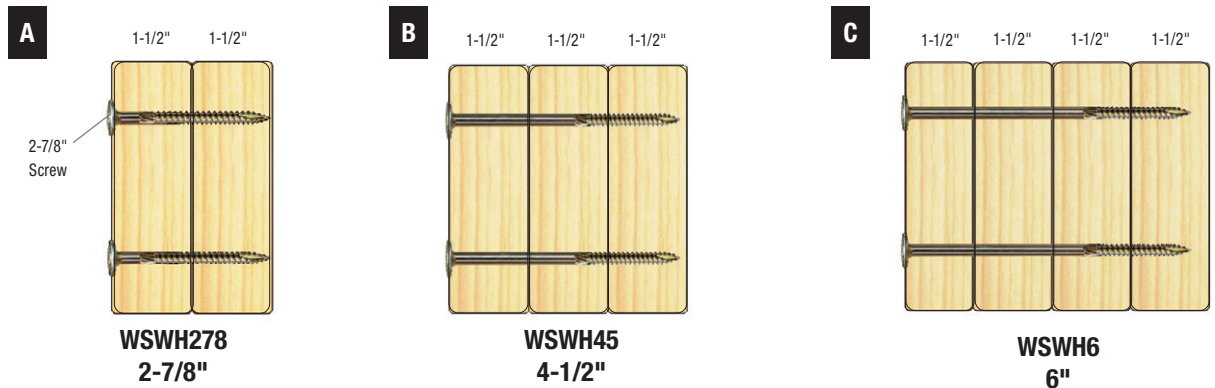

Side Loaded Beams

Where floor joists are joined to the side of the beam (typically using a joist hanger), this load chart must be used to establish the proper pattern based on the design load as determined by the engineer and noted on the plans.

Length (in)	MiTek Stock No.	No. of Screws Vertical Column	Spacing Between Screws in a Row (in)	Allowable Uniform Load Applied to Either Outside Member by Assembly Type (lbs/lineal ft) (See Graphics) ^{1,2,3,4,5,6}							
				DF/SP			SPF				
				A	B	C	A	B	C		
2-7/8	WSWH278	2	24	535	--	--	455	--	--		
			19.2	670			570				
			16	805			680				
		3	24	805	--	--	680	--	--		
			19.2	1005			850				
			16	1205			1020				
4-1/2	WSWH45	2	24	--	430	--	--	325	--		
			19.2	--			535			410	
			16	--			645			490	
		3	24	--	645	--	--	490	--		
			19.2	--			805			615	
			16	--			965			735	
6	WSWH6	2	24	--	--	380	--	--	290		
			19.2	--					475	365	
			16	--					570	435	
		3	24	--	--	570	--	--	435		
			19.2	--						715	545
			16	--						860	655
Head Side Multiplier ⁷				1.00	1.45	1.45	1.00	1.67	1.67		

- 1) Allowable loads are derived from tested fastener values as reported in ICC-ES ESR-2761.
 - 2) All numbers in this table are based on Douglas Fir-Larch (DF), Southern Pine (SP), and Spruce-Pine-Fir (SPF). The DF/SP values are based on SG ≥ 0.50. The SPF values are based on 0.42 ≤ SG < 0.50.
 - 3) The uniform loads in this table relate only to the capacity of the fastener to transfer shear loads between plies. The capacity of the beam may be less and should be verified by design professional.
 - 4) Values listed reflect 100% load duration. (C_D=1.0) The designer may apply adjustment factors to increase or decrease these loads per the NDS based on conditions for each assembly.
 - 5) To minimize rotation, 6" wide beams shall be side loaded only when loads are applied to both sides of the beam, with the lesser loaded side bearing at least 25% of the overall design load.
 - 6) **Load values depicted assume all uniform load is applied to the outermost ply.**
 - 7) **When the uniform load is applied to the outermost ply with the screw head, listed allowable loads can be multiplied by this value.**
- New products or updated product information are designated in **blue font**.

Copyright © 2022 MiTek Industries, Inc. All Rights Reserved

Joining Multi-Ply Engineered Wood (EWP) Beams Application

The MiTek WSWH Structural Wood Screws have been designed specifically for use in joining wood members of multiple-ply engineered wood beams (LVL, LSL & PSL). Using a standard 1/2" low speed/high torque drill, install screws into the side of the outermost ply. As the threads fully engage the final ply, allow the underside of the washer head to pull the plies firmly together. Washer head will install flush with the surface of the wood, but do not overdrive as this may damage the beam. Refer to the information below for proper WSWH screw size selection and fastening pattern.

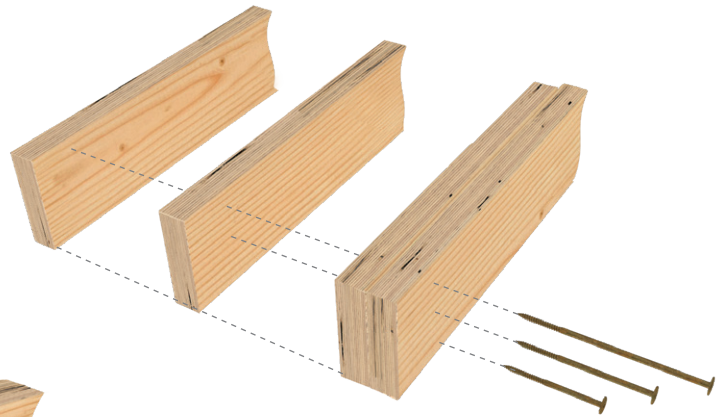

Minimum Spacing Requirements:

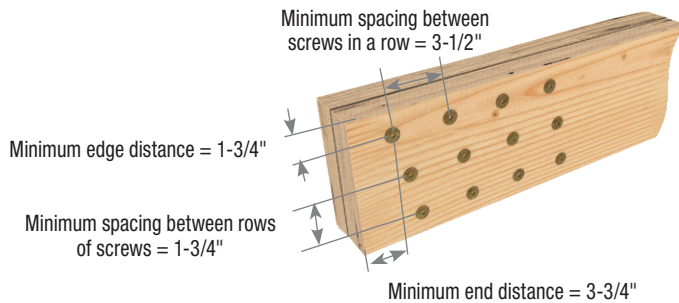

WSWH338 – 3-3/8"
 WSWH5 – 5-1/2"
 WSWH634 – 6-3/4"

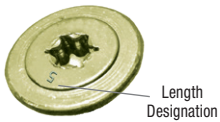
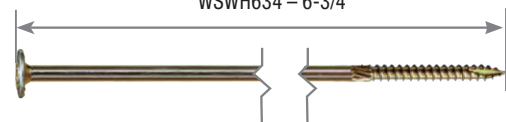

Fastener Identification

For easier selection and post installation inspection, all MiTek Wood Screws carry an identifying head marking.

Top Loaded Beams

Where floor joists rest on all plies of the beam, WSWH screws should be installed in two staggered rows at 24" O.C. spacing. Maintain the minimum end and edge distance as indicated above.

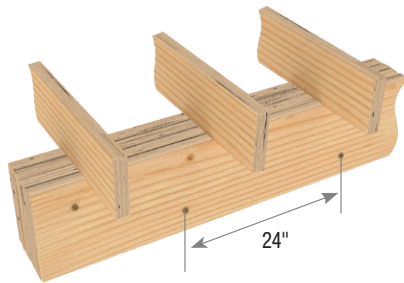

For beam depths of 18" or more, this pattern should be increased to three staggered rows of WSWH screws every 24" on center.

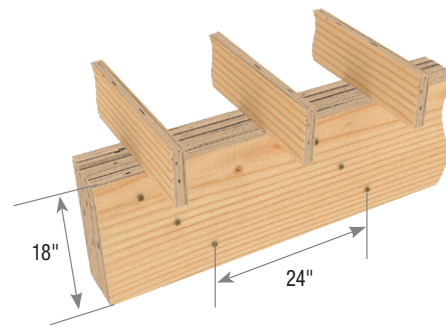

General Guidelines:

- Beams wider than 7" require special consideration by the design professional. The values on the next page do not apply.
- Excessively warped or curved LVL should never be forced into alignment by use of clamps, screws or bolts as splitting may occur, potentially decreasing the carrying capacity of the beam.
- The WSWH338, WSWH5, and WSWH634 are not designed for use with dimensional lumber. Refer to MiTek's Joining Multi-Ply Dimensional Lumber Beams Application information on page 28.
- A qualified designer or engineer should always be consulted for critical assemblies and fastening requirements.

Continued on next page

Fastener Size Selection by Assembly Type (2 rows shown)

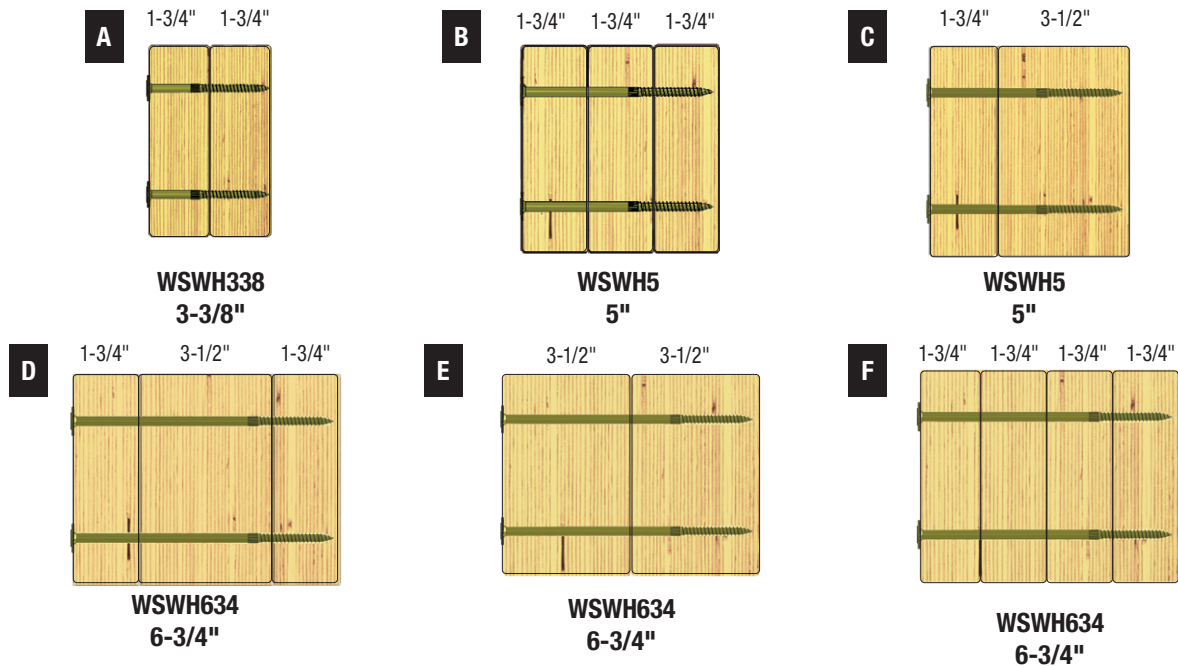

Side Loaded Beams

Where floor joists are joined to the side of the beam (typically using a joist hanger), this load chart must be used to establish the proper pattern based on the design load as determined by the engineer and noted on the plans.

Length (in)	MiTek Stock No.	No. of Screws Vertical Column	Spacing Between Screws in a Row (in)	Allowable Uniform Load Applied to Either Outside Member by Assembly Type (lbs/lineal ft) (See Graphics) ^{1,2,3,4,5}												
				EWP Wood Specific Gravity $G \geq 0.50$						EWP Wood Specific Gravity $G \geq 0.42$						
				A	B	C	D	E	F	A	B	C	D	E	F	
3-3/8	WSWH338	2	24	600							525					
			19.2	755	--	--	--	--	--		655					
			16	905							785					
			12	1205							1050					
		3	24	905							785					
			19.2	1130	--	--	--	--	--		985					
			16	1355							1180					
			12	1805							1570					
5	WSWH5	2	24		430	535						325	545			
			19.2		535	670						410	685			
			16		645	805						490	820			
			12		860	1075						655	1090			
		3	24		645	805						490	820			
			19.2		805	1005						615	1025			
			16		965	1210						735	1230			
			12		1285	1610						980	1640			
6-3/4	WSWH634	2	24				380	715	380					290	730	290
			19.2				475	895	475					365	910	365
			16				570	1075	570					435	1090	435
			12				765	1430	765					580	1455	580
		3	24				570	1075	570					435	1090	435
			19.2				715	1345	715					545	1365	545
			16				860	1610	860					655	1640	655
			12				1145	2150	1145					870	2185	870
Head Side Multiplier ⁶				1.06	1.25	1	1.25	1	1.25	1.19	1.67	1	1.67	1	1.67	

1) Allowable loads are derived from tested fastener values as reported in ICC-ES ESR-2761.

2) The uniform loads in this table relate only to the capacity of the fastener to transfer shear loads between plies. The specific gravity (SG) and the capacity of the EWP should be verified with manufacturer's literature.

3) Values listed reflect 100% load duration. ($C_D=1.0$) The designer may apply adjustment factors to increase or decrease these loads per the NDS based on conditions for each assembly.

4) Load values depicted assume all uniform load is applied to the outermost ply.

5) To minimize rotation, 7" wide beams shall be side loaded only when loads are applied to both sides of the beam with the lesser loaded side bearing at least 25% of the overall design load.

6) When the uniform load is applied to the outermost ply with the screw head, listed allowable loads can be multiplied by this value.

New products or updated product information are designated in blue font.

WS Hex Head Exterior Structural Wood Screws

Fasteners

The MiTek Hex Head is the ideal screw for numerous framing applications. It can be used in wood-to-wood and steel-to-wood applications.

Features and Benefits:

- 1/4" diameter
- No predrilling
- Type 17 point reduces installation torque and splitting
- 3/8" hex drive
- Length identification stamps on all WS heads

Materials: 1/4" diameter Grade 5 steel

Finish: Exterior Coat

Codes: IBC, FL, LA

Installation:

- Screws are self-drilling.
- Install using a low speed clutch drill with 3/8" hex head driver.
The washer head should be flat to the surface and the serrations will oppose turning and release the clutch. Do not over-tighten the screws.
- Care should be given to ensure the fastener is installed perpendicular to the plane of the side plate.
- Refer to page 34 for Attaching Deck Ledger to Rim Board Application.

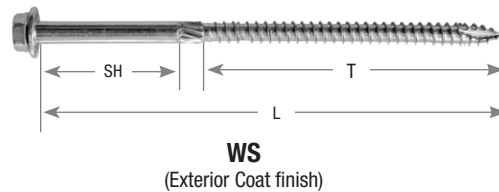

Specification Table

Size (in)	MiTek Stock No.	Ref. No.	Dimensions (in)				Finish ¹	DF/SP Allowable Loads (Lbs.) ^{2,4}					S-P-F Allowable Loads (Lbs.) ^{2,4}					Corrosion Finish	Code Ref.			
			L	SH	T	Wood-to-Wood ³		Shear (100%)				Withdrawal Capacity (Lbs/in. of thread)	Steel to Wood Withdrawal Capacity (Lbs.) ⁵	Shear (100%)						Withdrawal Capacity (Lbs/in. of thread)	Steel to Wood Withdrawal Capacity (Lbs.) ⁵	
								Steel-to-Wood						Wood-to-Wood ³	Steel-to-Wood							
								Gauge							Gauge							
14	10	7	3	100%	100%	14	10	7	3	100%	100%											
1/4 x 1-1/2	WS15-EXT	SDS25112	1-1/2	1/4	1-1/4	EXT	--	230	261	259	266	164	206	--	188	211	190	217	103	129		
1/4 x 2	WS2-EXT	SDS25200	2	1/4	1-3/4	EXT	--	306	307	289	316	160	281	--	215	244	249	248	117	204		
1/4 x 2-1/2	WS25-EXT	SDS25212	2-1/2	1/4	2	EXT	--	362	352	338	369	199	398	--	256	292	286	294	141	281		
1/4 x 3	WS3-EXT	SDS25300	3	3/4	2	EXT	268	418	396	387	457	199	398	227	297	340	322	365	141	281		
1/4 x 3-1/2	WS35-EXT	SDS25312	3-1/2	3/4	2-1/2	EXT	398	451	460	454	481	208	520	311	338	380	356	370	154	385		IBC, FL, LA
1/4 x 4-1/2	WS45-EXT	SDS25412	4-1/2	1-1/4	3	EXT	415	516	588	589	531	214	642	364	421	460	425	379	163	489		
1/4 x 5	WS5-EXT	SDS25500	5	1-3/4	3	EXT	415	516	588	589	531	214	642	364	421	460	425	379	163	489		
1/4 x 6	WS6-EXT	SDS25600	6	1-3/4	4	EXT	415	516	588	589	531	214	642	364	421	460	425	379	163	489		
1/4 x 8	WS8-EXT	SDS25800	8	4-3/4	3	EXT	415	516	588	589	531	214	642	364	421	460	425	379	163	489		

1) EXT = Exterior Coat.

2) Allowable shear loads assume a side plate tensile strength of 45 ksi for 14 gauge and 10 gauge, 52 ksi for 7 gauge and 58 ksi for 3 gauge.

3) Shear loads for wood-to-wood connections assume a side member thickness of 1-1/2".

4) Loads are for 100% duration of load factors, and may be increased for other duration factors in accordance with the NDS.

5) Withdrawal loads for steel-to-wood connections assume a side plate thickness of 1/4" or less.

Corrosion Finish Key

- Stainless Steel
- Gold Coat
- HDG
- Triple Zinc

Packaging Table

Use	Size (in)	Retail Box Offering ¹		50-count Pack ¹		Mini Bulk Offering ¹		Bulk Offering ¹	
		MiTek Stock No.	Box/Ctn Qty	MiTek Stock No.	Box/Ctn Qty	MiTek Stock No.	Box/Ctn Qty	MiTek Stock No.	Box Qty
Exterior for Deck Ledgers & other wood-to-wood connections	1/4 x 1-1/2	WS15-EXTR25	10-pack/25-ea	--	--	WS15-EXTMB	2-box/200-ea	WS15-EXTBP	1500-ea
		WS15-GCR25							
	1/4 x 2	WS2-EXTR25	10-pack/25-ea	--	--	WS2-EXTMB	2-box/200-ea	WS2-EXTBP	1300-ea
	1/4 x 2-1/2	WS25-EXTR25	10-pack/25-ea	--	--	WS25-EXTMB	2-box/200-ea	WS25-EXTBP	1100-ea
	1/4 x 3	WS3-EXTR25	10-pack/25-ea	WS3-EXTR50	5-box/50-ea	WS3-EXTMB	200-ea	WS3-EXTBP	950-ea
	1/4 x 3-1/2	WS35-EXTR12	10-pack/12-ea	WS35-EXTR50	5-box/50-ea	WS35-EXTMB	200-ea	WS35-EXTBP	900-ea
	1/4 x 4-1/2	WS45-EXTR12	10-pack/12-ea	WS45-EXTR50	5-box/50-ea	WS45-EXTMB	200-ea	WS45-EXTBP	800-ea
	1/4 x 5	WS5-EXTR12	10-pack/12-ea	WS5-EXTR50	5-box/50-ea	WS5-EXTMB	200-ea	WS5-EXTBP	600-ea
1/4 x 6	WS6-EXTR12	10-pack/12-ea	WS6-EXTR50	5-box/50-ea	WS6-EXTMB	200-ea	WS6-EXTBP	500-ea	
1/4 x 8	WS8-EXTR12	10-pack/12-ea	WS8-EXTR50	5-box/50-ea	WS8-EXTMB	200-ea	--	--	

The WSWH is an ideal alternative for the Pro or DIYer to traditional lag screws and through-bolts, for installing deck ledgers and more. It is easy to install and reduces labor on the jobsite. The large, flat washer head maximizes bearing area and allows for less interference after installation.

Features and Benefits:

- 1/4" diameter
- No predrilling
- Flat head style allows for less interference after installation
- Type 17 point reduces installation torque and splitting
- T30* drive eliminates cam-out
- Large washer maximizes bearing area
- Nibs under head seat head flush to wood surface
- Length identification stamps on all WSWH heads

Materials: 1/4" diameter Grade 5 steel

Finish: Exterior Coat

Codes: IBC, FL, LA

Installation:

- For best results, install the MiTek Washer Head using a high torque, 1/2" variable speed drill.
- Bring the washer portion of head flush to the surface of the wood.
Do not overdrive.
- See page 34 for Attaching Deck Ledger to Rim Board Application, page 27 for Attaching 2x Ledger-to-Wall Studs Application, page 28 for Joining Multi-Ply Dimensional Lumber Beams Application and page 30 for Joining Multi-Ply Engineered Wood (EWP) Beams Application.

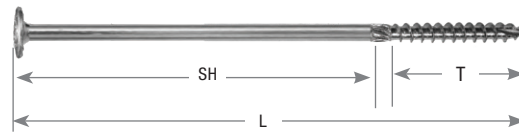

Specification Table

Size (in)	MiTek Stock No.	Ref. No.	Dimensions (in)			Finish ¹	DF/SP Allowable Loads (Lbs.) ⁴		SPF Allowable Loads (Lbs.) ⁴		LVL Allowable Loads (Lbs.) ⁴		Code Ref.
			L	SH	T		Wood-to-Wood		Wood-to-Wood		Wood-to-Wood		
							Shear ² 100%	Withdrawal ³ 100%	Shear ² 100%	Withdrawal ³ 100%	Shear ² 100%	Withdrawal ³ 100%	
Deck Ledger and Other Wood-to-Wood Connections													
1/4 x 2-7/8	WSWH278-EXT	SDWS22300DB	2-7/8	5/8	2	EXT	268	274	227	194	--	--	IBC, FL, LA
1/4 x 3-5/8	WSWH358-EXT	--	3-5/8	1-3/8	2	EXT	398	398	311	282	319	358	
1/4 x 4-1/2	WSWH45-EXT	SDWS22400DB	4-1/2	2-1/4	2	EXT	415	398	364	282	358	382	
1/4 x 5	WSWH5-EXT	SDWS22500DB	5	2-3/4	2	EXT	415	398	364	282	358	382	
1/4 x 6	WSWH6-EXT	SDWS22600DB	6	3-3/4	2	EXT	415	398	364	282	358	382	
1/4 x 8	WSWH8-EXT	SDWS22800	8	5-3/4	2	EXT	415	398	364	282	358	382	

1) EXT = Exterior Coat.

2) Shear and withdrawal loads for wood-to-wood connections assume a side member thickness of 1-1/2" for DF/SP and SPF allowable loads and 1-3/4" for LVL allowable loads.

3) Withdrawal loads are derived from the minimum of head pull through tests and withdrawal capacity of threaded portion in main member.

4) Load are for 100% duration of load, and may be increased for the other duration factors in accordance the NDS.

New products or updated product information are designated in **blue font**.

Packaging Table

Use	Size (in)	Retail Box Offering ¹		50-count Pack ¹		Mini Bulk Offering ¹	
		MiTek Stock No.	Box/Ctn Qty	MiTek Stock No.	Box/Ctn Qty	MiTek Stock No.	Box/Ctn Qty
Exterior for Deck Ledgers & other wood-to-wood connections	1/4 x 2-7/8	WSWH278-EXTR25	10-pack/25-ea	WSWH278-EXTR50	5-box/50-ea	WSWH278-EXTMB	200-ea
	1/4 x 3-5/8	WSWH358-EXTR12	10-pack/12-ea	WSWH358-EXTR50	5-box/50-ea	WSWH358-EXTMB	200-ea
	1/4 x 4-1/2	WSWH45-EXTR12	10-pack/12-ea	WSWH45-EXTR50	5-box/50-ea	WSWH45-EXTMB	200-ea
	1/4 x 5	WSWH5-EXTR12	10-pack/12-ea	WSWH5-EXTR50	5-box/50-ea	WSWH5-EXTMB	200-ea
	1/4 x 6	WSWH6-EXTR12	10-pack/12-ea	WSWH6-EXTR50	5-box/50-ea	WSWH6-EXTMB	200-ea
	1/4 x 8	WSWH8-EXTR12	10-pack/12-ea	WSWH8-EXTR50	5-box/50-ea	WSWH8-EXTMB	200-ea

1) T30* drive is included in packaging.

* T30 is a trademark of Acument

Attaching Deck Ledger to Rim Board Application

The MiTek WS structural wood screws can be used to fasten deck ledgers to the rim board (AKA band/rim joist) of structures to meet the connection requirements of the International Residential Building Code (IRC). Both the standard hex head (WS-EXT) and washer head (WSWH-EXT) styles may be used for this purpose. Table R507.9.1.3(1) of the 2018 IRC calls out lag screws for deck ledger attachment and the WS-EXT and WSWH-EXT may be used in place of the lag screws.

Installation:

1. Select the proper MiTek's WS-EXT or WSWH-EXT screw length. The threads should have full engagement with the rim board with the tip of the screw protruding and visible beyond the inside face of the rim board member. See **Section View** image.
2. With appropriate screw length selected, drive the screw through the ledger, sheathing, and rim board with a high torque variable speed drill.
3. Drive screw so head is firm and flush with surface of deck ledger, but do not overdrive.
4. Repeat these steps and install the appropriate number of screws at the prescribed edge, end distance, and spacing as called out in the table below and **Figure 1**.

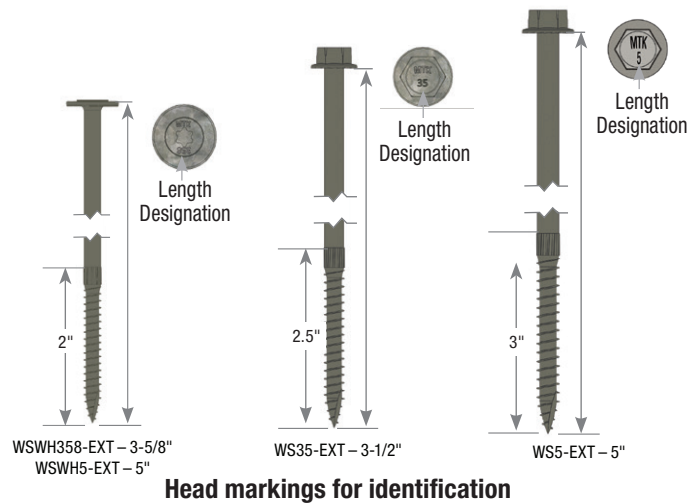

Head markings for identification

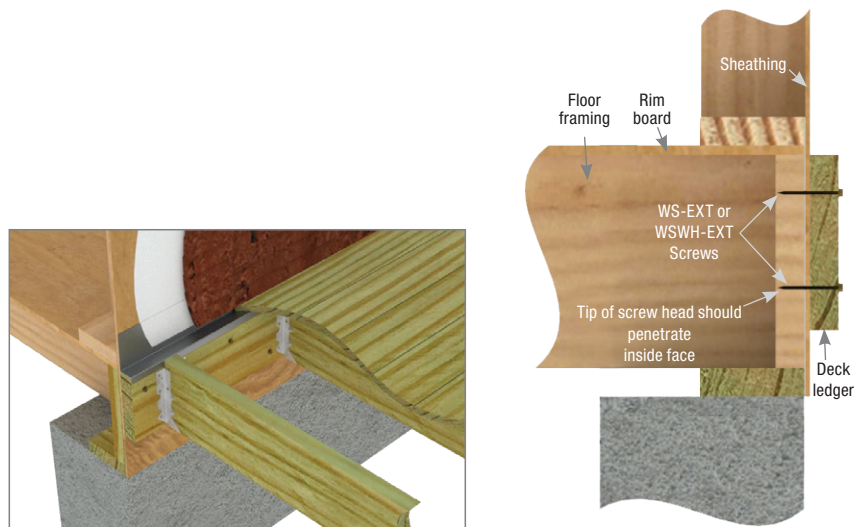

Perspective view

Section view

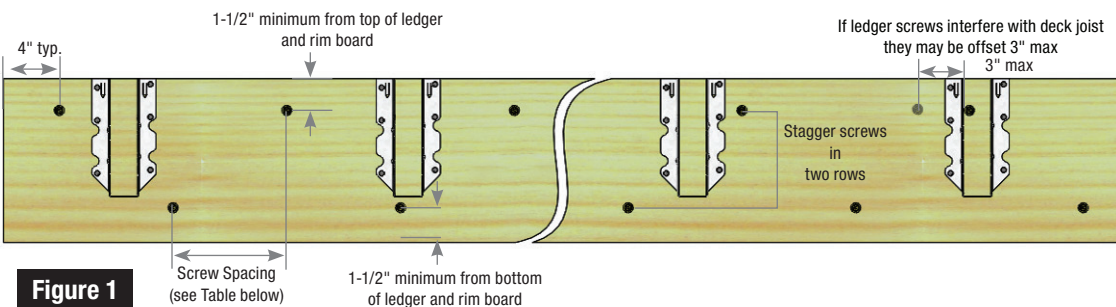

Figure 1

MiTek Stock No.	Ledger	Live Load	Rim Board	Spacing between WS-EXT / WSWH-EXT Screws based on Joist Span (in)						
				≤ 6-ft	≤ 8-ft	≤ 10-ft	≤ 12-ft	≤ 14-ft	≤ 16-ft	≤ 18-ft
WS35-EXT	DF-L / SP / SPF	40 psf	2" Nominal Solid Sawn	23	17	13	11	10	8	7
WSWH358-EXT			1" Min EWP	22	16	12	11	9	7	7
WS5-EXT	DF-L / SP / SPF	60 psf	2" Nominal Solid Sawn	16	12	9	7	7	5	5
WSWH5-EXT			1" Min EWP	15	11	8	7	6	5	5

- 1) Numbers are based on use of 3-1/2", 3-5/8" and 5" length screws.
- 2) Screw spacing based on requirements of 2018 IRC Section R507.9.1.3 and Table R507.9.1.3(1) and equivalent spacing of 1/2" diameter lag bolts. Stagger screws into 2 rows.
- 3) Multiple ledger plies should be fastened together to act as one unit independent of the WS-EXT or WSWH-EXT ledger attachment screws.
- 4) Solid Sawn Rim Board shall be Douglas Fir-Larch (DF-L), Southern Pine (SP), or Spruce-Pine-Fir (SPF), G ≥ 0.42.
- 5) 5" length screw shall be used for all 2 ply 2x ledger members.

The WSBH is a multi-purpose structural wood screw ideal for a low profile appearance in wood-to-wood connections. This structural wood screw allows the Pro Contractor or DIYer to drive the head flush or countersink it below the wood surface. The WSBH is easy to install and a high strength alternative to traditional lags, bolts and pole barn nails.

Features and Benefits:

- 1/4" diameter
- No predrilling
- Comparable to 1/2" Lag Screw
- Low profile head style can be driven flush or countersunk
- Type 17 point reduces installation torque and splitting
- T30* drive eliminates cam-out
- Length identification stamps on all WSBH heads

Materials: 1/4" diameter Grade 5 steel

Finish: Exterior Coat

Options: See chart for Corrosion Finish Options

Codes: IBC, FL, LA

Installation:

- For best results, install the MiTek Bugle Head using a high torque, 1/2" variable speed drill. Bring the washer portion of head flush to the surface of the wood or countersink.

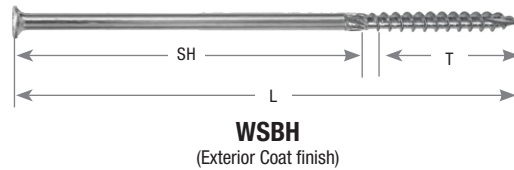

Specification Table

Size (in)	MiTek Stock No.	Ref. No.	Dimensions (in)			Finish ¹	DF/SP		SPF		LVL		Code Ref.
			L	SH	T		Allowable Loads (Lbs.) ⁴		Allowable Loads (Lbs.) ⁴		Allowable Loads (Lbs.) ⁴		
							Wood-to-Wood	Wood-to-Wood	Wood-to-Wood	Wood-to-Wood	Wood-to-Wood	Wood-to-Wood	
1/4 x 2-1/2	WSBH25-EXT	--	2-1/2	1/4	2	EXT	Shear ² 100%	Withdrawal ³ 100%	Shear ² 100%	Withdrawal ³ 100%	Shear ² 100%	Withdrawal ³ 100%	IBC, FL, LA
1/4 x 4	WSBH4-EXT	--	4	1-3/4	2	EXT	315	282	246	208	252	339	
1/4 x 6	WSBH6-EXT	--	6	3-3/4	2	EXT	328	282	288	208	283	339	
1/4 x 8	WSBH8-EXT	--	8	5-3/4	2	EXT	328	282	288	208	283	339	
1/4 x 10	WSBH10-EXT	--	10	7-3/4	2	EXT	328	282	288	208	283	339	

1) EXT = Exterior Coat.

2) Shear and withdrawal loads for wood-to-wood connections assume a side member thickness of 1-1/2" for DF/SP and SPF allowable loads and 1-3/4" for LVL allowable loads.

3) Withdrawal loads are derived from the minimum of head pull through tests and withdrawal capacity of threaded portion in main member.

4) Load are for 100% duration of load, and may be increased for the other duration factors in accordance the NDS.

New products or updated product information are designated in **blue font**.

Packaging Table

Use	Size (in)	Retail Box Offering ¹		50-count Pack ¹		Mini Bulk Offering ¹	
		MiTek Stock No.	Box/Ctn Qty	MiTek Stock No.	Box/Ctn Qty	MiTek Stock No.	Box/Ctn Qty
Exterior for General Purpose wood-to-wood connections	1/4 x 2-1/2	WSBH25-EXTR25	10-pack/25-ea	WSBH25-EXTR50	5-box/50-ea	WSBH25-EXTMB	2-box/200-ea
	1/4 x 4	WSBH4-EXTR12	10-pack/12-ea	WSBH4-EXTR50	5-box/50-ea	WSBH4-EXTMB	200-ea
	1/4 x 6	WSBH6-EXTR12	10-pack/12-ea	WSBH6-EXTR50	5-box/50-ea	WSBH6-EXTMB	200-ea
	1/4 x 8	WSBH8-EXTR12	10-pack/12-ea	WSBH8-EXTR50	5-box/50-ea	WSBH8-EXTMB	200-ea
	1/4 x 10	WSBH10-EXTR12	10-pack/12-ea	WSBH10-EXTR50	5-box/50-ea	WSBH10-EXTMB	200-ea

1) T30* drive is included in packaging.

* T30 is a trademark of Acument

The LumberLok Exterior Structural Connector Screw is a self-drilling screw that can be used with a number of MiTek connectors and also for wood-to-wood applications. The screws feature a T20* drive head with integral washer and gimlet point for ease of installation. The twin-lead threads drive in twice as fast as the single lead threads significantly reducing installation time. The MiTek head stamp identifies the screw length for easy inspection.

Screw shear capacities are based on a diameter of 0.162" when the shear plane is on the screw shank (SH) and 0.109" when the shear plane is on the threads (T). MiTek LumberLok Exterior Structural Connector Screws have a bending yield strength of 170,000 psi.

Materials: Low carbon hardened steel.

Finish: Gold Coat

Codes: IBC, FL, LA

Installation:

- Screws are self-drilling.
- Install using a low speed clutch drill with T20* drive (not included). The washer head should be flat to the surface. Do not over-tighten the screws.
- Installing the screw at an angle may introduce additional bending and tension forces into the fastener if the screw head is not flat to the bearing surface. Care should be given to ensure the fastener is installed perpendicular to the plane of the fastener hole.
- **Impact drills are not recommended for use with LumberLok Screws**
- Reference list of MiTek connectors compatible with LumberLok screws on page 37.

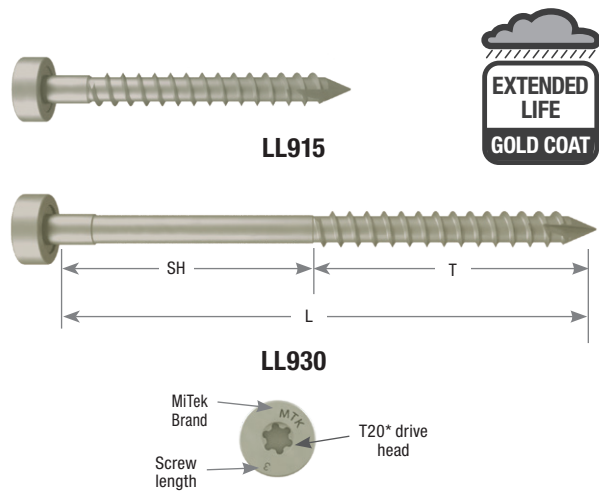

Specification Table

Size	MiTek Stock No.	Ref. No.	Dimensions (in)				DF/SP Allowable (Lbs.) ^{2,5}					S-P-F Allowable (Lbs.) ^{2,5}					Code Ref.
			L	SH	T	Finish ¹	Shear Capacity			Withdrawal Capacity ³	Shear Capacity			Withdrawal Capacity ³			
							Wood-to-Wood ⁴	Steel-to-Wood			Wood-to-Wood ⁴	Steel-to-Wood					
							18 Ga	16 Ga			18 Ga	16 Ga					
#9 x 1-3/8	LL915-GC	SD9112	1-3/8	1/4	1-1/8	GC	--	105	130	120	--	105	105	110	IBC, FL, LA		
#9 x 2-7/8	LL930-GC	SD9212	2-7/8	1-3/8	1-1/2	GC	105	165	165	150	100	140	140	150			

- 1) GC = Gold Coat over Clear Zinc Trivalent.
- 2) Allowable shear loads assume a side plate tensile strength of 45 ksi.
- 3) Withdrawal loads are for steel-to-wood connections and assume a side plate thickness of 1/4" or less.
- 4) Shear loads for wood-to-wood connections assume a side member thickness of 1-1/2".
- 5) Loads are for 100% duration of load factors and may be increased for other duration factors in accordance with the NDS.

Packaging Table

Use	Size (in)	Retail Box Offering	
		MiTek Stock No.	Box/Ctn Qty
Exterior for Deck & other wood-to-wood connections	#9 x 1-3/8"	LL915-GCR50	50-pack/20-ea
	#9 x 2-7/8"	LL930-GCR50	50-pack/20-ea

* T20 is a trademark of Acument

Continued on next page

Common Deck Connectors that are Compatible with LumberLok Structural Connector Screws

This is not a complete list of MiTek connectors that are compatible with LumberLok Structural Connector Screws. Most connectors that are installed with nails can also be installed with LumberLok Structural Connector Screws. For the connectors shown below, the catalog allowable design values will not change when installed with MiTek's LumberLok Structural Connector Screws shown.



LL915



LL930



Fasteners

MiTek Stock No.	LumberLok Screw		MiTek Stock No.	LumberLok Screw		MiTek Stock No.	LumberLok Screw	
	LL915 Qty	LL930 Qty		LL915 Qty	LL930 Qty		LL915 Qty	LL930 Qty
Angles / Framing Plates			Hangers			Column / Post Bases		
AC5-TZ	--	6	JUS28-TZ	--	10	PA44E-TZ	--	6
AC7-GC	--	8	JUS28-2TZ	--	10	PA44-TZ	--	8
AC7-TZ	--	8	JUS28-3TZ	--	10	PAU44-TZ	--	12
AC9-TZ	--	10	JUS210-GC	--	12	PA46E-GC	--	8
MPA1-GC	12	--	JUS210-TZ	--	12	PA46E-TZ	--	8
MPA1-TZ	12	--	JUS210-2GC	--	14	PA46-TZ	--	14
MP34-TZ	8	--	JUS210-2TZ	--	14	PAU46-TZ	--	12
MP4F-TZ	12	--	JUS210-3TZ	--	14	PA66E-GC	--	8
MP3-TZ	--	6	JUS44-TZ	--	6	PA66E-TZ	--	8
MP5-TZ	--	8	JUS46-TZ	--	8	PA66-TZ	--	16
MP7-TZ	--	10	JUS48-TZ	--	10	PAU66-TZ	--	12
MP9-TZ	--	12	JUS410-TZ	--	14	PAU88-TZ	--	14
SDPT5-TZ	5	--	SKH26L/R-TZ	6	6	Hurricane Ties		
SDPT7-TZ	5	--	SKH28L/R-TZ	8	10	RT3A-TZ	8	--
Hangers			SKH210L/R-GC	10	14	RT4-TZ	8	--
ADTT-TZ	10	--	SKH210L/R-TZ	10	14	RT5-TZ	8	--
CSH-TZ	10	--	SKH210L/R-2TZ	--	24	RT7-TZ	10	--
JUS24-GC	--	6	Column / Post Caps			RT7A-GC	10	--
JUS24-TZ	--	6	PB44-6GC	--	16	RT7A-TZ	10	--
JUS24-2TZ	--	6	PB44-6TZ	--	16	RT8A-TZ	10	--
JUS26-GC	--	8	PB66-6GC	--	16	RT15-GC	10	--
JUS26-TZ	--	8	PB66-6TZ	--	16	RT15-TZ	10	--
JUS26-2GC	--	8	PBES44-TZ	--	16	RT16A-TZ	9	8
JUS26-2TZ	--	8	PBES66-TZ	--	16	RT16-2TZ	16	--
JUS28-GC	--	10	PA44E-GC	--	6			

Copyright © 2022 MiTek Industries, Inc. All Rights Reserved

For customer convenience, we offer a wide range of bolts specified for the MiTek product line. Each bolt is shipped with two washers and one hex nut.

Materials: Bolts and nuts are standard hex head conforming to ASTM A 307 Grade A or SAE Grade 2 or better. Washers conform to American National Standard Type A plain steel, ANSI B.22.1.

Finish: Zinc plated

Installation:

- For installation into connectors in general, install with both washers unless otherwise directing in this catalog.

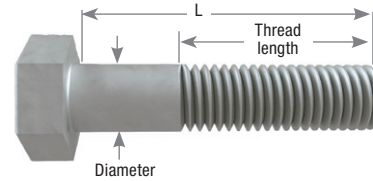

Bolt Specification Table

MiTek Stock No.	Description	Thread Length (in)
	Dia. x L (in)	
B384	3/8 x 4	1
B125	1/2 x 5	1-1/4
B126	1/2 x 6	1-1/4
B127	1/2 x 7	1-1/2
B128	1/2 x 8	1-1/2
B583	5/8 x 3	1-1/2
B584	5/8 x 4	1-1/2
B585	5/8 x 5	1-1/2
B586	5/8 x 6	1-1/2
B587	5/8 x 7	1-3/4
B588	5/8 x 8	1-3/4
B589	5/8 x 9	1-3/4
B5810	5/8 x 10	1-3/4
B343	3/4 x 3	1-3/4
B344	3/4 x 4	1-3/4
B345	3/4 x 5	1-3/4
B346	3/4 x 6	1-3/4
B347	3/4 x 7	2
B348	3/4 x 8	2
B349	3/4 x 9	2
B3410	3/4 x 10	2
B3411	3/4 x 11	2
B785	7/8 x 5	2
B786	7/8 x 6	2
B787	7/8 x 7	2-1/4
B788	7/8 x 8	2-1/4
B7810	7/8 x 10	2-1/4
B103	1 x 3	2-1/4
B104	1 x 4	2-1/4
B105	1 x 5	2-1/4
B106	1 x 6	2-1/4
B107	1 x 7	2-1/2
B108	1 x 8	2-1/2

Metric Conversion

Bolt Diameter Conversion	
Inches	Millimeters
3/8	9.50
1/2	12.70
5/8	15.90
3/4	19.10
7/8	22.20
1	25.40
1-1/8	28.58
1-1/4	31.75



Round Holes:
Always fill all (normal-size) round nail holes, unless otherwise noted.



Diamond Holes:
Optional nailing for maximum listed capacity or for temporary hanger fastening during installation.

When there are **MIN** and **MAX** values:
MIN: fill all round nail holes
MAX: fill all round and diamond holes



Large Round Holes:
For concrete/masonry installation; no need to be filled when connected to wood. Large round holes may be used for manufacturing which do not require a fastener. Verify fastener schedule in catalog.

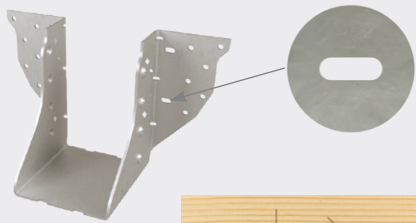

Obround Holes:
For ease of nailing at a tight location; always fill.

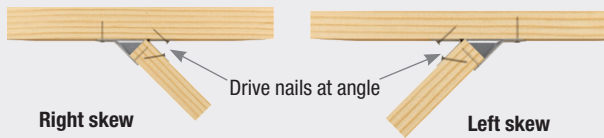

Right skew

Drive nails at angle

Left skew



Dimple Holes:
Guide double shear nails into the joist and header at a 30° to 45° angle

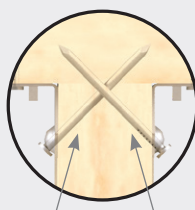

Use specified standard length common nails.
16d common and 10d common nails are 3-1/2" and 3" long respectively.

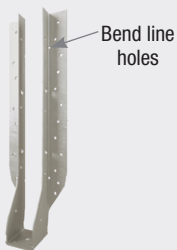

Bend line holes

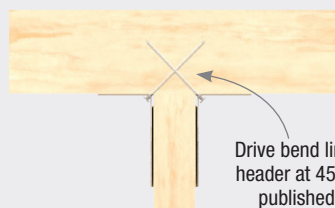

Drive bend line nails into header at 45° to achieve published strength

Typical I-Joist Nailing

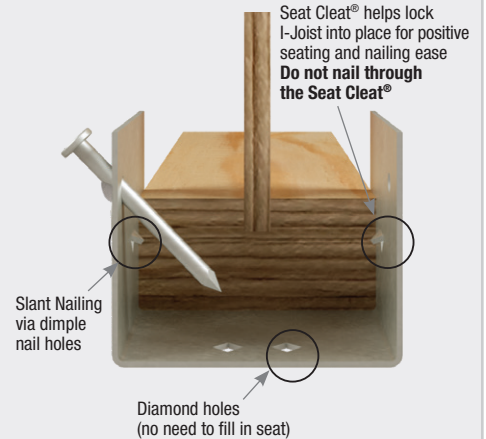

Common Nailing Errors



Wrong Angle

When a nail is driven into the bottom flange of the wood I-Joist parallel to the glue lines, separation of veneers can occur which substantially reduces the design loads of the connection.



Nail Too Long

When using nails longer than MiTek's recommended nails, bottom flange splitting may occur. Also, this can raise the wood I-Joist off the seat, resulting in uneven surfaces and squeaky floors along with reduced design load.

CONCRETE & MASONRY



CONCRETE & MASONRY

42-63

Anchor Bolts	49-51
Anchor Rod Chairs	48
Anchoring Epoxy	42-43
Beam Seats	62
Bearing Plates	51
Concrete Form Ties & Wedge	54
Coupler Nuts	53
Foundation Anchors	55-61
Hangers	63
Hex Nuts	54
Mechanical Anchors	44-46
Retro Plates	61
Threaded Rods	47, 52
Washers	53

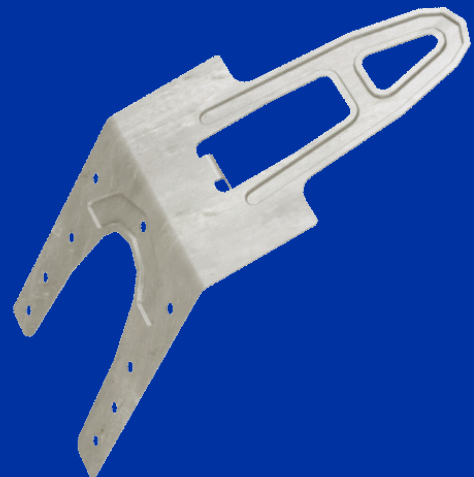

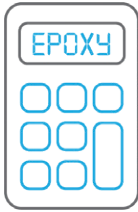

EPOXY QUANTITY ESTIMATOR

Estimate how much epoxy your job needs. Quickly calculate the number of required cartridges using the Epoxy Quantity Estimator. Run our web application on your desktop, smart phone or tablet. The Estimator works with threaded rods or rebar. Enter the quantity, rod diameter and drilled hole depth, choose the epoxy type and the required number of cartridges is displayed. Mitek.ca/products/Builder-Products/Anchoring-Epoxy/.

CIA-GEL 7000-C Epoxy

CIA-GEL 7000-C Epoxy is an adhesive designed to attach anchor rods into concrete that is, or may become, cracked due to cyclic loading from wind or earthquakes. It is a low odor, solvent free, non-shrink, non-sag adhesive. The two-component (resin and hardener) epoxy is supplied in equal volume cartridges, which are combined in a 1:1 ratio when dispensed through the attached mixing nozzle. Either a manual or powered dispenser may be used. The cartridges are sealed with a D-plug which opens easily and allows partially used cartridges to be saved for later use. The epoxy has a two year shelf life when stored in unopened containers at temperatures between 50°F and 77°F.

Applications:

- Anchors threaded rod or deformed rebar into cracked or uncracked concrete.
- Anchoring All Thread Rod for holdowns into concrete for high seismic zones (ASCE Seismic Design C-F)
- Horizontal and overhead anchoring applications (requires special inspection)

Codes: IBC, LA, NSF/ANSI Standard 61



Available Sizes:
 8.5 oz. – GEL7C-10
 20.3 oz. – GEL7C-22



MiTek Adhesive Anchor Design is powerful design software for CIA-GEL 7000-C that provides optimized epoxy connection solutions for threaded anchors post-installed into concrete. The software determines the required anchor rod steel grade, diameter and effective embedment depth based on applied factored tension, shear and moment loads. Get the free download at Mitek.ca/software/Adhesive-Anchor-Design/.

CIA-EA Epoxy Acrylate

CIA-EA Adhesive Anchoring System is an epoxy acrylate specifically designed to be a high strength, fast cure structural adhesive for anchoring threaded rod and deformed rebar into uncracked concrete. It has the added advantage of being formulated to be used in colder temperatures (32°F) while maintaining excellent flowability. CIA-EA may also be used with fully grouted CMU and reinforced brick construction. It is a 2-component, 100% solids, moisture insensitive adhesive that is ideally suited for a wide range of applications. It is composed of a proprietary blend of solvent free epoxy acrylate resin and is backed by independent research and testing. The epoxy has a 15 month shelf life when stored in unopened containers at temperatures between 41°F to 77°F.

Applications:

- Anchors All-Thread rod into concrete
- May also be used to anchor rebar, starter bars and dowels
- Applications requiring fast cure times
- Cold weather applications
- Can be used in horizontal anchoring applications
- Can be used in overhead anchoring applications (requires special inspection)

Codes: IBC, NSF/ANSI Standard 61



Available Sizes:
9.4 oz. – EA-10

DUCs are mechanical anchors expanded into holes that have been undercut at the bottom using an undercutting drill bit. This creates a true bearing type anchor that performs like a cast-in-place headed anchor. Load is transferred into the concrete through bearing, not friction like traditional expansion anchors. Excellent performance in seismic and dynamic loading conditions. Meets ACI 318-14 Chapter 17 (2018 IBC) requirements as a code anchor, including seismic loading, tension zone, and cracked concrete provisions.

Rod Materials: ASTM A36 (L Series), A193 Grade B7 (H Series), or AISI 316 Stainless Studs

Anchor Body Materials: ASTM A 513 Type 5, or AISI 316 Stainless

Codes: IBC, FL, LA

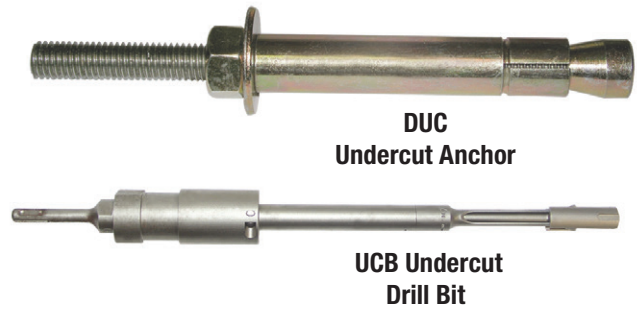

Tension and shear capacities for DUC Anchors in $f'_c \geq 2,500$ psi concrete

MiTek Stock No.	Rod Dia. d_b (in)	Anchor Length l_b (in)	Expansion Coupling Dia. d_c (in)	Drilled Hole Depth of Stop Bit (in)	Effective Embedment h_{ef} (in)	Allowable Tensile Capacity (Lbs.)	Allowable Shear Capacity (Lbs.)	Code Ref.
DUC38-275L	3/8	5-1/2	5/8	3-1/8	2-3/4	2280	2245	IBC, FL, LA
DUC38-275LT		6-3/4		4-3/8	4	4910	4855	
DUC38-400H								
DUC38-400HT								
DUC12-400L	1/2	7	3/4	4-1/4	4	4170	4110	
DUC12-400LT		8		5-1/4	5	7365	8855	
DUC12-500H								
DUC12-500HT								
DUC12-675H	9-3/4	7	6-3/4	8990	8990	8990	8990	
DUC12-675HT								
DUC58-450L	5/8	7-3/4	1	5	4-1/2	6290	6560	
DUC58-450LT		10-3/4		8	7-1/2	13530	14110	
DUC58-750H								
DUC58-750HT								
DUC58-900H		12-1/4		9-1/2	9	14315		
DUC58-900HT								
DUC34-500L	3/4	8-5/8	1-1/8	5-7/8	5	7365	9685	
DUC34-500LT		13-5/8		10-7/8	10	20830	20875	
DUC34-1000H								
DUC34-1000HT								

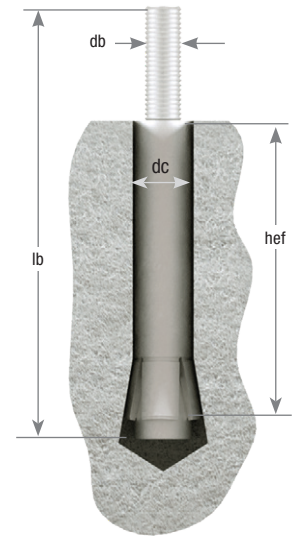

- 1) Allowable tensile and shear capacities are for anchors installed at standard edge distance and spacing in uncracked concrete in accordance with the 2018 IBC and referenced ACI documents.
- 2) See ICC-ES ESR-1970 for additional information.

Screw-Bolt+ anchors are a one-piece, heavy duty screw anchor with a finished hex head. The patented thread design, designed for use with standard ANSI drill bits, reduces installation torque and enhances productivity. The steel threads along the anchor body tap into the hole during installation to provide keyed engagement and allow for reduced edge and spacing distances.



Diameter and length identification mark



Screw-Bolt™+
(zinc plated)

Finish: Zinc Plated or Mechanically Galvanized

Codes: IBC, FL, LA

Zinc Plated		Mechanically Galvanized		Anchor Size (in) ¹	Hole Size (in)	Socket Size (in)	Code Ref.
MiTek Stock No.	Ref. No.	MiTek Stock No.	Ref. No.				
PFM1411000	THDB25178H	--	--	1/4 x 1-1/4	1/4	7/16	IBC, FL, LA
PFM1411020	THD25134H	--	--	1/4 x 1-3/4			
PFM1411060	THD25214H	--	--	1/4 x 2-1/4			
PFM1411100	THDB25300H	--	--	1/4 x 3	3/8	9/16	
PFM1411160	THD37134H	--	--	3/8 x 1-3/4			
PFM1411220	THD37212H	--	--	3/8 x 2-1/2			
PFM1411240	THD37300H	--	--	3/8 x 3			
PFM1411280	THD37400H	PFM1461280	THD37400HMG	3/8 x 4			
PFM1411300	THD37500H	PFM1461300	THD37500HMG	3/8 x 5	1/2	3/4	
PFM1411320	THD37600H	PFM1461320	THD37600HMG	3/8 x 6			
PFM1411340	--	--	--	1/2 x 2			
PFM1411360	--	--	--	1/2 x 2-1/2	5/8	15/16	
PFM1411380	THD50300H	--	--	1/2 x 3			
PFM1411420	THD50400H	PFM1461420	THD50400HMG	1/2 x 4			
PFM1411460	THD50500H	PFM1461460	THD50500HMG	1/2 x 5			
PFM1411480	THD50600H	PFM1461480	THD50600HMG	1/2 x 6			
PFM1411520	THD50800H	PFM1461520	THD50800HMG	1/2 x 8	3/4	1-1/8	
PFM1411540	--	--	--	5/8 x 3			
PFM1411580	THD62400H	--	--	5/8 x 4			
PFM1411600	THD62500H	PFM1461600	THD62500HMG	5/8 x 5			
PFM1411640	THD62600H	PFM1461640	THD62600HMG	5/8 x 6	3/4	1-1/8	
PFM1411680	THD62800H	PFM1461680	THD62800HMG	5/8 x 8			
PFM1411700	--	--	--	3/4 x 3			
PFM1411720	THD75400H	--	--	3/4 x 4	3/4	1-1/8	
PFM1411760	THD75500H	--	--	3/4 x 5			
PFM1411800	THD75600H	PFM1461800	THD75600HMG	3/4 x 6			
PFM1411840	THD75812H	--	--	3/4 x 8			
--	--	PFM1461850	THD75812HMG	3/4 x 8-1/2			
PFM1411880	THD75100H	--	--	3/4 x 10			

1) The anchor size includes the diameter and length of the anchor measured from under the head.

Power-Stud® HD5 Wedge Expansion Anchors

The Power-Stud® HD5 anchor is a fully threaded, torque-controlled, wedge expansion anchor. Suitable base materials include normal-weight concrete, sand-lightweight concrete and grouted concrete masonry. Nut and washer are included.

Materials: Anchor Body – Carbon Steel;
Expansion Clip: Type 304 Stainless Steel;
Hex Nut: ASTM A 563, Grade A; Washer: ASTM F 844

Finish: Anchor Body, Nut, Washer – Hot-dip galvanized;
Expansion Clip: Stainless Steel



Power-Stud® HD5

MiTek Stock No. ²	Ref. No.	Anchor Size (in) ¹	Thread Length (in)	Code Ref.
7716HD5	WA37500MG	3/8 x 5	3-1/2	--
7720HD5	WA50234MG	1/2 x 2-3/4	1	
7723HD5	WA50414MG	1/2 x 4-1/2	2-3/4	
7724HD5	WA50512MG	1/2 x 5-1/2	3-3/4	
7726HD5	WA50700MG	1/2 x 7	5-1/4	
7733HD5	WA62500MG	5/8 x 5	3	
7734HD5	WA62600MG	5/8 x 6	4	
7738HD5	WA62812MG	5/8 x 8-1/2	6-1/2	
7748HD5	WA75812MG	3/4 x 8-1/2	6	

- 1) The anchor size includes the diameter and the overall length of the anchor.
- 2) All anchors are packaged with nuts and washers.

Power-Stud+® SD1 Wedge Expansion Anchors

Power-Stud+® SD1 anchor is a fully threaded, torque-controlled, wedge expansion anchor which is designed for consistent performance in cracked and uncracked concrete. Suitable base materials include normal-weight concrete, sand-lightweight concrete, concrete over steel deck and grouted concrete masonry. Nut and washer are included.

Materials: Anchor Body, Expansion Clip – Carbon Steel;
Hex Nut: ASTM A 563, Grade A; Washer: ASTM F 844

Finish: Zinc Plated

Codes: IBC, FL, LA



Power-Stud+®
SD1 anchor

MiTek Stock No. ²	Ref. No.	Anchor Size (in) ¹	Thread Length (in)	Code Ref.
7413SD1	WA37300	3/8 x 3	1-5/8	IBC, FL, LA
7416SD1	WA37500	3/8 x 5	3-5/8	
7424SD1	WA50512	1/2 x 5-1/2	3-3/4	
7426SD1	WA50700	1/2 x 7	5-1/4	
7427SD1	WA50812	1/2 x 8-1/2	6-3/4	
7433SD1	WA62500	5/8 x 5	3	
7434SD1	WA62600	5/8 x 6	4	
7436SD1	WA62700	5/8 x 7	5	
7438SD1	WA62812	5/8 x 8-1/2	6-1/2	
7439SD1	WA62100	5/8 x 10	8	
7442SD1	WA75512	3/4 x 5-1/2	3	

- 1) The anchor size includes the diameter and the overall length of the anchor.
- 2) All anchors are packaged with nuts and washers.

THR Threaded Rods

Concrete & Masonry

THR's support the deck oriented code requirements for mechanically reinforced railing post and deck to house ledger board attachments.

Materials: ASTM A36 steel, also conforms to ASTM F1554, Grade 36

Finish: Hot-dip galvanized

Installation:

- Install into wet concrete with nut embedded or drill minimum 1/16" – 1/8" oversized hole depending on rod size and secure with anchor epoxy. Nut and washer included.



Typical THR installation

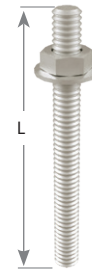

THR

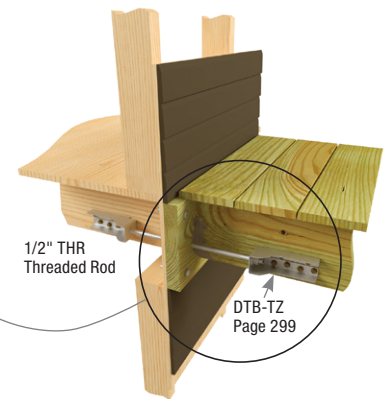
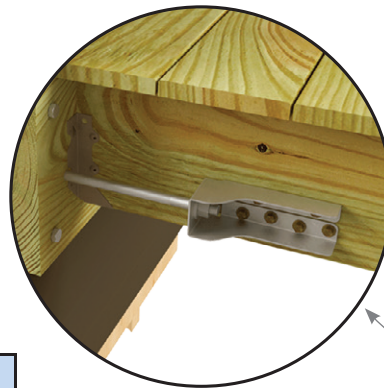

Typical THR deck to ledger installation

MiTek Stock No.	Ref. No.	Bolt Dia.	L (in)	Corrosion Finish	Code Ref.
THR125-HDG	RFB#4X5HDG	1/2	5	HDG	
THR126-HDG	RFB#4X6HDG	1/2	6	HDG	
THR128-HDG	RFB#4X8HDG	1/2	8	HDG	
THR1218-HDG	--	1/2	18	HDG	
THR1224-HDG	--	1/2	24	HDG	--
THR1236-HDG	--	1/2	36	HDG	
THR588-HDG	RFB#5X8HDG	5/8	8	HDG	
THR5812-HDG	RFB#5X12HDG	5/8	12	HDG	
THR5816-HDG	RFB#5X16HDG	5/8	16	HDG	

Corrosion Finish Key ■ Stainless Steel ■ Gold Coat ■ HDG ■ Triple Zinc

When attached to the forms, the ARC allows for easy and precise placement of anchor rods prior to pouring concrete. The “chair” and nut are pre-assembled for quick installation.

Features:

- Positive stop for threaded rod at the bottom of the nut
- Easy flow of concrete
- Nibbled out corners allows for potentially tighter positioning on inside corner of form
- 1" stand-off base to meet code requirement for concrete cover

Materials: Nut: Heavy Hex; Chair: 16 gauge

Finish: Nut: None; Chair: Rolled Steel

Installation:

- Installs with nails or screws. Threaded rod can then be screwed in to desired depth.

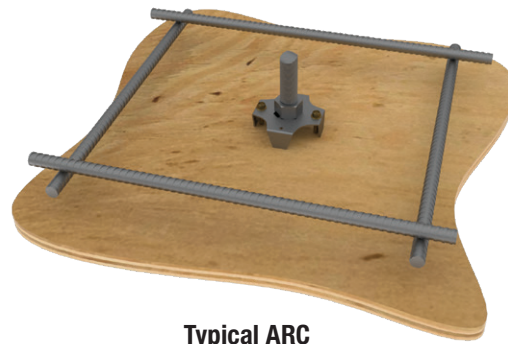

Typical ARC installation

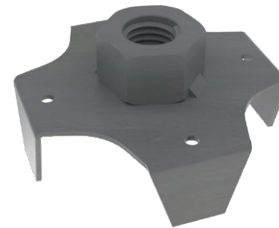

ARC6

MiTek Stock No.	Ref. No.	Dia. (in)	Code Ref.
ARC4	ABL4-1	1/2	--
ARC5	ABL5-1	5/8	
ARC6	ABL6-1	3/4	
ARC7	ABL7-1	7/8	
ARC8	ABL8-1	1	
ARC9	ABL9-1	1-1/8	
ARC10	ABL10-1	1-1/4	
ARC11	--	1-3/8	
ARC12	--	1-1/2	
ARC14	--	1-3/4	
ARC16	--	2	

Embossed ends provide guides for embedment angle and depth. An embedment line is embossed on the shaft for easy installation. Features rolled threads for high tensile strength.

- STB** – For monolithic slabs and concrete stem walls
- STBL** – Designed for use with 3x sill plates
Excellent choice for use with taller holddown washers like those in the PHD series

Materials: ASTM A 36 steel, also conforms to ASTM F1554 and ASTM A 307 Grade A requirements for bolts
Finish: None
Options: See Chart for Corrosion Finish Options
Codes: IBC, FL, LA

Installation:

- Select appropriate STB or STBL Anchor Bolt.
- Use normal weight concrete with minimum compressive strength of 2,500 psi.
- Minimum center-to-center spacing between bolts is 3(E) for anchors acting simultaneously in tension.
- Match embedment depth with embedment line on the STB or STBL shaft.
- The STB or STBL does not need to be tied to the rebar.
- Nuts and washers are not included.

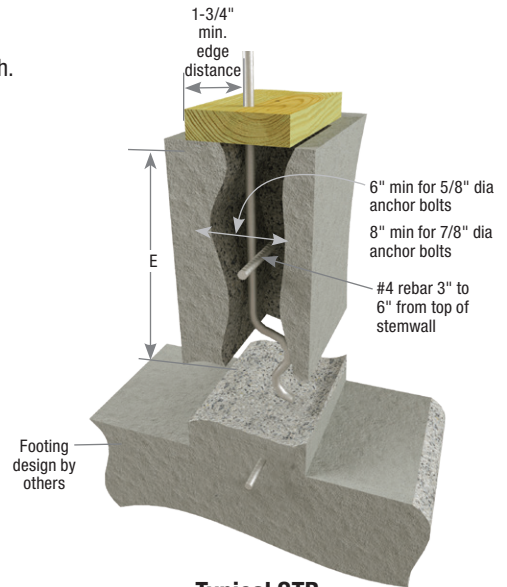

Typical STB anchor bolt installation

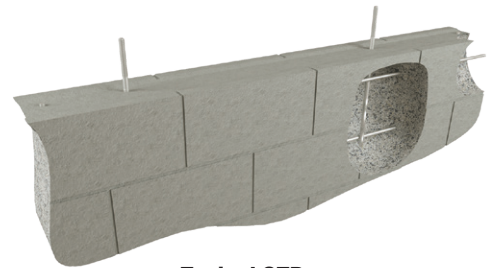

Typical STB concrete block installation

Anchor Bolt Selection Table

MiTek Stock No.	2x, 3x, (2) 2x Sill Plates ¹
	Mono Pour
PHD2A	STB16 STBL16
TDX2-TZ	
LTS20B	
HTT16	
HTT45	
PHD4A	STB20 STBL20
HTT45	
TD5	
HTT45	STB24 STBL24
PHD5A	
PHD8	STB28 STBL28
UPHD8	
TD7	
TD9	
TD12	

* Recommend installation of washer under nut of anchor bolt.
 1) STBL model are recommended for use with PHD and UPHD8 holdowns on (2) 2x and 3x sill plates.

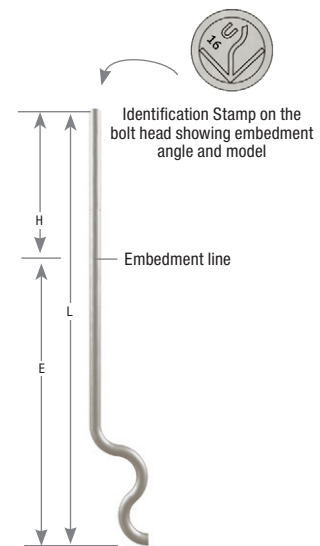

STB/STBL

Continued on next page

Monolithic or Stem Wall Foundations – Prior to pour, install the STB or STBL in an upright position and at a 45° angle to the wall. Install one horizontal #4 rebar at a depth of 4" (minimum). (See illustrations.)

Concrete Block Applications – Prior to cell pour, install the STB or STBL in an upright position and at a 45° angle to the wall. (See illustrations.) Use the embossed angle guide on the end of the STB or STBL shaft as a guide. Install one horizontal #4 rebar at a depth of 4" and one vertical #4 rebar maximum 48" o.c. spacing. Fill all cells with concrete having a minimum 2,500 psi compressive strength.

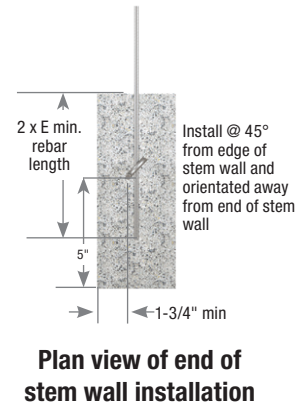
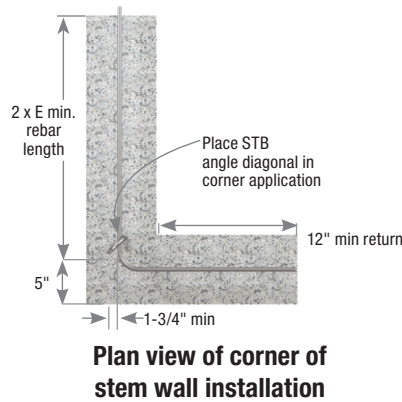
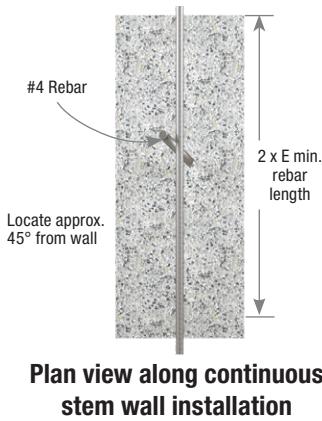
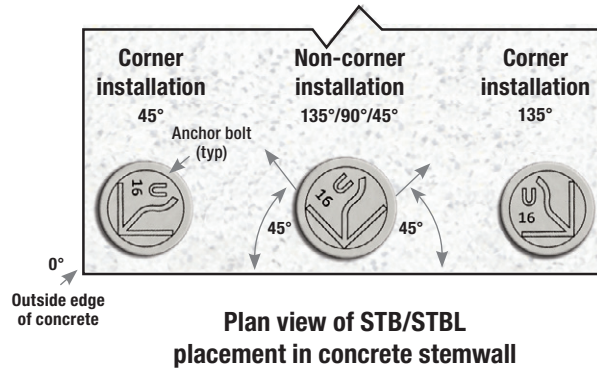

MiTek Stock No.	Ref. No.	Dimensions (in)					Allowable Tension Loads (Lbs) ^{1,2}									Corrosion Finish	Code Ref.
		Stem-wall Width	Dia.	L	H	Min. Embed (E)	ASCE Seismic Design Category A&B			Wind			ASCE Seismic Design Category C - F				
							Midwall	Corner	End Wall	Midwall	Corner	End Wall	Midwall	Corner	End Wall		
STB16	SSTB16	6	5/8	17-13/16	5	12-13/16	4230	4230	4230	4230	4230	4230	3525	3525	3525	IBC, FL, LA	
STB20	SSTB20	6	5/8	21-13/16	5	16-13/16	5120	4740	4740	5115	4230	4230	4265	3555	3555		
STB24	SSTB24	6	5/8	25-13/16	5	20-13/16	5990	5915	5915	5990	5570	5570	4990	4675	4675		
STB28	SSTB28	8	7/8	31	5	26	10100	9490	9490	9110	9110	9110	7650	7650	7650		
STB34	SSTB34	8	7/8	36	6	30	11415	10525	10250	11390	10525	9405	9515	8770	7900		
STB36	SSTB36	8	7/8	38	8	30	11415	10525	10250	11390	10525	9405	9515	8770	7900		
STBL16	SSTB16L	6	5/8	19-9/16	6-3/4	12-13/16	4230	4230	4230	4230	4230	4230	3525	3525	3525		
STBL20	SSTB20L	6	5/8	23-9/16	6-3/4	16-13/16	5120	4740	4740	5115	4230	4230	4265	3555	3555		
STBL24	SSTB24L	6	5/8	27-9/16	6-3/4	20-13/16	5990	5915	5915	5990	5570	5570	4990	4675	4675		
STBL28	SSTB28L	8	7/8	32-3/4	6-3/4	26	10100	9490	9490	9110	9110	9110	7650	7650	7650		

- 1) Loads may not be increased for short term loading.
- 2) Minimum center to center spacing between bolts is 3(E) for anchors acting in tension simultaneously.
- 3) Minimum edge distance is 1-3/4".
- 4) Concrete stemwall shall be a minimum of 6" thick for 5/8" anchor bolts and 8" for 7/8" anchor bolts.
- 5) End distance shall be no less than 5".
- 6) Connection is limited by lowest of bolt or holdown capacity.
- 7) Concrete block shall be minimum 10" block.
- 8) See ICC-ES ESR-2266 for additional information.

Corrosion Finish Key

■	Stainless Steel
■	Gold Coat
■	HDG
■	Triple Zinc

Copyright © 2022 MiTek Industries, Inc. All Rights Reserved

AB Anchor Bolts

Concrete & Masonry

The AB anchor bolt provides an economical way to meet the prescriptive requirements of the 2018 IRC for securing mudsill plates to a concrete or masonry foundation. The bolt is manufactured from ASTM 1554 steel and has a hot-dip galvanized finish. A nut (ASTM A 563) and washer (ASTM F 844) are included. In some jurisdictions, a plate washer may be required. Check with your local Building Official.

Materials: Bolt: ASTM F 1554, Nut: ASTM A 563, Washers: ASTM F 844

Finish: Hot-dip galvanized

Codes: See IRC R403.1.6, IBC 2308.3.1, 2308.3.1.1, 2308.3.1.2 for minimum diameter and embedment into masonry or concrete.

Installation:

- Select appropriate AB Anchor Bolt.
- Use concrete with minimum compressive strength of 2,500 psi at 28 days.
- Nuts and washers are included.
- Anchor bolts intended for use to satisfy code prescribed anchoring of mudsill plates, and shall be installed as defined in the code.
- Allowable loads shall be derived in accordance with the code.
- Plate washers may be required in some jurisdictions.

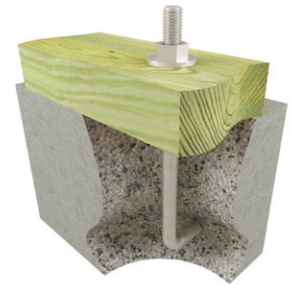

Typical AB128-HDG installation

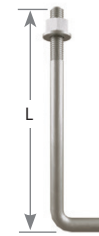

AB128-HDG

MiTek Stock No.	Ref. No.	Bolt Dia.	L (in)	Corrosion Finish	Code Ref.
AB126-HDG	--	1/2	6		PC
AB128-HDG	--	1/2	8		
AB1212-HDG	--	1/2	12		
AB5812-HDG	--	5/8	12		

Corrosion Finish Key
■ Stainless Steel
■ Gold Coat
■ HDG
■ Triple Zinc

BP / HBPS / LBP / LBPS Bearing Plates

BP / LBP – Designed to meet code requirements for mudsill-to-foundation

HBPS / LBPS – Offers anchor bolt adjustment slots

Materials: See chart

Finish: BP / HBPS – none; LBP / LBPS – G-185 galvanizing

Options: See Chart for Corrosion Finish Options

Codes: See IRC R602.11.1, IBC 2308.3.1.1 for minimum plate size requirements

Installation:

- Bolt holes are sized 1/16" larger than Bolt Dia. shown in chart.

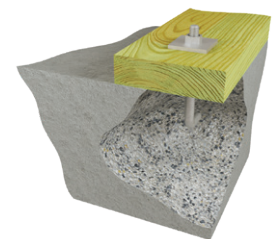

Typical Bearing Plate installation

MiTek Stock No.	Ref. No.	Plate Thickness (T)		Dimensions (in)		Bolt Dia.	Corrosion Finish	Code Ref.
				W	L			
LBP12-TZ	LBP1/2, LBP1/2Z	10 Ga	9/64	2	2	1/2		--
LBP58-TZ	LBP5/8, LBP5/8Z	10 Ga	9/64	2	2	5/8		PC
LBPS12-TZ	LBPS1/2, LBPS1/2Z	10 Ga	9/64	3	3	1/2		--
LBPS58-TZ	LBPS5/8, LBPS5/8Z	10 Ga	9/64	3	3	5/8		--
HBPS12	BPS1/2-3	3 Ga	1/4	3	3	1/2		PC
HBPS34	BPS3/4-3	3 Ga	1/4	3	3	3/4		
HBPS58	BPS5/8-3	3 Ga	1/4	3	3	5/8		
HBPS12-412	BPS1/2-6	3 Ga	1/4	3	4-1/2	1/2		
HBPS58-412	BPS5/8-6	3 Ga	1/4	3	4-1/2	3/4		
HBPS34-412	BPS3/4-6	3 Ga	1/4	3	4-1/2	5/8		
BP12	BP1/2	7 Ga	3/16	2	2	1/2		
BP582	BP5/8-2	7 Ga	3/16	2	2	5/8		
BP583	BP5/8, BP5/8-3	3 Ga	1/4	3	3	5/8		
BP343	BP3/4-3	3 Ga	1/4	3	3	3/4		

Corrosion Finish Key
■ Stainless Steel
■ Gold Coat
■ HDG
■ Triple Zinc

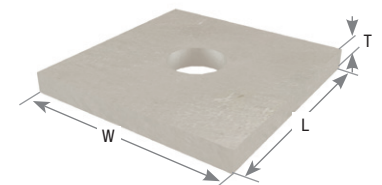

BP / LBP Standard Bearing Plate

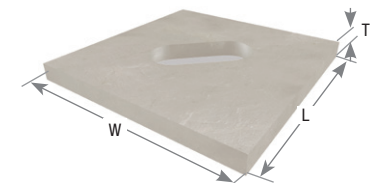

HBPS / LBPS Slotted Bearing Plate

New products or updated product information are designated in **blue font**.

ATR All Thread Rod is a continuously threaded low carbon steel rod that may be used for anchoring MiTek's holdowns, tension ties and wood structural panel shear walls to concrete. They can also be used for many other general purpose tension transfer fastening needs.

Materials: ASTM A307 Grade A

Finish: None or Zinc Plated (See Chart)

Installation:

- ATR All Thread Rod can be cast-in-place or epoxied into concrete. Use MiTek's CIA-EA epoxy acrylate or CIA-GEL 7000-C epoxy when installed as a post installed application and follow the published installation instructions to obtain maximum strength. Use MiTek's CIA-GEL 7000 when installing into fully grouted CMU block wall. Reference MiTek's Adhesive Anchor Design Software for more information, MiTek-US.com.



Dia. x L (in)	Plain		Zinc Plated		Code Ref.
	MiTek Stock No.	Ref. No.	MiTek Stock No.	Ref. No.	
3/8 x 5	ATR385	--	ATR385-ZP	--	
3/8 x 8	ATR388	--	ATR388-ZP	--	
3/8 x 10	ATR3810	--	ATR3810-ZP	--	
3/8 x 12	ATR3812	ATR3/8X12	ATR3812-ZP	--	
3/8 x 16	ATR3816	--	ATR3816-ZP	--	
3/8 x 18	ATR3818	--	ATR3818-ZP	--	
3/8 x 24	ATR3824	ATR3/8X24	ATR3824-ZP	--	
3/8 x 36	ATR3836	ATR3/8X36	ATR3836-ZP	--	
3/8 x 48	ATR3848	ATR3/8X48	ATR3848-ZP	ATR3/8X48ZP	
3/8 x 72	ATR3872	ATR3/8X72	--	--	
1/2 x 5	ATR125	--	ATR125-ZP	--	
1/2 x 8	ATR128	--	ATR128-ZP	--	
1/2 x 10	ATR1210	--	ATR1210-ZP	--	
1/2 x 12	ATR1212	ATR1/2X12	ATR1212-ZP	--	
1/2 x 16	ATR1216	--	ATR1216-ZP	--	
1/2 x 18	ATR1218	ATR1/2X18	ATR1218-ZP	--	
1/2 x 24	ATR1224	ATR1/2X24	ATR1224-ZP	--	
1/2 x 36	ATR1236	ATR1/2X36	ATR1236-ZP	--	
1/2 x 48	ATR1248	ATR1/2X48	ATR1248-ZP	--	
1/2 x 72	ATR1272	ATR1/2X72	--	--	
5/8 x 5	ATR585	--	ATR585-ZP	--	
5/8 x 8	ATR588	ATR5/8X8	ATR588-ZP	ATR5/8X8ZP	
5/8 x 10	ATR5810	--	ATR5810-ZP	--	
5/8 x 12	ATR5812	ATR5/8X12	ATR5812-ZP	ATR5/8X12ZP	
5/8 x 16	ATR5816	--	ATR5816-ZP	--	
5/8 x 18	ATR5818	ATR5/8X18	ATR5818-ZP	ATR5/8X18ZP	
5/8 x 24	ATR5824	ATR5/8X24	ATR5824-ZP	ATR5/8X24ZP	
5/8 x 36	ATR5836	ATR5/8X36	ATR5836-ZP	ATR5/8X36ZP	
5/8 x 48	ATR5848	ATR5/8X48	ATR5848-ZP	ATR5/8X48ZP	
5/8 x 72	ATR5872	ATR5/8X72	--	--	
3/4 x 5	ATR345	--	ATR345-ZP	--	
3/4 x 8	ATR348	ATR3/4X8	ATR348-ZP	ATR3/4X8ZP	
3/4 x 10	ATR3410	--	ATR3410-ZP	--	
3/4 x 12	ATR3412	ATR3/4X12	ATR3412-ZP	ATR3/4X12ZP	
3/4 x 16	ATR3416	--	ATR3416-ZP	--	
3/4 x 18	ATR3418	ATR3/4X18	ATR3418-ZP	ATR3/4X18ZP	
3/4 x 24	ATR3424	ATR3/4X24	ATR3424-ZP	ATR3/4X24ZP	
3/4 x 36	ATR3436	ATR3/4X36	ATR3436-ZP	ATR3/4X36ZP	
3/4 x 48	ATR3448	ATR3/4X48	ATR3448-ZP	ATR3/4X48ZP	
3/4 x 72	ATR3472	ATR3/4X72	--	--	

Dia. x L (in)	Plain		Zinc Plated		Code Ref.
	MiTek Stock No.	Ref. No.	MiTek Stock No.	Ref. No.	
7/8 x 5	ATR785	--	ATR785-ZP	--	
7/8 x 8	ATR788	--	ATR788-ZP	--	
7/8 x 10	ATR7810	--	ATR7810-ZP	--	
7/8 x 12	ATR7812	ATR7/8X12	ATR7812-ZP	ATR7/8X12ZP	
7/8 x 16	ATR7816	--	ATR7816-ZP	--	
7/8 x 18	ATR7818	--	ATR7818-ZP	ATR7/8X18ZP	
7/8 x 24	ATR7824	ATR7/8X24	ATR7824-ZP	ATR7/8X24ZP	
7/8 x 36	ATR7836	ATR7/8X36	ATR7836-ZP	ATR7/8X36ZP	
7/8 x 48	ATR7848	ATR7/8X48	ATR7848-ZP	ATR7/8X48ZP	
7/8 x 72	ATR7872	ATR7/8X72	--	--	
1 x 5	ATR15	--	ATR15-ZP	--	
1 x 8	ATR18	--	ATR18-ZP	--	
1 x 10	ATR110	--	ATR110-ZP	--	
1 x 12	ATR112	ATR1X12	ATR112-ZP	ATR1/2X12ZP	
1 x 16	ATR116	--	ATR116-ZP	--	
1 x 18	ATR118	--	ATR118-ZP	--	
1 x 24	ATR124	ATR1X24	ATR124-ZP	ATR1/2X24ZP	--
1 x 36	ATR136	ATR1X36	ATR136-ZP	ATR1X36ZP	
1 x 48	ATR148	ATR1X48	ATR148-ZP	--	
1 x 72	ATR172	ATR1X72	--	--	
1-1/8 x 5	ATR1185	--	ATR1185-ZP	--	
1-1/8 x 8	ATR1188	--	ATR1188-ZP	--	
1-1/8 x 10	ATR11810	--	ATR11810-ZP	--	
1-1/8 x 12	ATR11812	--	ATR11812-ZP	--	
1-1/8 x 16	ATR11816	--	ATR11816-ZP	--	
1-1/8 x 18	ATR11818	--	ATR11818-ZP	--	
1-1/8 x 24	ATR11824	--	ATR11824-ZP	--	
1-1/8 x 36	ATR11836	--	ATR11836-ZP	--	
1-1/8 x 48	ATR11848	ATR1-1/8X48	ATR11848-ZP	--	
1-1/8 x 72	ATR11872	--	--	--	
1-3/8 x 18	ATR13818	--	--	--	
1-3/8 x 24	ATR13824	--	--	--	
1-3/8 x 36	ATR13836	--	--	--	

New products or updated product information are designated in blue font.

The MiTek CNW coupler nut is designed to join threaded rods to embedded anchor rods. They are also used in the Z4 Tie Down system to attach Z-Rods together (See Z4 Product Catalog). The coupler nut has an inspection hole with an internal positive stop that allows easy verification that the ends of both rods have been fully threaded. The CNW coupler is made from low carbon ASTM A563 Grade A steel (Proof Load = 90 ksi) which makes it applicable for many common ASTM steel threaded rods of equivalent or lower strength.

Materials: ASTM A563 Grade A

Finish: Zinc Plated

Installation:

- Inspection hole is provided to assure easy inspection.
- Tighten rods until they are visible in the inspection hole.
- Works with all thread rods of specified diameter except hot-dip galvanized.

MiTek Stock No.	Ref. No.	Dimensions (in)		Allowable Tension (Lbs.) 100%	Code Ref.
		Rod Diameter	H Min		
CNW38-ZP	CNW3/8	0.375	1-1/8	2400	--
CNW12-ZP	CNW1/2	0.500	1-1/4	4265	
CNW58-ZP	CNW5/8	0.625	2-1/8	6675	
CNW34-ZP	CNW3/4	0.750	2-1/4	9610	
CNW78-ZP	CNW7/8	0.875	2-1/2	13080	
CNW1-ZP	CNW1	1.000	2-3/4	17080	
CNW118-ZP	--	1.125	3	21620	

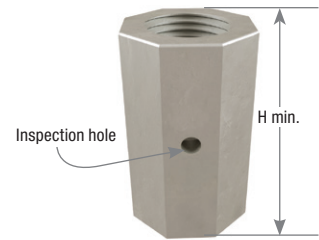

CNW

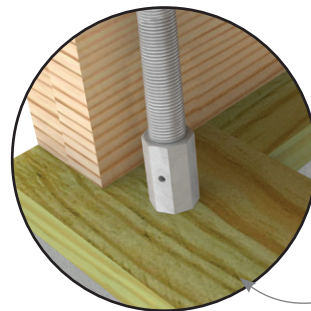

Typical CNW installation

RW Round Washers

Washers are an important component of a threaded rod assembly and should be properly sized for the intended application. They distribute load from the tightened nut and reduce bearing stresses to prevent crushing of the supporting material. This is especially important when tightening over wood.

Materials: ASTM/ANSI B18.22

Finish: None or Zinc Plated (See Chart)

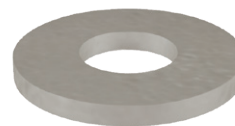

RW

Finish	MiTek Stock No.	Ref. No.	Dia. (in)	Code Ref.
None	RW38	--	0.375	--
	RW12	--	0.500	
	RW58	--	0.625	
	RW34	--	0.750	
	RW78	--	0.875	
	RW1	--	1.000	
	RW118	--	1.125	
Zinc Plated	RW38-ZP	--	0.375	
	RW12-ZP	WASHER1/2-ZP	0.500	
	RW58-ZP	WASHER5/8-ZP	0.625	
	RW34-ZP	WASHER3/4-ZP	0.750	
	RW78-ZP	WASHER7/8-ZP	0.875	
	RW1-ZP	WASHER1-ZP	1.000	
	RW118-ZP	WASHER1-1/8-ZP	1.125	

The HN nut is a standard hex nut manufactured from low carbon ASTM A563 Grade A steel (Proof Load = 90 ksi) which makes it applicable for many common ASTM steel threaded rods of equivalent or lower strength.

Materials: ASTM A563 Grade A

Finish: See chart



HN

Finish	MiTek Stock No.	Ref. No.	Dia. (in)	Code Ref.	Finish	MiTek Stock No.	Ref. No.	Dia. (in)	Code Ref.
None	HN38	--	0.375	--	Zinc Plated	HN38-ZP	NUT3/8	0.375	--
	HN12	--	0.500			HN12-ZP	NUT1/2	0.500	
	HN58	--	0.625			HN58-ZP	NUT5/8	0.625	
	HN34	--	0.750			HN34-ZP	NUT3/4	0.750	
	HN78	--	0.875			HN78-ZP	NUT7/8	0.875	
	HN1	--	1.000			HN1-ZP	NUT1	1.000	
	HN118	--	1.125			HN118-ZP	NUT1-1/8	1.125	

FT / WG Concrete Form Ties & Wedge

The FT form tie and WG wedge system allows concrete wall forms to be made from 2x nominal form lumber by accurately securing them in place while the concrete is poured. This product is intended for a maximum wall height of 4 feet.

FT – Connect 1x and 2x nominal form lumber in low foundation walls up to 4 feet high

WG – V-shaped wedge assures rigidity and consistent form spacing

Materials: FT – 18 gauge, WG – 14 gauge

Finish: G90 galvanizing

Installation:

- Use the Spacing Guide chart to determine spacing between FT units. Each level in chart assumes 12" form boards. Wall thickness from 6" to 12".
- Install with "V" facing up.
- Use (2) WG wedges for each tie. Insert wedge into inside slots for 1x nominal forms and outside slots for 2x nominal forms.
- No walers or stiff-backs are used.
- Vertical ties to keep forms from separating are not included.
- Form deflection may be substantial. Check deflection, if it is critical, and move ties to compensate.
- Forming lumber is assumed to have fb of 1,000 psi.
- **Not recommended for pours greater than 4 feet in height.**



Typical FT/WG installation



WG Wedge

must order separately

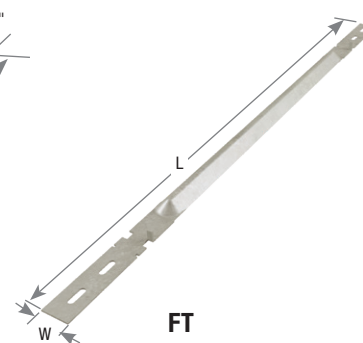

FT

Spacing Guide chart

Concrete Lift Height	Level 1		Level 2		Level 3		Level 4	
	1x	2x	1x	2x	1x	2x	1x	2x
12" or Less	2' 6"	4' 0"	--	--	--	--	--	--
12" – 24"	1' 6"	3' 0"	2' 6"	4' 0"	--	--	--	--
24" – 36"	1' 0"	2' 0"	1' 6"	3' 0"	2' 6"	4' 0"	--	--
36" – 48"	0' 9"	1' 6"	1' 0"	2' 0"	1' 6"	3' 0"	2' 6"	4' 0"

1) Factor of safety against tensile failure of tie is 1.5 or more.

MiTek Stock No.	Ref. No.	Steel Gauge	Dimensions (in)		Wedge Qty	Footing Width or Wall Thickness	Code Ref.
			W	L			
FT6	WT6	18	5/8	10-5/8	2	6	--
FT8	WT8	18	5/8	12-5/8	2	8	
FT10	WT10	18	5/8	14-5/8	2	10	
FT12	WT12	18	5/8	16-5/8	2	12	
WG	W1	14	11/16	3-5/8	--	--	

1) May be used with either 3/4" or 1-1/2" forming materials.

2) Breaking strength is approximately 775 pounds. Space as necessary to prevent form blow-out.

For installation into concrete slabs. The FA3 features a split flange for nailing to both mudsill and stud for greater framing versatility.

Materials: 16 gauge

Finish: G90 galvanizing

Options: See chart for Corrosion Finish Options

Codes: See chart for code references

Installation:

- Use all specified fasteners. See Product Notes, page 18.
- Use a minimum of two anchors per mudsill. An anchor should always be within 12" of the end of each mudsill section.
- Do not rely on these anchors to secure concrete sections together between cold joints.
- Insert into wet concrete (minimum strength of 2,500 psi). Place mudsill after concrete cures. Secure flanges to sill (and stud, if applicable), bending flanges as needed to achieve a tight fit. Fasten as directed in chart.
- Do not use in red clay brick.
- For installation in severe corrosion environments, see Corrosion Information on pages 11-16.

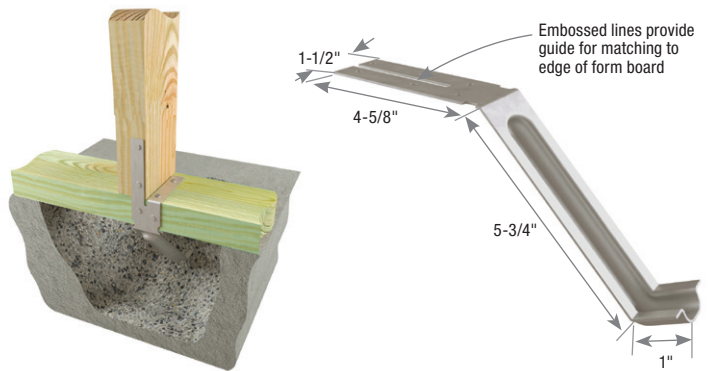

Typical FA3 one-tab-up installation

FA3



Typical FA3 form board installation



Alternate FA3 installation

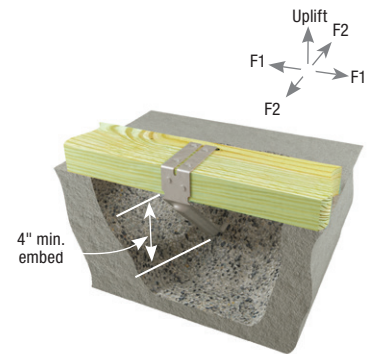

Typical FA3 standard installation in concrete

Concrete & Masonry

MiTek Stock No.	Ref. No.	Steel Ga.	Plate Size	Fastener Schedule ^{1,7}				Min Stemwall Thickness (in)	Installation Type	Concrete ⁶	DF/SP Allowable Loads (Lbs.) ^{2,3,4}			Corrosion Finish	Code Ref.
				Sill Plate		Stud	Type				Uplift 160%	F1 160%	F2 160%		
				Side Qty	Top Qty										
Wind and ASCE Seismic Design A & B															
FA3	--	16	Single 2x	2	4	--	10d x 1-1/2	6	Standard	Uncracked	1350	750	1015	Green	IBC, FL, LA
				2	2	2				Cracked	945	525	710		
			Single 3x	2	4	--	10d x 1-1/2	6	Standard	Uncracked	--	515	--		
				2	2	2				Cracked	945	525	710		
ASCE Seismic Design C-F															
FA3	--	16	Single 2x	2	4	--	10d x 1-1/2	6	Standard	Uncracked	1120	550	890	Green	IBC, FL, LA
				2	2	2				Cracked	830	460	625		
			Single 3x	2	4	--	10d x 1-1/2	6	Standard	Uncracked	--	515	--		
				2	2	2				Cracked	830	460	625		

1) Predrilled holes are not required.
 2) Allowable Stress Design (ASD) values have been adjusted for a load duration factor, C_D, of 1.6 corresponding to a ten-minute load duration (i.e. wind or earthquake loading) in accordance with the NDS. The ASD loads do not apply to loads of other durations.
 3) FA3 capacities are based on using a single-ply 2x sill plate.
 4) Allowable loads are based on a minimum stemwall thickness of 6", minimum distance from the end of the concrete wall of 4" and minimum anchor spacing of 8".
 5) Uplift deformation based on wood connection strength.
 6) Minimum concrete strength f'c = 2,500 psi.
 7) **NAILS:** 10d x 1-1/2 nails are 0.148" dia. x 1-1/2" long.

Corrosion Finish Key ■ Stainless Steel ■ Gold Coat ■ HDG ■ Triple Zinc

Copyright © 2022 MiTek Industries, Inc. All Rights Reserved

FA4 foundation anchors can be installed as a replacement for 5/8" or 1/2" diameter anchor bolts while achieving the same load capacity.

Materials: 16 gauge

Finish: G90 galvanizing

Options: See chart for Corrosion Finish Options

Codes: See chart for code references

Installation:

- The FA4 can be mounted to the form board before placing the concrete or inserted into the wet concrete after it is poured. See Detail A installation.
- Place the mudsill in position after the concrete cures. Secure the FA4 to the mudsill (and stud, if applicable) by bending the flanges as needed for a tight fit and nailing into place with the size and quantity of fasteners specified in the chart.
- For installation in severe corrosion environments, see Corrosion Information on pages 11-16.

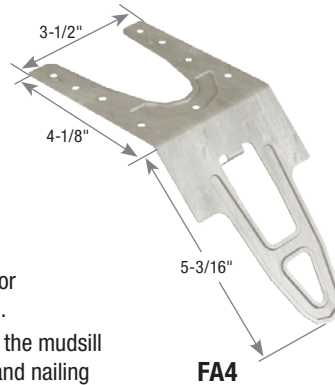

FA4

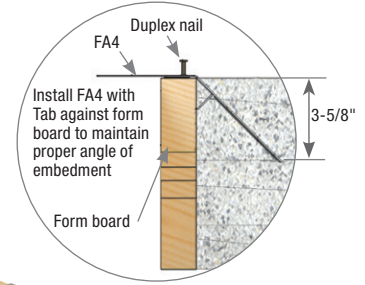

Detail B

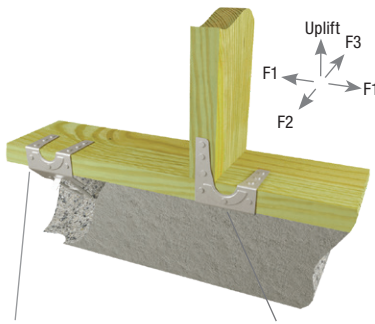

Typical FA4 standard installation

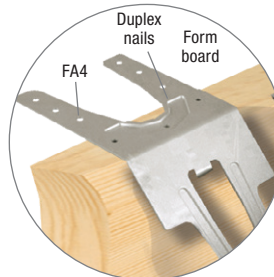

Detail A

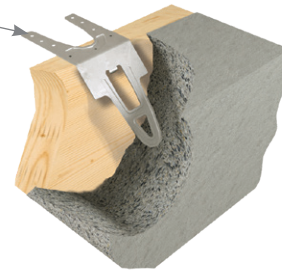

Typical FA4 form board installation

MiTek Stock No.	Ref. No.	GA	Plate Size	Fastener Schedule ⁴				Installation Type	Concrete ³	DF/SP Allowable Loads (Lbs.) ^{1,2}				Corrosion Finish	Code Ref.
				Sill Plate		Stud Qty	Type			Uplift 160%	F1 160%	F2 160%	F3 160%		
				Side Qty	Top Qty										
Wind and ASCE Seismic Design A & B															
FA4	MASA	16	Single 2x	3	6	--	10d x 1-1/2	Standard	Uncracked	905	1460	1070	655	IBC, FL, LA	--
				3	3	3			Cracked	750	1225	750	585		
			Single 3x	5	4	--	10d x 1-1/2	Standard	Uncracked	1070	1130	--	--		
				Cracked	750	1130			--	--					
			Varies	9	--	--	10d x 1-1/2	Two-Tabs-Up	Uncracked	1070	650	650	400		
				Cracked	750	650			650	400					
ASCE Seismic Design C-F															
FA4	MASA	16	Single 2x	3	6	--	10d x 1-1/2	Standard	Uncracked	875	1460	875	655	IBC, FL, LA	--
				3	3	3			Cracked	655	1075	655	510		
			Single 3x	5	4	--	10d x 1-1/2	Standard	Uncracked	780	955	875	515		
				Cracked	655	955			655	510					
			Varies	9	--	--	10d x 1-1/2	Two-Tabs-Up	Uncracked	875	1130	--	--		
				Cracked	655	1075			--	--					

- 1) Allowable loads have been increased 60% for wind and seismic loads; no further increase shall be permitted.
- 2) Allowable loads are based on a minimum stemwall thickness of 6", minimum distance from the end of the concrete wall of 4" and minimum anchor spacing of 8".
- 3) Minimum concrete strength f'c = 2,500 psi.
- 4) **NAILS:** 10d x 1-1/2" nails are 0.148" dia. x 1-1/2" long.

Corrosion Finish Key
■ Stainless Steel ■ Gold Coat
■ HDG ■ Triple Zinc

Prescriptive Spacing to Replace 1/2" or 5/8" Diameter Bolts

Anchor Bolt Diameter	Anchor Bolt Spacing	DF/SP 2x Mudsill O.C. Spacing			Hem-Fir 2x Mudsill O.C. Spacing			Min End Distance	Min C-C Spacing
		Wind	ASCE Seismic Design A & B	ASCE Seismic Design C-E	Wind	ASCE Seismic Design A & B	ASCE Seismic Design C-E		
		1/2"	6'-0"	6'-0"	6'-0"	6'-0"	6'-0"		
5/8"	6'-0"	5'-4"	5'-4"	5'-4"	5'-0"	5'-0"	5'-1/2"	7'-1/4"	
	4'-0"	3'-7"	3'-7"	3'-7"	3'-4"	3'-4"			

- 1) Place anchors not more than 1'-0" from end of each mudsill per code.
- 2) Spacing is based on parallel to mudsill load direction only.
- 3) Concrete shall have a minimum f'c = 2,500 psi.
- 4) Spacing applies to a maximum of 1 in 4 FA4 Foundation Anchors being installed to mudsill and stud.
- 5) Spacing requirements are based on lateral load capacities of anchor bolts published in the 2018 NDS.

ST1-TZ – For installation into concrete slab or poured stemwalls.
The ST1-TZ features a prebent base flange to assure proper anchoring into concrete

ST2-TZ – For installation into concrete slab, poured stemwalls or concrete/masonry.
The ST2-TZ features a prebent base flange to assure proper anchoring into concrete

Materials: 18 gauge
Finish: G-185 galvanizing

Installation:

- Use all specified fasteners. See Product Notes, page 18.
- Use a minimum of two anchors per mudsill. An anchor should always be within 12" of the end of each mudsill section. Follow spacing guidelines in chart.
- Do not rely on these anchors to secure concrete sections together between cold joints.
- Spread sill flanges to mudsill width prior to insertion into wet concrete (minimum strength of 2,500 psi). Alternate installation is possible by inserting unbent flanges through 3/4" center hole pre-drilled in mudsill. Foundation anchors may also be attached to mudsill and then inserted into wet concrete. When installing ST2-TZ into concrete block, fill cells with grout with a minimum strength of 2,500 psi. Concrete block edges may need to be beveled to facilitate installation.
- ST2-TZ in masonry construction shall be installed in the core of the block and grouted with concrete grout designed for that purpose. In no case, shall they be installed in a mortar joint.
- Do not use in red clay brick.

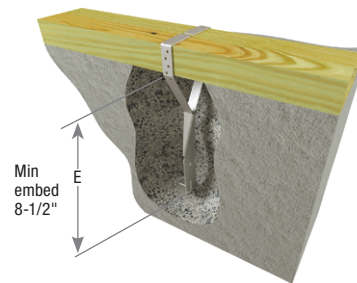

Typical ST1-TZ installation in concrete

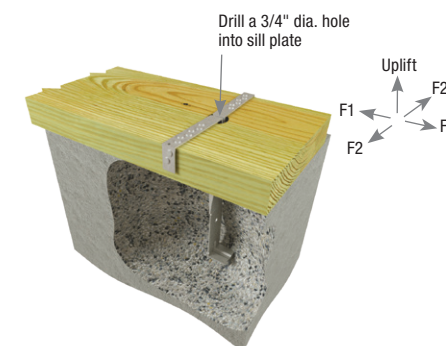

Alternate ST1-TZ installation with 3/4" center hole

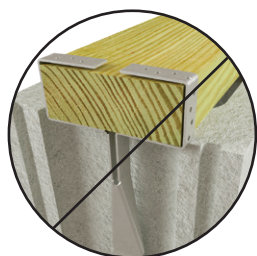

DO NOT install ST1-TZ and ST2-TZ without pre-bending sill flanges in "Y" configuration

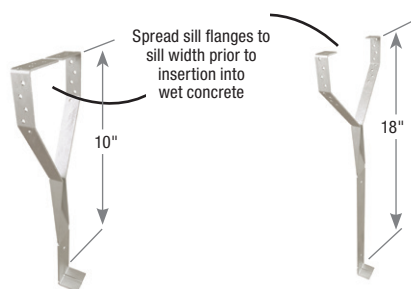

ST1-TZ

ST2-TZ

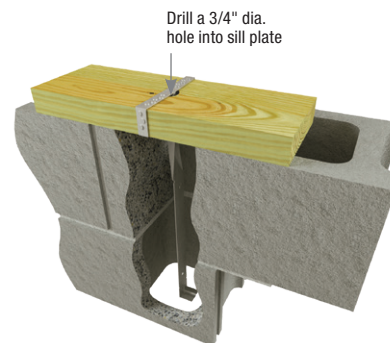

Alternate ST2-TZ installation with 3/4" center hole in mudsill

Plate Size	MiTek Stock No.	Ref. No.	Steel Gauge	Fastener Schedule ⁴				Min. Embed. ³ (E)	Max. Spacing ² (Feet)	DF/SP Allowable Loads (Lbs.) ¹			Corrosion Finish	Code Ref.
				Mudsill Top		Mudsill Side				Uplift	F1	F2		
				Qty	Type	Qty	Type			160%	160%	160%		
2 x 4 - 6	ST1-TZ	MAB15, MAB15Z	18	4	8d x 1-1/2 HDG	4	8d x 1-1/2 HDG	8-1/2"	*3'-3"	825	565	745		--
	ST2-TZ	--	18	4	8d x 1-1/2 HDG	4	8d x 1-1/2 HDG	16-1/2"	*3'-3"	825	565	745		--

1) Allowable loads have been increased 60% for wind or seismic loads; no further increase shall be permitted.
 2) Anchor spacing and design loads assume treated Douglas Fir-Larch with Fc perpendicular @ 625 psi; replaces code prescribed 1/2" anchor bolt with standard washer, spaced 6 ft. on center.
 3) If installed in the alternate configuration, the ST1-TZ shall be embedded 7-1/4" and ST2-TZ 15".
 4) **NAILS:** 8d x 1-1/2 nails are 0.131" dia. x 1-1/2" long.
 *When a 2 x 8 mudsill is used for ST1-TZ or ST2-TZ, maximum spacing is 3 feet unless alternate installation is used.

Corrosion Finish Key ■ Stainless Steel ■ Gold Coat ■ HDG ■ Triple Zinc

MiTek's FWAN-TZ Foundation Wall Anchor is designed to transfer in-plane and out-of-plane foundation wall loads imposed by soil through the joist/blocking into the floor diaphragm. The unique design allows for installations that straddle the joist/blocking eliminating bending stresses in the rim board that result from offset installations.

The FWAN-TZ offers two methods of installation:

1. Centered Installation

- Compatible with joist/blocking up to 3-1/2" wide
- Highest load capacities for transfer of out-of-plane loads into floor framing
- Rim board splices allowed anywhere along the wall

2. Offset Installation

- Installs in the space between the joists/blocking
- Out-of-plane loads are transferred thru the rim board into the floor framing
- Offsets up to 4"

Materials: 16 gauge

Finish: G-185 galvanizing

Codes: IBC, FL, LA

Installation:

- **Centered Installation** – Fill only triangle holes when nailing to the rim board.
- **Offset Installation** – Fill only diamond holes when nailing to the rim board.
- FWAN-TZ must be installed tight to the outside face of the rim board.
- Minimum sill plate thickness is 1-1/2".
- Offset Installations require that the FWAN-TZ be installed within 4" of the joist/blocking.
- For Offset Installations, install with two narrow tabs against rim board. Splices in the rim board are not permitted in the space between the joists/blocking where the FWAN-TZ is installed.
- The designer must specify the anchor bolt size, spacing and embedment necessary to transfer the foundation loads into the sill plate. Stresses in the sill plate must be considered when determining the maximum spacing of the anchor bolts.

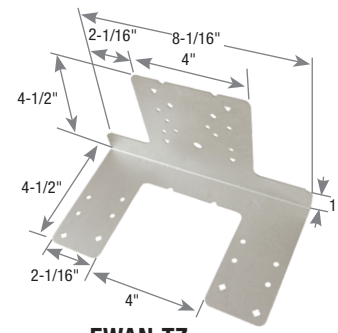
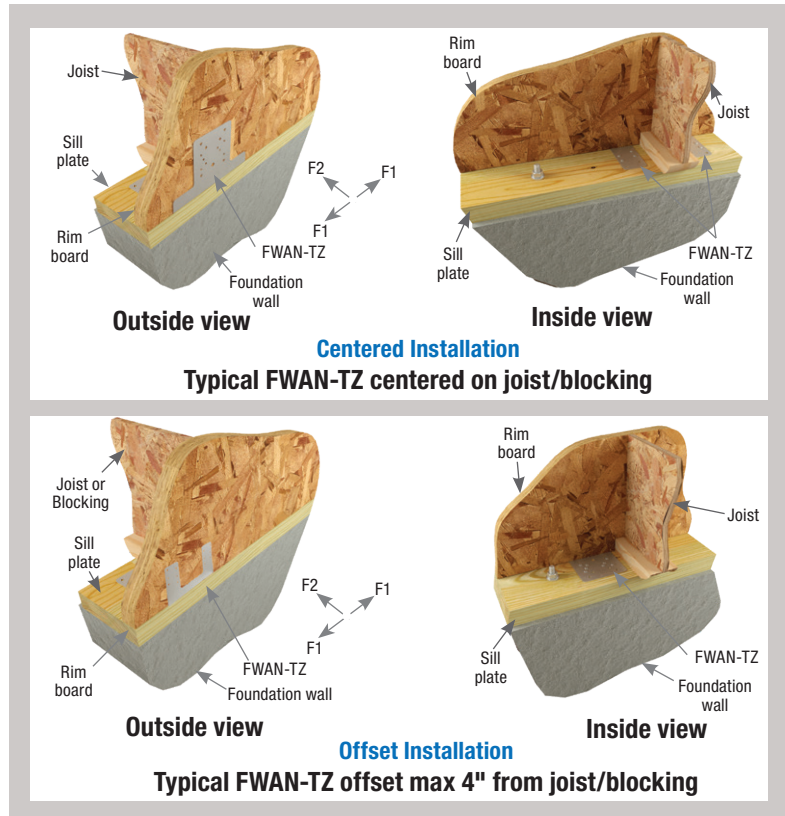

FWAN-TZ

MiTek Stock No.	Ref. No.	Sill Plate	Fastener Schedule ⁶				Rim Board Material	DF/SP Allowable Load (Lbs.) ^{1,2}						Hem-Fir Allowable Load (Lbs.) ^{1,2}						Corrosion Finish	Code Ref.
			Sill Plate		Rim Board			F1 ^{3,4}			F2 ^{3,4}			F1 ^{3,4}			F2 ^{3,4}				
			Qty	Type	Qty	Type		90%	100%	160%	90%	100%	160%	90%	100%	160%	90%	100%	160%		
FWAN-TZ	FWANZ	2x4, 2-2x4, 3x4, 4x4	8	10d x 1-1/2 HDG	4	10d x 1-1/2 HDG	Centered on Joist/Blocking												IBC, FL, LA		
							1-1/8" OSB	415	415	415	915	1000	1070	330	330	330	800	855			855
							2x Rim	455	500	525	915	1000	1385	420	420	420	800	870			1110
		1-3/4" LVL	455	500	525	915	1000	1385	420	420	420	800	870	1110							
		2x6, 2-2x6, 3x6, 4x6	12	10d x 1-1/2 HDG	4	10d x 1-1/2 HDG	1-1/8" OSB	415	415	415	1370	1500	1475	330	330	330	1180	1180			1180
		2x Rim					455	500	525	1370	1500	1660	420	420	420	1200	1310	1330			
	1-3/4" LVL	455					500	525	1370	1500	1660	420	420	420	1200	1310	1330				
	Offset from Joist Blocking (Max Offset 4")																				
	2x4, 2-2x4, 3x4, 4x4	8	10d x 1-1/2 HDG	4	10d x 1-1/2 HDG	1-1/8" OSB	415	415	415	525	525	525	330	330	330	420	420	420			
						2x Rim	455	500	525	915	995	995	420	420	420	795	795	795			
						1-3/4" LVL	455	500	525	915	995	995	420	420	420	795	795	795			
	2x6, 2-2x6, 3x6, 4x6	12	10d x 1-1/2 HDG	4	10d x 1-1/2 HDG	1-1/8" OSB	415	415	415	525	525	525	330	330	330	420	420	420			
2x Rim						455	500	525	995	995	995	420	420	420	795	795	795				
1-3/4" LVL						455	500	525	995	995	995	420	420	420	795	795	795				

1) Allowable loads have been reduced 10% for permanent sustained loads, no further reduction is required.
 2) Allowable loads have been increased 60% for wind or seismic loads; no further increase shall be permitted.
 3) F1 loads are parallel to the sill plate.
 4) F2 loads are perpendicular toward the sill plate.

5) The designer must specify the type, size and spacing of fasteners connecting the sill plate to the foundation wall.
 6) **NAILS:** 10d x 1-1/2 nails are 0.148" dia. x 1-1/2" long.
 New products or updated product information are designated in **blue font**.

Corrosion Finish Key ■ Stainless Steel ■ Gold Coat ■ HDG ■ Triple Zinc

SRCP Sill Retrofit Connector Plate

Concrete & Masonry

MiTek's SRCP Sill Retrofit Connector Plate is designed as a retrofit sill-to-foundation connection that can be installed where there is minimal space between the floor framing and top of the foundation wall. The economical design is targeted for use in seismic regions and yet is also suitable for use as a supplementary connection in high wind areas.

The SRCP Sill Retrofit Connector Plate can be installed without shims anywhere the face of the sill plate is within 1/2" of the face of the foundation wall.

Materials: 10 gauge

Finish: G90 galvanizing

Codes: See chart for code references

Installation:

- For sill plate setbacks from 1/2" to 1-1/2", install a wood shim (a minimum of 15" long) tight against the sill plate and flush with the foundation wall. See Figure 3.

Note: For any installations with a sill plate setback, a shim plate is required to transfer load in the F3 direction.

- Install the five MiTek WS3 structural wood screws (included) in the slotted holes of the SRCP plate, thru the shim (if applicable) and into the sill plate. MiTek's WS3 structural wood screws should be installed 3/4" above the bottom of the sill plate (i.e. centered in the narrow face for a 2x sill).
- Drill and install two 1/2" diameter Power-Stud® anchors (or equivalent) into the foundation wall. See manufacturer's literature for proper installation of post-installed anchors.

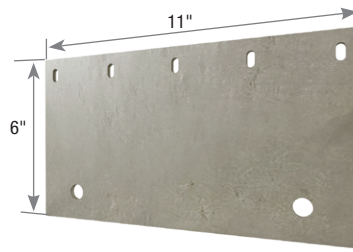

SRCP

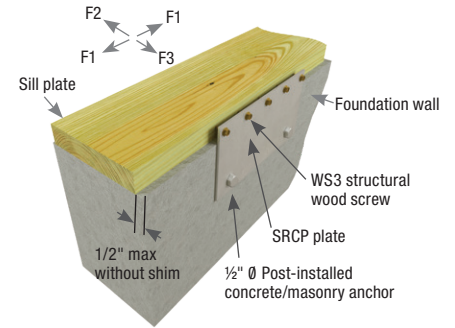

Typical SRCP installation without shim, 1/2" max setback

Figure 1

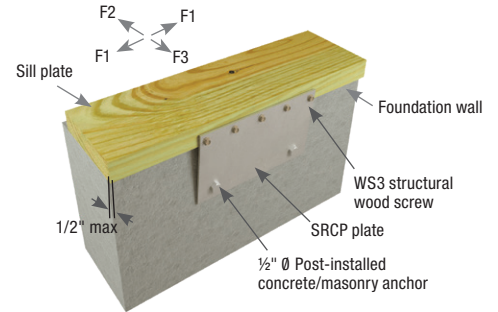

Typical SRCP installation without shim, 1/2" max overhang

Figure 2

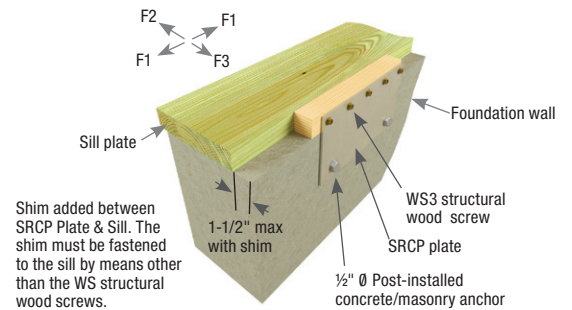

Typical SRCP installation with shim, 1-1/2" max setback

Figure 3

MiTek Stock No.	Ref. No.	Steel Gauge	Dimensions (in)		Maximum Spacing to Replace 1/2" or 5/8" Anchor Bolt	Fastener Schedule				Installation Type	DF/SP Allowable Load (Lbs.) ¹			Code Ref.
			W	H		Concrete ^{3,4}		Sill Plate ²			F1 160%	F2 160%	F3 160%	
						Qty	Dia.	Qty	Type					
SRCP	FRFP	10	11	6	6'	2	1/2	5	WS3	Figure 1	1560	360	--	--
										Figure 2	1560	--	360	
										Figure 3 ⁵	1560	360	360	IBC, FL, LA

1) Allowable loads have been increased 60% for wind or seismic loads; no further increase shall be permitted.
 2) MiTek's WS3 structural wood screws are 1/4" dia. x 3" long and are included with each SRCP connector.
 3) Use 1/2" diameter Power-Stud® anchors with minimum 3" embedment or equivalent.
 4) Minimum concrete strength f'c = 2,500 psi.
 5) The shim must be fastened to the sill by means other than MiTek's WS3 structural wood screws.

The SRC Sill Retrofit Connector has been engineered as a ductile retrofit for older buildings in high seismic zone regions that require additional reinforcement. It can be installed where there is minimal space between the floor framing and top of the foundation wall. The SRC can also be used to reinforce buildings in high velocity wind zones.

The two-piece design easily adjusts to foundations of varying thickness and can also be used where the sill plate may not be parallel to the face of the foundation wall.

Materials: Channel - 12 gauge, Plate - 10 gauge

Finish: G90 galvanizing

Codes: IBC, FL, LA

Installation:

- Use all specified fasteners.
- MiTek's WS6 structural wood screws are supplied with each SRC connector.
- **Contact Customer Service for offsets more than 2-1/2".**

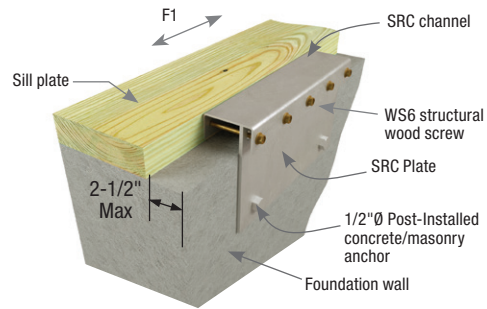

Typical SRC installation on rectangular foundation

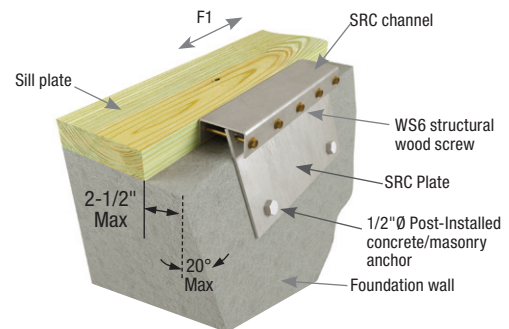

Typical SRC installation on trapezoidal foundation

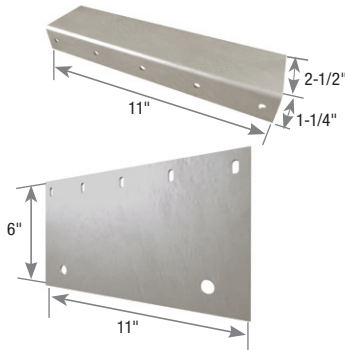

SRC components

Recommended Installation Sequence

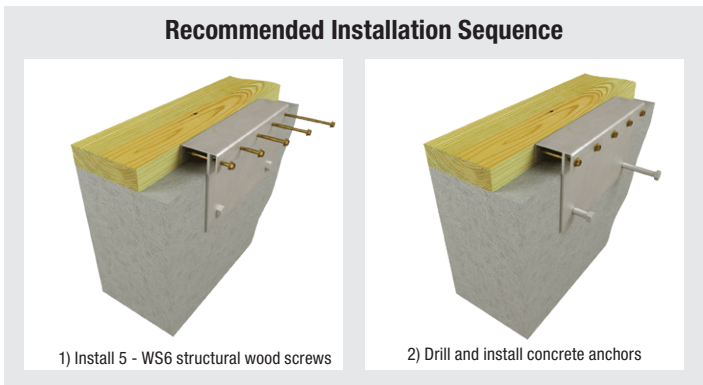

MiTek Stock No.	Ref. No.	Components	Steel Gauge	Dimensions (in)		Maximum Spacing to Replace 1/2" or 5/8" Anchor Bolt	Fastener Schedule				DF/SP Allowable Load (Lbs.) ¹	Code Ref.
				W	H		Concrete ^{3,4}		Sill Plate ²			
							Qty	Dia.	Qty	Type	F1	
SRC	URFP	Channel	12	11	1-1/4	6'	2	1/2	5	WS6	1405	IBC, FL, LA
		Plate	10	11	6							

1) Allowable loads have been increased 60% for wind or seismic loads; no further increase shall be permitted.
 2) MiTek's WS6 structural wood screws are 1/4" dia. x 6" long and are included with each connector.
 3) Use 1/2" dia. Power-Stud® anchors with minimum 3" embedment or equivalent.
 4) Minimum concrete strength f'c = 2,500 psi.

The SFJA ties floor joists directly to foundations with bolt fastening.

Materials: 12 gauge
Finish: G90 galvanizing

Installation:

- Use all specified fasteners. See Product Notes, page 18.
- A design professional must specify anchor bolt type, length, and embedment. Anchor bolts are laterally loaded. Follow installation instructions for epoxy adhesive.

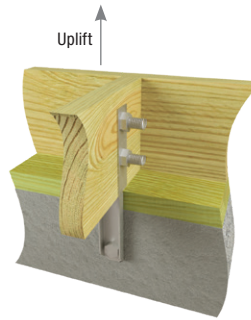

Typical SFJA installation

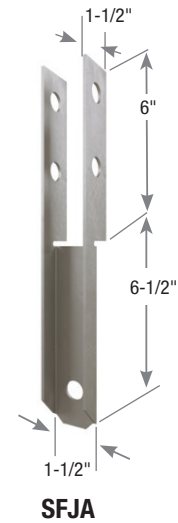

SFJA

Concrete & Masonry

MiTek Stock No.	Ref. No.	Steel Gauge	Fastener Schedule				DF/SP Allowable Loads (Lbs.) ¹		Code Ref.
			Anchor Bolts		Framing Bolts ²		Uplift 160%		
			Qty	Dia.	Qty	Dia.			
SFJA	FJA	12	1	5/8	2	5/8	1305	--	

- 1) Allowable loads have been increased 60% for wind or seismic loads; no further increase shall be permitted.
- 2) All bolts shall meet or exceed the specifications of ASTM A 307.
- 3) Fasteners shall be installed to fully grouted and reinforced masonry units (CMU) type S or better mortar or reinforced concrete (f'c = 2,500 psi at 28 days).

RP Retro Plate

Uses heavy gauge HRPO steel and a large surface area to distribute seismic forces on masonry exteriors.

Materials: 3/8" plate
Finish: Primer
Options: See Chart for Corrosion Finish Options

Installation:

- Install with a 3/4" diameter steel threaded rod.

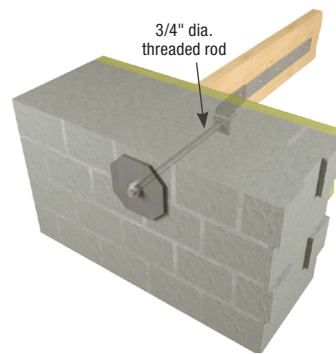

Typical RP6 installation

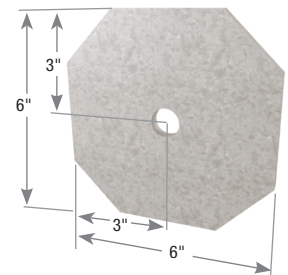

RP6

MiTek Stock No.	Ref. No.	Corrosion Finish	Code Ref.
RP6	RP6		--

Corrosion Finish Key ■ Stainless Steel ■ Gold Coat ■ HDG ■ Triple Zinc

Copyright © 2022 MiTek Industries, Inc. All Rights Reserved

KGLB – Single bolt, bearing only

KGLBT – Double bolt with structural tee provides uplift and horizontal resistance

KHGLB – Double bolt design provides uplift and horizontal resistance

Materials: Flanges – 1/4" steel
 Bearing Plate – See chart for "T" dimension
 Anchor Dowels – 3/4" x 12" rebar

Finish: Primer

Options: Consult MiTek for non-catalog variations.

Installation:

- Use all specified fasteners. See Product Notes, page 18.
- Bolt holes shall be a minimum of 1/32" to a maximum of 1/16" larger than the bolt diameter.
- Concrete or masonry walls must be checked by a design professional for adequacy to resist lateral or uplift loads transferred from the beam seat anchor.

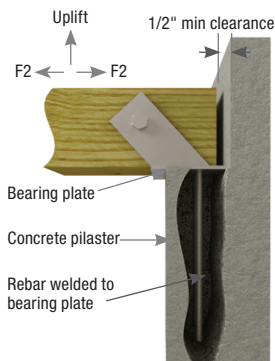

Typical KGLB installation

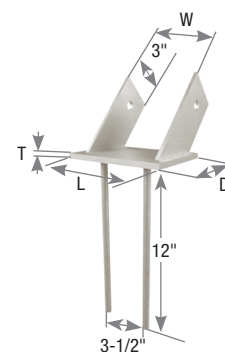

KGLB

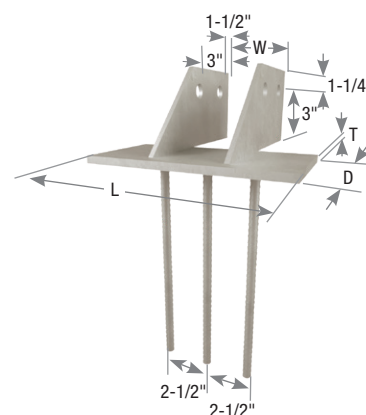

KHGLB

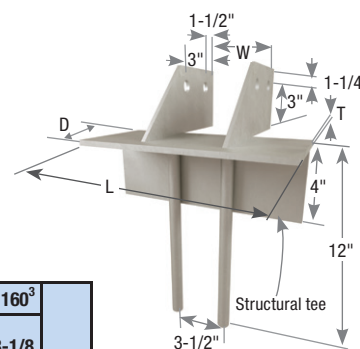

KGLBT

KGLB Load Table

MiTek Stock No.	Ref. No.	Dimensions (in)				Bolt Schedule		Allowable Bearing Loads (Lbs.) ^{1,4,5}		Code Ref.
		W	L	T	D	Qty	Dia	Masonry @ 375 psi ²	Concrete ³	
KGLB5A	GLB5A	5-1/4	7	1/4	5	1	5/8	11790	11790	--
KGLB5B	GLB5B	5-1/4	7	3/8	6	1	5/8	14145	14145	
KGLB5C	GLB5C	5-1/4	7	3/8	7	1	5/8	16505	16505	
KGLB5D	GLB5D	5-1/4	7	3/8	8	1	5/8	18860	18860	
KGLB7A	GLB7A	6-7/8	9	1/4	5	1	3/4	15525	15525	
KGLB7B	GLB7B	6-7/8	9	3/8	6	1	3/4	18630	18630	
KGLB7C	GLB7C	6-7/8	9	3/8	7	1	3/4	21735	21735	
KGLB7D	GLB7D	6-7/8	9	3/8	8	1	3/4	24840	24840	

- 1) Beams must fully bear on plates.
- 2) The loads are based on the bearing value listed times the bearing area equal to W x D. (Note that full bearing plate area is not used.) Bearing loads shall be reduced where limited by wood bearing on the plate.
- 3) The loads on concrete are based on allowable wood bearing stress perpendicular to the grain of 460 psi and actual beam width times beam bearing length.
- 4) Designer shall specify minimum edge and spacing requirements in masonry or concrete structure.
- 5) Concrete or masonry support structure is assumed adequate to support loads listed.

KHGLB / KGLBT Load Table

MiTek Stock No.	Ref. No.	Dimensions (in)				Bolt Schedule		Allowable Bearing Loads (Lbs.) ^{1,5}					Uplift 160 ³	Code Ref.	
		Range W	Plate			Qty	Dia. (in)	On Concrete with Beam Width ²				F2 ^{3,4} 160%			Min. 3-1/8 Beam Width (W)
D	L		T	Masonry @ 375 psi	5-1/8			6-3/4	8-3/4	10-3/4					
KHGLBA	HGLBA	3-1/4 to 9	5	10	3/8	2	3/4	18750	11790	15525	20125	--	9870	3905	--
KHGLBB	HGLBB	3-1/4 to 9	6	10	3/8	2	3/4	22500	14145	18630	24150	--	9870	3905	
KHGLBC	HGLBC	3-1/4 to 9	7	10	3/8	2	3/4	26250	16505	21735	28175	--	9870	3905	
KHGLBD	HGLBD	3-1/4 to 9	8	10	3/8	2	3/4	30000	18860	24840	32200	--	9870	3905	
KGLBT512	--	3-1/4 to 11	5-1/4	12	5/16	2	3/4	24750	12965	17080	22140	27200	9870	3905	
KGLBT612	--	3-1/4 to 11	6-1/2	12	3/8	2	3/4	29250	15325	20185	26165	32145	9870	3905	
KGLBT516	--	3-1/4 to 15	5-1/4	16	5/16	2	3/4	27200	12965	17080	22140	27200	9870	3905	
KGLBT616	--	3-1/4 to 15	6-1/2	16	3/8	2	3/4	32145	15325	20185	26165	32145	9870	3905	
KGLBT520	--	3-1/4 to 19	5-1/4	20	5/16	2	3/4	27200	12965	17080	22140	27200	9870	3905	
KGLBT620	--	3-1/4 to 19	6-1/2	20	3/8	2	3/4	32145	15325	20185	26165	32145	9870	3905	

- 1) Beams must fully bear on plates.
- 2) The loads on concrete are based on allowable wood bearing stress perpendicular to the grain of 460 psi and actual beam width times beam bearing length.
- 3) Allowable loads have been increased 60% for wind or seismic loads and are based on bolt in wood values only. Loads assume concrete or masonry structure is adequate to resist loads in those directions.
- 4) Loads must be reduced if the allowable lateral load (F2) for masonry or concrete column governs.
- 5) Designer shall specify minimum edge and spacing requirements in masonry or concrete structure.

Connects girder beams to foundation walls and eliminates the need to block out pockets or inserts while forming foundation.

Materials: 12 gauge

Finish: Primer

Options: See Specialty Options Chart. Consult MiTek for non-catalog design variations

Codes: IBC, FL, LA

Installation:

- Use all specified fasteners. See Product Notes, page 18.
- H dimension assumes 2x mudsill. For 3x or larger mudsill, please contact factory.
- The 1-1/2" hole, centered in the saddle, allows for installation over any protruding foundation bolts. This is not required.
- Placement of a wood sill over the top of the KGH top flange is required to achieve allowable loads.

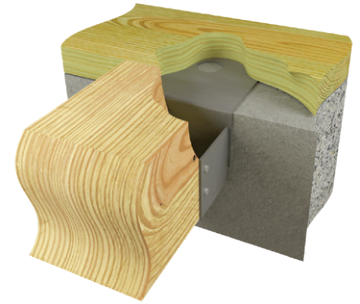

Typical KGH installation

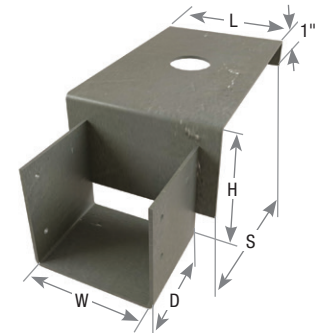

KGH

Girder Size	MiTek Stock No.	Ref. No.	Steel Gauge	Dimensions (in)					Fastener Schedule ¹		DF/SP Allowable Loads (Lbs.)		S-P-F Allowable Loads (Lbs.)		Code Ref.
				W	L	D	S	H	Qty	Type	100%	125%	100%	125%	
4 x 6	KGH46-6	GH46-6	12	3-9/16	5	3-1/4	6	4	4	16d	2200	2200	1725	1725	IBC, FL, LA
4 x 6	KGH46-8	GH46-8	12				8								
4 x 8	KGH48-6	GH48-6	12	3-9/16	5	3	6	6	4	16d	2200	2200	1725	1725	
4 x 8	KGH48-8	GH48-8	12				8								
6 x 6	KGH66-6	GH66-6	12	5-1/2	6-1/4	3	6	4	4	16d	3070	3070	2410	2410	
6 x 6	KGH66-8	GH66-8	12				8								
6 x 8	KGH68-6	GH68-6	12	5-1/2	6-1/4	3	6	6	4	16d	3070	3070	2410	2410	
6 x 8	KGH68-8	GH68-8	12				8								

1) **NAILS:** 16d nails are 0.162" dia. x 3-1/2" long.

Specialty Options Chart –

refer to Specialty Options pages 320 and 322-323 for additional details.

Option	Skewed ^{1,2}	Saddle
Range	1° to 45°	--
Allowable Loads	100% of table load.	100% of table load per side.
Ordering	Add <i>SK</i> , angle required, right (<i>R</i>) or left (<i>L</i>), and square cut (<i>SQ</i>) or bevel cut (<i>BV</i>) to product number. Ex. KGH46-6_SK45R_BV	Add <i>SA</i> , and saddle width required to product number. Ex. KGH46-6_SA=5-1/2"

- 1) Skewed hangers with skews greater than 15° may have all joist nailing on outside flange.
- 2) For skewed hangers, the required cut type (square or bevel) of joist member may vary based on skew angle and width of hanger. Some square cut hangers will require custom pricing due to welded back plate.

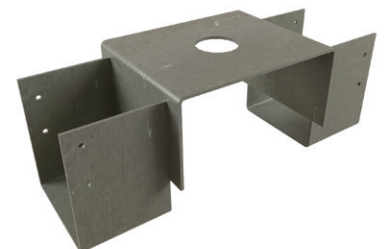

KGH saddle Specialty Option

HOLD-DOWNS



HOLDOWNS

66-79

Foundation Straps

73-77

Holdowns

66-69, 72

Purlin Anchors

78-79

Tension Ties

70-71



PHD predeflected holdowns feature the predeflected base, minimizing deflection while providing uplift resistance. Installs with screws eliminating the need for predrilling and potential fastener slip. No thru bolts to countersink.

DTB-TZ is a light capacity holddown for single 2x installations.

Materials: See chart

Finish: G90 galvanizing; DTB-TZ – G-185 galvanizing

Codes: IBC, FL, LA

Installation:

- Use all specified fasteners. See Product Notes, page 18.
- **Place the PHD over the anchor bolt, no washer is required. Washer is required on DTB installations.**
- Install with MiTek's code evaluated WS15-EXT (1/4" dia. x 1-1/2" long) and WS3 (1/4" dia. x 3" long) structural wood screws, which are provided with the holddown.
- Tighten anchor bolt nuts finger tight to base plus 1/3 to 1/2 additional turns with a wrench.
- **PHD Predeflected Holdowns may be installed off sill plate with no load reduction.** Reference page 72 for more information.
- The design engineer may specify any alternate anchorage calculated to resist the tension load for a specific application. Anchorage exposure length should take the bearing plate height of 1-5/8" into account, anchor bolt thread should visibly extend above nut.
- If used to anchor a built-up post, such as a double 2x4, the post component shall be designed to act as a single unit. Holddown fasteners specified shall not be considered to attach multiple plies together.
- For anchorage options see STB/STBL Anchor Bolt section on pages 49-50.



Typical PHD5A installation

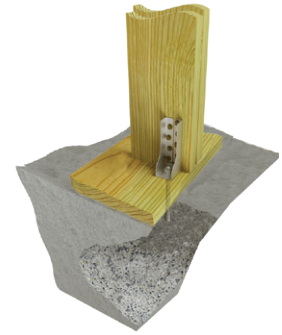

Typical DTB-TZ installation

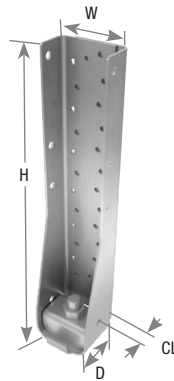

PHD8

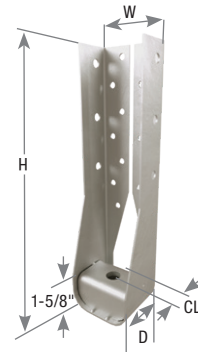

PHD5A

(PHD2A / PHD4A similar)

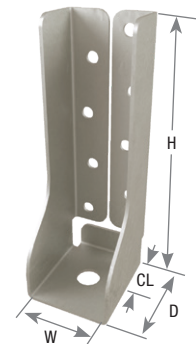

DTB-TZ

MiTek Stock No.	Ref. No.	Steel Gauge	Dimensions (in)				Fastener Schedule				Allowable Loads (Lbs.) ^{1,4,7}			Corrosion Finish	Code Ref.
			W	H	D	CL ⁸	Anchor Bolts ²		Screws ⁶		DF/SP	S-P-F	Deflection Δ (in) at 160% ^{3,5}		
							Qty	Dia.	Qty	Type	Tension 160%	Tension 160%			
DTB-TZ	DTT2Z	14	1-13/16	6	2-1/4	1-1/8	1	1/2	8	WS15-EXT	1835	1510	0.119	Green	IBC, FL
PHD2A	HDU2-SDS2.5	14	3	7-3/4	2-5/8	1-3/8	1	5/8	6	WS3	3215	2700	0.155	Blue	IBC, FL, LA
PHD4A	HDU4-SDS2.5	14	3	9-3/4	2-5/8	1-3/8	1	5/8	10	WS3	5215	4380	0.137	Blue	
PHD5A	HDU5-SDS2.5	14	3	11-11/16	2-5/8	1-3/8	1	5/8	14	WS3	6525	5480	0.135	Blue	
PHD8	HDU8-SDS2.5	12	3-1/4	16-1/2	3	1-3/8	1	7/8	24	WS3	8185	6875	0.062	Blue	

- 1) Allowable loads have been increased 60% for wind and seismic loads; no further increase shall be permitted.
- 2) The designer must specify anchor bolt type, length, and embedment.
- 3) Deflections are derived from static, monotonic load tests of devices connected to DF-L wood members with specified fasteners.
- 4) The designer shall consider the effect of compression, bearing, tension, and combined bending due to device eccentricity when applicable.
- 5) The PHD/PHDA may be elevated off the sill and may increase deflection. Reference page 72 for more information.
- 6) MiTek's WS15-EXT (1/4" dia. x 1-1/2" long) and WS3 (1/4" dia. x 3" long) structural wood screws are included with holdowns.
- 7) For PHD holdowns, minimum post thickness is 3". Consult MiTek for installations less than 3".
- 8) "CL" denotes the distance between the post and center of the anchor bolt.

Corrosion Finish Key ■ Stainless Steel ■ Gold Coat ■ HDG ■ Triple Zinc

Engineered for high capacity with minimum deflection and low eccentricity. Installs with screws eliminating the need for predrilling and potential fastener slip. No thru bolts to countersink.

Materials: See chart

Finish: Primer

Codes: IBC, FL, LA

Installation:

- Use all specified fasteners. See Product Notes, page 18.
- Place holdown over anchor bolt and drive screws into post.
- Tighten anchor bolt nuts finger tight to base plus 1/3 to 1/2 additional turns with a wrench.
- Holdown may be installed off of the plate with no load reduction. Reference page 72 for more information.
- If used to anchor a built-up post, such as a double 2x4, the post component shall be designed to act as a single unit. Holddown fasteners specified shall not be considered to attach multiple plies together.



Typical UPHD installation

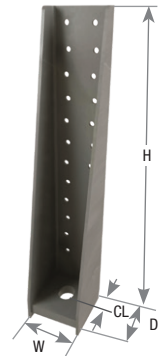

UPHD

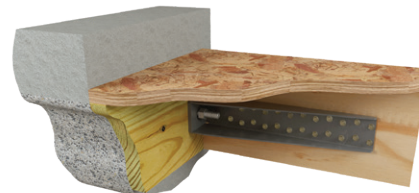

Typical UPHD concrete wall installation

MiTek Stock No.	Ref. No.	Steel Gauge	Dimensions (in)				Fastener Schedule				Allowable Loads (Lbs.) ^{1,5,7}			Code Ref.
			W	H	D	CL	Anchor Bolts ²		Screws ⁶		DF/SP	S-P-F	Deflection Δ (in) at 160% ³	
							Qty	Dia.	Qty	Type	Tension 160%	Tension 160%		
UPHD8	HDQ8-SDS3	10	3-1/4	17-1/2	3-1/8	1-3/8	1	7/8	24	WS3	9165	7695	0.075	IBC, FL
UPHD9	HDU11-SDS2.5	10	3-1/4	17-1/4	3-1/2	1-1/2	1	1	24	WS3	11270	9465	0.057	
UPHD11	HHDQ11-SDS2.5	7	3	15-1/8	3-1/2	1-1/2	1	1	24	WS3	14395	12090	0.077	
UPHD14	HDU14-SDS2.5, HHDQ14-SDS2.5	7	3	18-3/4	3-1/2	1-1/2	1	1	30	WS3	16695	14020	0.082	

1) Allowable loads have been increased 60% for wind and seismic loads; no further increase shall be permitted.
 2) The designer must specify anchor bolt type, length, and embedment.
 3) Deflections are derived from static, monotonic load tests of devices connected to DF-L wood members with specified fasteners.
 4) The designer shall consider the effect of compression, bearing, tension, and combined bending due to device eccentricity when applicable.
 5) The UPHD may be elevated off the sill and may increase deflection. Reference page 72 for more information.
 6) MiTek's WS3 structural wood screws are 1/4" dia. x 3" long and are included with UPHD models.
 7) Minimum post thickness is 3" or greater. Consult MiTek for installations less than 3".

TD – Different welded configurations and sizes achieve a great deal of versatility within the TD series.

TDX – The TDX2 and TDX5 feature formed designs, all others are welded. All are self-jigging.

All models, except TD2, TD5, and TD7, feature a self-jigging design with code required end distances built in. (End distance = 7 bolt diameters from the top of the sill to the center of the first bolt hole in the studs or post.)

Materials: See chart

Finish: TDX5– G90 galvanizing; TDX2-TZ – G-185 galvanizing; All others – Primer

Codes: See chart for code references

Patents: U.S. Patent No. 5,092,097 – TDX2

Installation:

- Use all specified fasteners. See Product Notes, page 18.
- Do not use lag bolts. Washers are not required for anchor bolts or between holdown and bolt hex head, but standard washers should be used against stud or post under the nut. See page 51 for BP/LBP Bearing Plates.
- Bolt holes should be a minimum of 1/32" to a maximum of 1/16" larger than the bolt diameter (as per NDS® specifications).
- See pages 49-50 for STB Anchor Bolt section for anchorage options. A design professional may specify alternate anchorage with conventional anchor bolts.
- A design professional shall determine the adequacy of the stud to resist published loads. Holdown fasteners specified shall not be considered to attach multiple plies together.
- Self-jigging models are designed to provide the required minimum end distance of 7 bolt diameters from the bottom of the stud or post to the centerline of the first bolt hole.
- Tighten anchor bolt nuts finger tight to base plus 1/3 to 1/2 additional turns with a wrench. Wood members may shrink over time; if possible, nut tightness should be checked periodically.
- If used to anchor a built-up post, such as a double 2x4, the post component shall be designed to act as a single unit.



Typical TDX6 installation

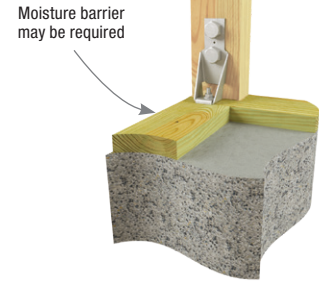

Typical TDX2-TZ installation

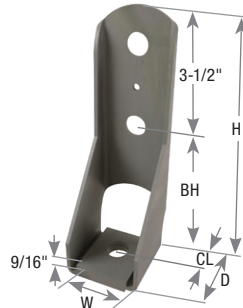

TDX6

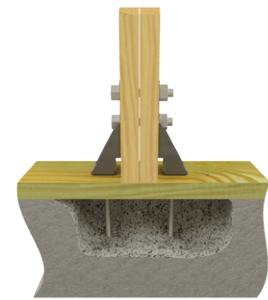

Typical TDX2-TZ back-to-back installation

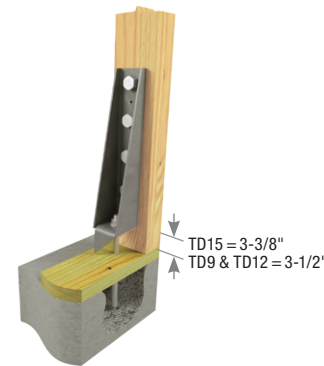

Typical TD15 installation

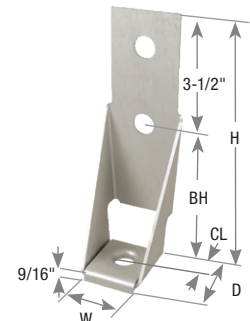

TDX2-TZ

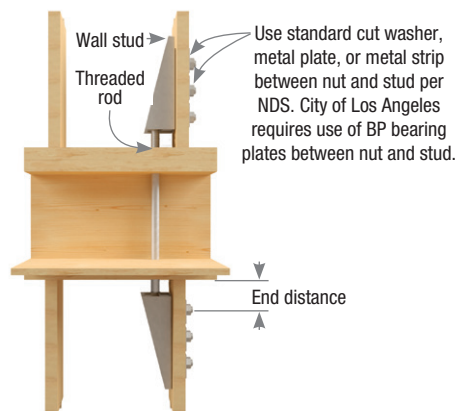

Holdown installation between floors

Continued on next page

MiTek Stock No.	Ref. No.	Steel Gauge	Dimensions (in)					Fastener Schedule ⁴			Min. Required Bolt End Distance ⁵	Length of Bolt in Vertical Member	DF/SP Allowable Tension Loads (Lbs.) ^{1,2,3}		Corrosion Finish	Code Ref.
			W	H	D	BH	CL	Anchor Bolt Dia.	Bolts				160%	Δ (in) ⁸		
									Qty	Dia.						
TD5	--	7	3	6-3/8	3-3/4	1-1/4	2-1/8	3/4	2	3/4	5-1/4	1-1/2"	2405	0.122 ⁶		
												3"	4040	0.140 ⁶		
												3-1/2"	4040	0.140 ⁶		
												5-1/2"	4040	0.140 ⁶		
TD7	--	3	3-3/8	11-7/8	3-5/8	3-3/8	2-1/8	1-1/8	3	7/8	6-1/8	1-1/2"	4600	0.095 ⁶		
												3"	8195	0.125 ⁶		
												3-1/2"	9420	0.139 ⁶		
												5-1/2"	10510	0.152 ⁶		
TD9	--	3	3-3/8	16-1/2	4-1/4	4-1/8	2-1/8	1-1/8	3	1	7	3"	9330	0.146 ⁶	IBC, FL	
												3-1/2"	10715	0.160 ⁶		
												4-1/2"	13370	0.169 ⁶		
												5-1/2"	13500	0.170 ⁶		
TD12	HD12	3	3-1/2	20-1/2	4-1/4	4-1/8	2-1/8	1-1/8	4	1	7	3"	12070	0.132 ⁶		
												3-1/2"	13960	0.142 ⁶		
												4-1/2"	16550	0.185 ⁶		
												5-1/2"	16550	0.185 ⁶		
TD15	HD19	3	3-1/2	25	4-3/8	4-1/4	2-1/8	1-1/4	5	1	7	3"	14505	0.167 ⁶		
												3-1/2"	16845	0.178 ⁶		
												4-1/2"	17755	0.202 ⁶		
												5-1/2"	17755	0.202 ⁶		
TDX2-TZ	HD3B	12	2-1/16	8-1/8	2-3/4	4-1/2	1-1/2	5/8	2	5/8	4-1/2	1-1/2"	1920	0.150 ⁶		
												3"	3295	0.169 ⁶		
												3-1/2"	3295	0.169 ⁶		
												5-1/2"	3295	0.169 ⁶		
TDX5	--	10	2-1/2	9-3/8	3-7/8	6	2	3/4	2	3/4	5-1/4	1-1/2"	2340	0.079 ⁶		
												3"	4515	0.151 ⁶		
												3-1/2"	4530	0.151 ⁶		
												4-1/2"	4530	0.151 ⁶		
TDX6	HD5B	7	3-1/2	11-1/8	3-3/4	6-1/8	2	7/8	2	7/8	6-1/8	1-1/2"	2835	0.093 ⁶	IBC, FL, LA	
												3"	5350	0.128 ⁶		
												3-1/2"	5805	0.138 ⁶		
												4-1/2"	5805	0.138 ⁶		
TDX8	--	7	3-1/2	14-5/8	3-3/4	6-1/8	2	7/8	3	7/8	6-1/8	1-1/2"	4160	0.060 ⁶		
												3"	7870	0.132 ⁶		
												3-1/2"	9125	0.172 ⁶		
												4-1/2"	9125	0.172 ⁶		
TDX10	HD7B	7	3-1/2	18-1/8	3-3/4	6-1/8	2	7/8	4	7/8	6-1/8	3"	10140	0.128 ⁶		
												3-1/2"	10570	0.137 ⁶		
												4-1/2"	10570	0.137 ⁶		
												5-1/2"	10570	0.137 ⁶		
TDX14	HD9B	3	3-1/2	20-1/2	3-5/8	7	2-1/8	1	4	1	7	3"	11995	0.117 ⁶		
												3-1/2"	13895	0.146 ⁶		
												4-1/2"	15015	0.166 ⁶		
												5-1/2"	15015	0.166 ⁶		

- 1) Allowable loads shown are for single shear connections and may be doubled for back-to-back installations. The designer must verify post and anchor bolt capacities.
 - 2) Allowable loads have been increased 60% for wind or seismic loads; no further increase shall be permitted.
 - 3) The designer must specify stud or post to resist published load values.
 - 4) The designer must specify anchor bolt type, length, and embedment.
 - 5) TD models - install TD holdown raised off of bottom plate if the BH dimension is less than end distance dimension.
 - 6) Deflections are derived from static, monotonic load tests of devices connected to DF wood members and consider both the deflection of the holdown and fastener slippage.
 - 7) The designer shall consider the effect of compression, bearing, tension, and combined bending due to device eccentricity when applicable.
 - 8) The TD/TDX may be elevated off the sill which may increase deflection. Reference page 72 for more information.
- New products or updated product information are designated in **blue font**.

Corrosion Finish Key ■ Stainless Steel ■ Gold Coat ■ HDG ■ Triple Zinc

Secures multi-ply studs or posts to mudsills or foundation. Nail fastening makes for a convenient connection to studs or posts in cramped retrofit installations.

Materials: See chart

Finish: G90 galvanizing

Codes: See chart for code references

Installation:

- Use all specified fasteners to attach the strap portion of the connector to the side of stud, post, joist, purlin, or beam. Secure the base to the concrete or masonry wall with specified anchor bolt. A design professional shall specify the type, length, and embedment of the anchor bolt.
- HTT45 Max – Fill all round and diamond nail holes.
- Washers are not required on transfer plates that fit over the anchor bolt.
- Tighten anchor bolt nuts finger tight to base plus 1/3 to 1/2 additional turns with a wrench.
- LL930 (#9 X 2-7/8" long) LumberLok Screws are included with HTT45KT.



Typical HTT16 installation



Typical HTT45 max installation



HTT16



HTT45

MiTek Stock No.	Ref. No.	Steel Gauge	Dimensions (in)				Nail Spacing	Fastener Schedule				DF/SP Allowable Tension Loads (Lbs.) ¹		Code Ref.	
			W	L	D	CL		Min/Max	Anchor Bolt ³		Strap ^{2,3,7}		160%		Δ (in) ^{4,5}
									Qty	Dia.	Qty	Type			
HTT16	HTT4	10	2-1/2	16	2	1-3/8	1-3/4	--	1	5/8	18	10d	3610	0.142	IBC, FL, LA
HTT45	HTT4, HTT5	10	2-1/2	16	2	1-3/8	1-3/4	Min	1	5/8	18	10d	4215	0.115	
								Max	1	5/8	26	16d x 2-1/2	4160	0.108	
HTT45KT ⁶	HTT5KT	10	2-1/2	16	2	1-3/8	1-3/4	--	1	5/8	26	LL930	5795	0.101	
													5005		

- 1) Allowable loads have been increased 60% for wind or seismic loads; no further increase shall be permitted.
- 2) 16d sinkers may be substituted for the specified 10d common nails with no load reduction.
16d common nails may be substituted for the specified 16d x 2-1/2" nails with no load reduction.
- 3) The designer must specify anchor bolt type, length and embedment depth.
- 4) Deflections are derived from static, monotonic load tests of devices connected to DF wood members with specified fasteners.
- 5) HTT holdowns raised off of the sill plate may have higher deflection values.
- 6) HTT45KT is sold as a kit and includes (1) HTT45 and (26) LL930 screws.
- 7) **NAILS:** 10d nails are 0.148" dia. x 3" long, 16d x 2-1/2" nails are 0.162" dia. x 2-1/2" long.

LTS series – The LTS19 is designed for nail-on installation to 2x joists or studs, and the LTS20B provides a nail or bolt fastening option. The LTS20B will accommodate wood I-Joists if 10d (0.148") x 1-1/2" nails are used instead of the specified 16d nails.

LTTI31 – An open web joist tension tie designed for use with masonry or concrete construction.

Materials: See chart

Finish: G90 galvanizing; LTS19-TZ – G-185 galvanizing

Codes: IBC, FL

Installation:

- Use all specified fasteners to attach the strap portion of the connector to the side of stud, post, joist, purlin, or beam. Secure the base to the concrete or masonry wall with specified anchor bolt. A design professional shall specify the type, length, and embedment of the anchor bolt.
- Washers are not required on transfer plates that fit over the anchor bolt.
- LTTI31 and LTS connectors must be mounted flush to the mudsill.
- Allowable loads are based on either nail or bolt fastening; nail and bolt values cannot be combined.
- Tighten anchor bolt nuts finger tight to base plus 1/3 to 1/2 additional turns with a wrench.
- Refer to MiTek's LTS19-TZ Deck Lateral Load Connector Technical Bulletin for deck rail reinforcement at MiTek-US.com.

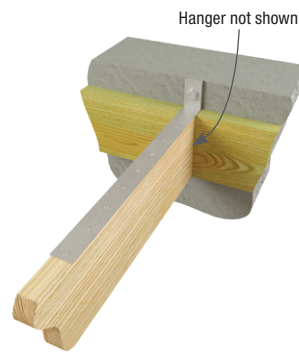

Typical LTS installation

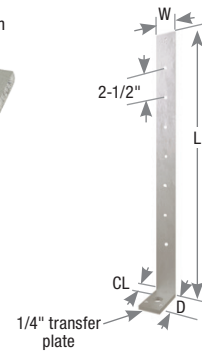

LTS19-TZ

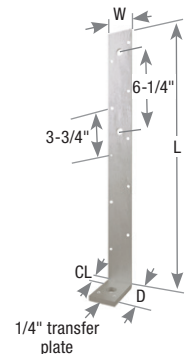

LTS20B

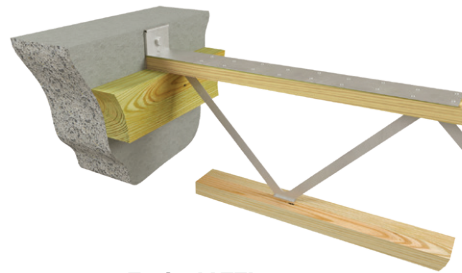

Typical LTTI31 installation

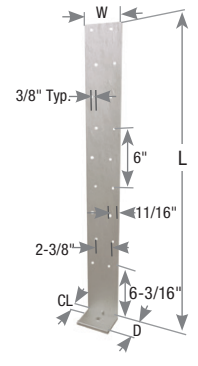

LTTI31

Holdowns

MiTek Stock No. ⁶	Ref. No.	Steel Gauge		Dimensions (in)				Nail Spacing	Fastener Schedule				DF/SP Allowable Tension Loads (Lbs.) ¹		Corrosion Finish	Code Ref.
		Strap	Plate	W	L	D	CL		Anchor Bolt ⁴	Strap ^{2,3,7}		160%	Δ (in) ⁵			
										Qty	Dia.			Qty		
LTTI31	LTTI31	18	3	3-3/4	31	2-5/8	1-3/8	3	1	5/8	18	10d x 1-1/2	2805	0.175		IBC, FL
LTS19-TZ	LTT19	16	3	1-3/4	22-1/4	3	1-1/2	2-1/2	1	3/4	8	10d HDG	1205	0.132		
LTS20B	LTT20B	12	3	2	20	3	1-1/2	3-3/4	1	3/4	10	10d x 1-1/2	1100	0.128		
											10	16d	1105	0.128		
											2	1/2 Bolt	1175	0.128		

1) Allowable loads have been increased 60% for wind or seismic loads; no further increase shall be permitted.
 2) LTS20B bolted installation requires a minimum 1-1/2" wood member thickness.
 3) 16d sinkers may be substituted for the specified 10d common nails with no load reduction.
 4) The designer must specify anchor bolt type, length and embedment depth.
 5) Deflections are derived from static, monotonic load tests of devices connected to DF wood members with specified fasteners.
 6) LTTI and LTS holdowns shall be installed tight to the sill plate.
 7) **NAILS:** 10d x 1-1/2 nails are 0.148" dia. x 1-1/2" long, 10d nails are 0.148" dia. x 3" long, 16d nails are 0.162" dia. x 3-1/2" long.

Corrosion Finish Key ■ Stainless Steel ■ Gold Coat ■ HDG ■ Triple Zinc

Allowable loads and deflection values for holdowns such as TD, PHD, TDX, HTT and UPHD are based on installation with the anchor bolt aligned directly below the centerline of the holdown. The maximum tolerances for anchor bolt offset are described below.

Designer should consider that installation of a holdown raised above the sill plate may result in higher deflections. These deflections are different for every installation and should be calculated by a certified designer.

Installation:

- Holdown installed at maximum of 2' above the bottom plate.
- Anchor bolt installed at maximum 2" away from the centerline of the holdown.
- Threaded rod angle must not exceed 5 degrees or a pitch of 1/12.
- A threaded coupler must be used at the anchor bolt connection capable of developing 125% of strength of the rod.

Alternate installations:

1. Install additional full-height member(s) to the existing stud(s) or post to reduce the horizontal distance between the anchor bolt and the vertical member(s).
 - Multi-ply studs/posts must be fastened together to act as a single unit. Holdown fasteners must not be considered to contribute to fastening multiple members together.
 - Added members shall be of equal or better wood species.
 - Designer must consider any effect of additional eccentricity introduced on the connection.
2. Using a threaded rod epoxied into place at the proper location in lieu of cast-in anchor bolts. These can be installed after the rough framing is completed.

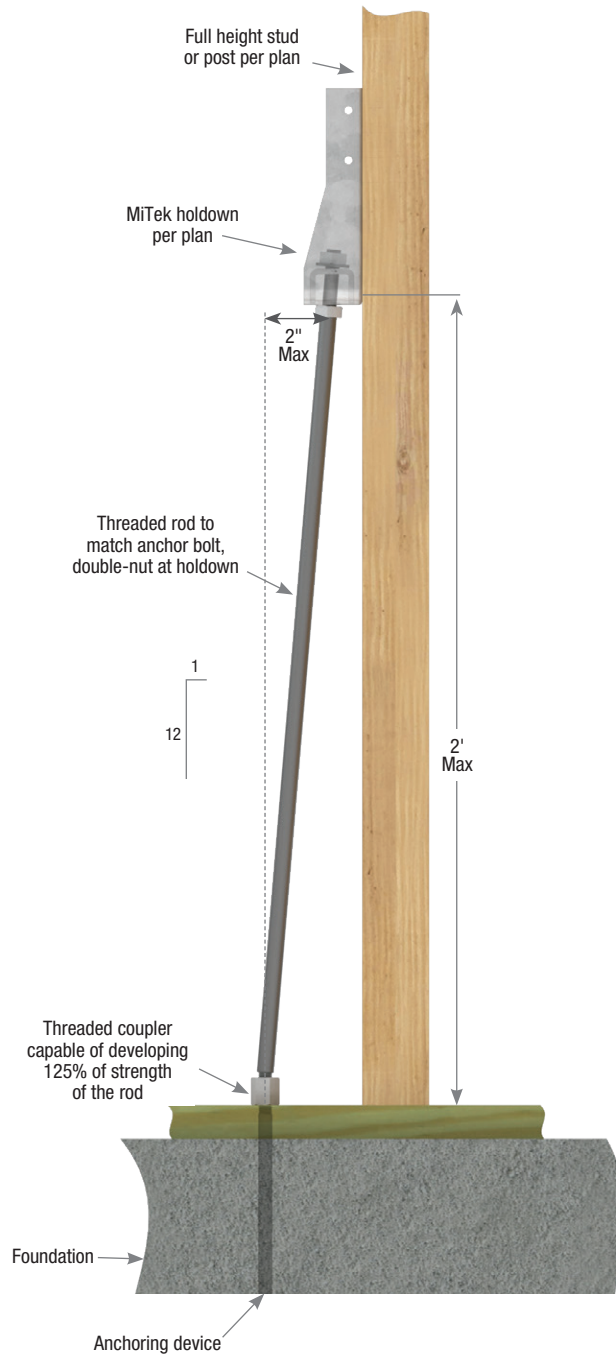

Copyright © 2022 MiTek Industries, Inc. All Rights Reserved

Foundation Straps offer an economical, one-piece method of achieving a continuous load path from a 2 x 8 or 2 x 14 dimensional rim joist through concrete block to foundation. All models require a 6" embedment into concrete footings.

Materials: 12 gauge

Finish: G90 galvanizing

Options: See chart for Corrosion Finish Options

Installation:

- Use all specified fasteners. See Product Notes, page 18.
- Allowable loads are based on either nail fastening or bolt fastening; nail and bolt values cannot be combined.
- Install by inserting product into footing's wet concrete. All models require a 6" embedment into concrete foundations. Courses of concrete block must be laid over connector. Notch mudsill at connector locations. Wrap strap over rim joist and fasten.
- Do not rely on these straps to secure concrete sections together between cold joints; take other measures to transfer the load. If there is a cold joint between block and foundation, the minimum embedment must be made into the foundation.
- Based on product embedment the exposed number of fastener holes may be reduced. Using fewer fasteners will reduce allowable loads. Reduce allowable loads by the code prescribed allowable load per fastener, for each fastener not installed.
- Allowable loads are based on a minimum concrete compressive strength of 2,500 psi at 28 days.

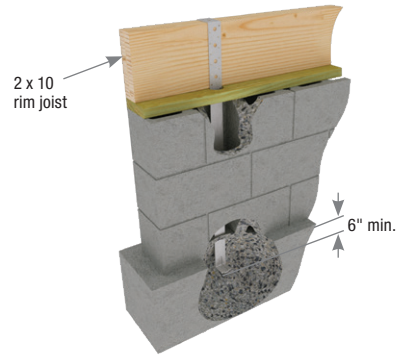

Typical TA rim joist to foundation installation



TA

MiTek Stock No.	Ref. No.	Steel Gauge	Dimensions (in)			DF/SP Allowable Loads (Lbs.)												Corrosion Finish	Code Ref.
						2 x 8			2 x 10			2 x 12			2 x 14				
			W	L	L1	Fastener Schedule ^{1,4}		Uplift ²	Fastener Schedule ^{1,4}		Uplift ²	Fastener Schedule ^{1,4}		Uplift ²	Fastener Schedule ^{1,4}		Uplift ²		
						Qty	Type		160%	Qty		Type	160%		Qty	Type			
TA51	PA51	12	2-1/16	48-1/4	17-5/8	2	1/2	1340	3	1/2	1950	4	1/2	2475	5	1/2	3230	Green	--
						8	16d x 2-1/2	1905	10	16d x 2-1/2	2385	14	16d x 2-1/2	3230	16	16d x 2-1/2	3230		
TA71	PA68	12	2-1/16	68-1/4	22-1/8	2	1/2	1340	3	1/2	1950	4	1/2	2475	5	1/2	3230	Green	--
						8	16d x 2-1/2	1905	10	16d x 2-1/2	2385	14	16d x 2-1/2	3230	16	16d x 2-1/2	3230		

1) Bolt values are for 3" thick rim joist loaded perpendicular to grain.
 2) Uplift loads have been increased 60% for wind and seismic loads; no further increase shall be permitted.
 3) Minimum of (9) 16d nails per strap is required to meet IRC R 404.1.5.
 4) **NAILS:** 16d x 2-1/2 nails are 0.162" dia. x 2-1/2" long.

Corrosion Finish Key ■ Stainless Steel ■ Gold Coat ■ HDG ■ Triple Zinc

The coined dimples below the embedment line allow for increased concrete bonding. These holdowns retain high uplift capacity even when installed at corners of foundation stemwalls. Ideal for use with built up 2x end posts.

RJ after the model indicates LSTAD or STAD for rim joist applications as in **STAD8RJ**. Rim joist models provide for a 17" clear span without the loss of strap nailing.

Materials: LSTAD-14 gauge; STAD-12 gauge

Finish: G90 galvanizing

Codes: IBC, FL, LA

Installation:

- Use all specified fasteners. See Product Notes, page 18. The bottom (2) nails are for form board attachment only and do not contribute to fastener schedule requirements.
- Embed holddown in concrete to the embedment line (bend line).
- See illustrations for requirements on rebar, edge distances, and clear spans.
- Bending the strap horizontally 90° to facilitate wall placement may cause concrete behind the embedded strap to break away at the top edge (spalling). If the spall is 1" or less from the top edge of the concrete, no load reduction is necessary. If the spall is between 1" and 4" the allowable load is 0.90 of the published chart load.
- When installing on lumber less than 3-1/2" wide, wood splitting may occur. To reduce splitting, use 10d (0.148" x 1-1/2" nails or fill every other hole with 16d (0.162" x 3-1/2") common nails. Reduce allowable loads per code requirements accordingly.
- These straps do not secure concrete sections together at cold joints; take other measures to transfer the load. If there is a cold joint between slab and foundation, the minimum embedment must be made into the foundation. Fastening opportunities may be reduced because the slab pour level may be higher than some nail holes. Using fewer fasteners will reduce allowable loads. Reduce allowable load by the code capacity for each fastener not installed.
- To achieve full table loads the minimum center-to-center spacing is twice the embedment depth (I_e) when resisting tension loads at the same time.
- Where fewer fasteners are used in the structural wood member, reduce loads according to the code.
- There may be an increase in the amount of deflection if the strap is installed on the outside of the sheathing, versus directly to the framing members.
- Strap may be bent one complete cycle to aid installation.
- For installation in severe corrosion environments, see Corrosion Information on pages 11-16.

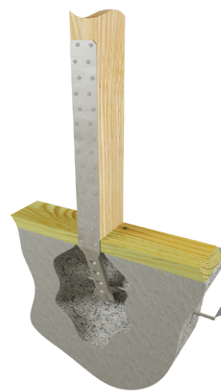

Typical STAD10 midwall installation

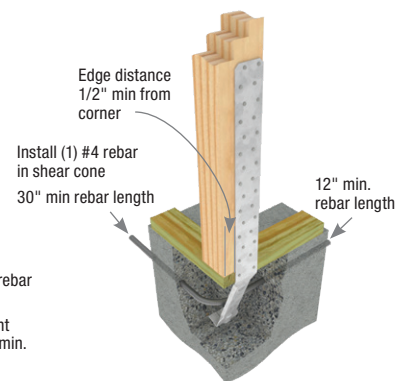

Typical STAD10 corner installation

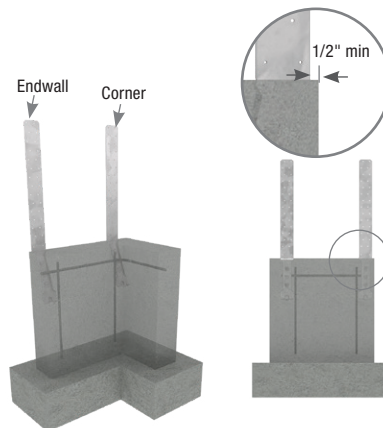

Typical STAD corner and endwall installation

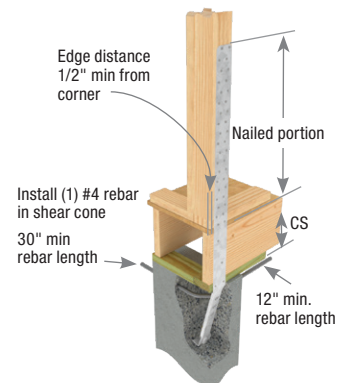

Typical STAD14RJ corner rim joist installation

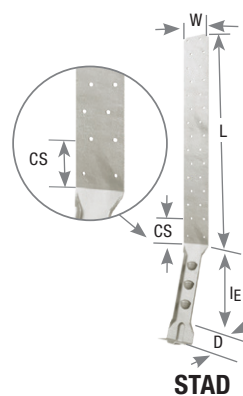

STAD

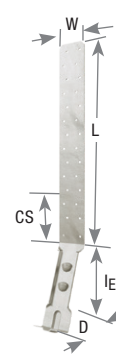

LSTAD

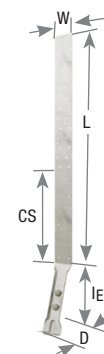

STAD_RJ

Continued on next page

MiTek Stock No.	Ref. No.	Ga.	Dimensions (in)					Concrete Stemwall Minimum Thickness (in)	Fastener Schedule ^{1,12}		Allowable Tension Loads (Lbs.) ^{6,7}						Code Ref.
			W	L	I _E	D	CS		Qty ⁸	Type	Uncracked			Cracked			
											Corner ³	Midwall ^{4,5}	Endwall ³	Corner ³	Midwall ^{4,5}	Endwall ³	
Wind and ASCE Seismic Design A & B - Allowable Tension Loads (Lbs.)																	
LSTAD8	LSTHD8	14	3	21-5/8	8	5	4-5/8	6	20	16d Sinker	2280	2950	--	1820	2950	--	IBC, FL, LA
LSTAD8RJ	LSTHD8RJ			35-1/8													
STAD8	--	12	3	21-5/8	8	5	4-5/8	6	22	16d Sinker	2265	3675	2175	1905	3175	1865	
STAD8RJ	--			35-1/8													
STAD10	STHD10	12	3	21-5/8	10	5	1-5/8	6	28	16d Sinker	3135	4675	2540	2540	4480	2550	
STAD10RJ	STHD10RJ			36													
STAD14	STHD14	12	3	32-1/8	14	5	4-5/8	6	30	16d Sinker	4745	5010	2910	4745	5010	2890	
STAD14RJ	STHD14RJ			39-5/8													
ASCE Seismic Design C-F - Allowable Tension Loads (Lbs.)																	
MiTek Stock No.	Ref. No.	Ga.	Dimensions (in)					Concrete Stemwall Minimum Thickness (in)	Fastener Schedule ^{1,12}		Allowable Tension Loads (Lbs.) ^{6,7}						
			W	L	I _E	D	CS		Qty ⁸	Type	Uncracked			Cracked			
											Corner ³	Midwall ^{4,5}	Endwall ³	Corner ³	Midwall ^{4,5}	Endwall ³	
LSTAD8	LSTHD8	14	3	21-5/8	8	5	4-5/8	6	20	16d Sinker	1995	3125	--	1595	2735	--	IBC, FL, LA
LSTAD8RJ	LSTHD8RJ			35-1/8													
STAD8	--	12	3	21-5/8	8	5	4-5/8	6	18	16d Sinker	1985	2945	1730	1665	2780	1635	
STAD8RJ	--			35-1/8													
STAD10	STHD10	12	3	21-5/8	10	5	1-5/8	6	24	16d Sinker	2740	4275	2435	2220	3920	2235	
STAD10RJ	STHD10RJ			36													
STAD14	STHD14	12	3	32-1/8	14	5	4-5/8	6	24	16d Sinker	3880	4185	2300	3880	4185	2300	
STAD14RJ	STHD14RJ			39-5/8													

Holdowns

- 1) Predrilled holes are not required.
- 2) Wood thickness shall be no less than 3" (2 - 2x members).
- 3) Corner and Endwall strap location implies that the distance from the wall corner or endwall end to the edge of the strap is no less than 1/2".
- 4) Midwall strap location implies that the minimum distance from the corner of the wall to the centerline of the strap is no less than 1.5 times the embedment depth (I_E).
- 5) For edge distances between 1/2" and 1.5 x I_E calculate loads using straight line interpolation.
- 6) Minimum anchor spacing for full capacity is 2 x I_E. For spacing less than that reduce capacity proportionally.
- 7) Allowable tension loads are for Doug-Fir, Southern Pine, Spruce-Pine-Fir and Hem Fir.
- 8) The strap should be fastened with nails starting from lowest pair of nail holes and working up towards the top of the strap. In many cases, not all nail holes are needed to be filled.
- 9) Minimum concrete strength f'c = 2,500 psi.
- 10) Minimum 1-#4 rebar shall be installed in the shear cone.
- 11) Deflection at highest allowable loads for installation over wood double studs are as follows:
 LSTAD8 = 0.025", STAD8 = 0.045", STAD10 = 0.051", STAD14 = 0.099".
 LSTAD8RJ = 0.032", STAD8RJ = 0.050", STAD10RJ = 0.058", STAD14RJ = 0.103".
- 12) **NAILS:** 16d sinkers are 0.148" dia. x 3-1/4" long. 10d common (0.148" dia. x 3" long) nails may be substituted with no load reduction.

Designed to anchor wood framing to poured concrete foundations.

Materials: See chart

Finish: G90 galvanizing

Codes: See chart for code references

Installation:

- Use all specified fasteners. See Product Notes, page 18.
- Bending the strap horizontally 90° to facilitate wall placement may cause concrete behind the embedded strap to break away at the top edge (spalling). If the spall is 1" or less from the top edge of the concrete, no load reduction is necessary. If the spall is between 1" and 4", the allowable load is 0.90 of the published chart load.
- When installing on lumber less than 3-1/2" wide, wood splitting may occur. To reduce splitting, use 10d (0.148") x 1-1/2" nails or fill every other hole with 16d (0.162" x 3-1/2") common nails. Reduce allowable loads in accordance with code requirements.
- Straps are to be installed at the edge of concrete. Install prior to pour by nailing to form. Drive temporary nails through lowest two nail holes into form. Concrete level should reach embedment line; minimum embedment depths are listed in chart.
- Do not rely on these straps to secure concrete sections together between cold joints; take other measures to transfer the load. If there is a cold joint between slab and foundation, the minimum embedment must be made into the foundation. Fastening opportunities may be reduced because the slab pour level may be higher than some nail holes. Using fewer fasteners will reduce allowable loads. Reduce allowable load by the code capacity for each fastener not installed.
- Allowable loads based on a minimum concrete compressive strength of 2,500 psi at 28 days, with one #4 horizontal rebar in the shear cone. Rebar should be a minimum length of 2x embedment depth plus 12" (see chart for exceptions in corner installations).
- Where fewer fasteners are used in the structural wood member, reduce loads according to the code.
- There may be an increase in the amount of deflection if the strap is installed on the outside of the sheathing, versus directly to the framing members.
- Strap may be bent one complete cycle to aid installation.
- For installation in severe corrosion environments, see Corrosion Information on pages 11-16.

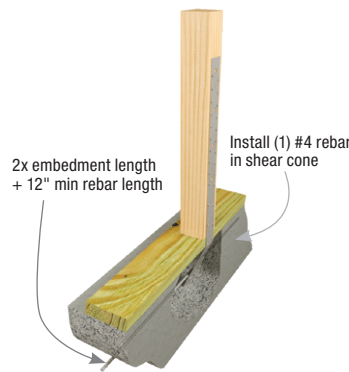

Typical HPAHD22 single pour midwall installation

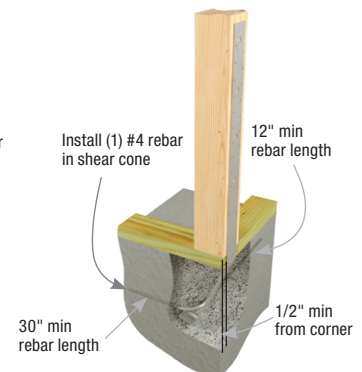

Typical HPAHD22 single pour corner and endwall installation

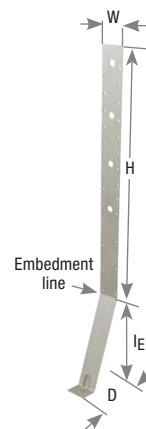

HPAHD

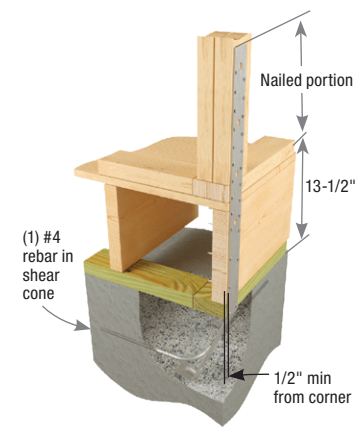

Typical HPAHD22 single pour rim joist corner installation

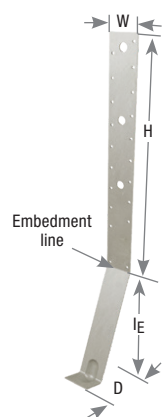

PAHD42

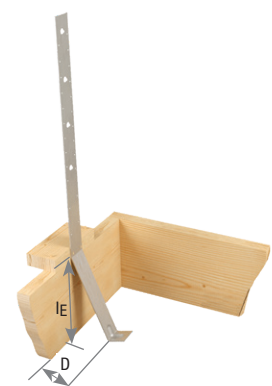

HPAHD22 form board installation

Copyright © 2022 MiTek Industries, Inc. All Rights Reserved

Holdowns

Continued on next page

HPAHD22 / PAHD42 Load Table

MiTek Stock No.	Ref. No.	Ga.	Dimensions (in)				Concrete Stemwall Minimum Thickness (in)	Fastener Schedule ¹		DF/SP Allowable Tension Loads (Lbs.) ⁵				Code Ref.
			W	L	I _E	D		Qty ⁶	Type ¹⁰	Uncracked		Cracked		
										Corner ²	Midwall ^{3,4}	Corner ²	Midwall ^{3,4}	
Wind and ASCE Seismic Design A & B														
HPAHD22	--	10	2-1/16	24-3/4	9-1/2	4-1/8	6	23	16d	3110	3265	2175	2285	IBC, FL, LA
PAHD42	--	12	2-1/16	16-5/8	8	5-3/4	6	15	16d	1155	2465	810	1725	
ASCE Seismic Design C-F														
MiTek Stock No.	Ref. No.	Ga.	Dimensions (in)				Concrete Stemwall Minimum Thickness (in)	Fastener Schedule ¹		DF/SP Allowable Tension Loads (Lbs.) ⁵				Code Ref.
			W	L	I _E	D		Qty ⁶	Type ¹⁰	Uncracked		Cracked		
										Corner ²	Midwall ^{3,4}	Corner ²	Midwall ^{3,4}	
HPAHD22	--	10	2-1/16	24-3/4	9-1/2	4-1/8	6	23	16d	2280	2855	1905	2000	IBC, FL, LA
PAHD42	--	12	2-1/16	16-5/8	8	5-3/4	6	15	16d	1010	1850	705	1510	

- 1) Predrilled holes are not required.
- 2) Corner strap location implies that the distance from the corner of the wall to the edge of the strap is no less than 1/2".
- 3) Midwall strap location implies that the minimum distance from the corner of the wall to the centerline of the strap is no less than 1.5 times the embedment depth (I_E).
- 4) For edge distances between 1/2" and 1.5 x I_E calculate loads using straight line interpolation.
- 5) Minimum anchor spacing for full capacity is 2 x I_E. For spacing less than that reduce capacity proportionally.
- 6) The strap should be fastened with nails starting from lowest pair of nail holes and working up towards the top of the strap.
In many cases, not all nail holes are needed to be filled.
- 7) Minimum concrete strength f'c = 2,500 psi.
- 8) Minimum 1-#4 rebar shall be installed in the shear cone.
- 9) Deflection at highest allowable loads for installation over wood double studs are as follows:
HPAHD22 = 0.118", PAHD42 = 0.095".
- 10) **NAILS:** 16d nails are 0.162" dia. x 3-1/2" long.

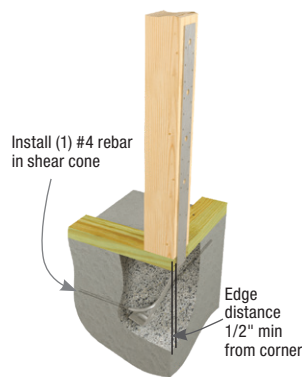

Typical HPAHD22-2P corner installation

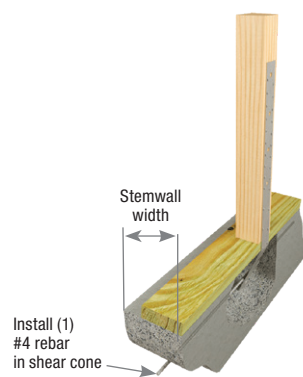

Typical HPAHD22-2P midwall installation

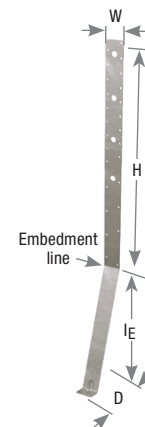

HPAHD22-2P

HPAHD22-2P Load Table

MiTek Stock No.	Steel Gauge	Dimensions (in)				Stemwall Width	Fastener Schedule ^{2,5}		DF/SP Allowable Tension Loads (Lbs.) ¹	Code Ref.
		W	H	I _E	D		Min Qty ⁴	Nail		
									160%	
MIDWALL INSTALLATION - 2,500 psi Concrete										
8" min from corner										
HPAHD22-2P	10	2-1/16	26-1/4	14	6-1/4	6/8	24	16d	5170	
CORNER INSTALLATION - 2,500 psi Concrete										
1/2" min from corner										
HPAHD22-2P	10	2-1/16	26-1/4	14	6-1/4	6/8	24	16d	4095	

- 1) Allowable loads have been increased 60% for wind or seismic loads; no further increase shall be permitted.
- 2) 16d sinkers (0.148" dia. x 3-1/4" long) or 10d common (0.148" dia. x 3" long) nails may be substituted for the specified 16d common nails provided the listed allowable loads are reduced 15%.
- 3) Minimum quantity of fasteners to be installed. Product may have additional nail holes not needed to meet published allowable load of product.
- 4) **NAILS:** 16d nails are 0.162" dia. x 3-1/2" long.

HPA series – For installation into poured concrete walls, foundations, or masonry. The HPA is the heavy-duty version of the PA anchor.

PA series – For installation into poured concrete or concrete block walls and foundations.

PAI series – For wood I-Joist applications. An expanded 3" on-center nail spacing reduces splitting along I-Joist flange.

Materials: HPA – 10 gauge; PA / PAI – 12 gauge

Finish: G90 galvanizing

Options: See chart for Corrosion Finish Options

Codes: IBC 1620.2.1

Installation:

- Use all specified fasteners. See Product Notes, page 18.
- Minimum concrete strength is 2,500 psi.
- The allowable loads for bolts are based on parallel to grain loading with a 3" minimum member thickness, except the HPA which requires a 3-1/2" thick wood member. Reduce load per code requirements when minimum member thickness is not achieved.
- Minimum concrete end/edge distance is 4" for PA / PAI series, and 6" for HPA series.
- Minimum CMU end/edge distance is 20".
- Designer may specify alternate fastening schedules. Refer to Nail Specification Table on page 23 for nail shear values. Load values shall not exceed published allowable loads.
- No anchor bolts are needed for achieving efficient stress transfer from framing to concrete walls or foundations.



Typical PA holdown installation

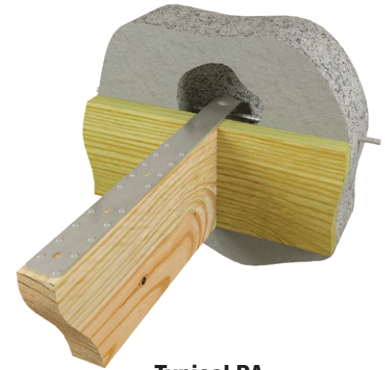

Typical PA purlin installation

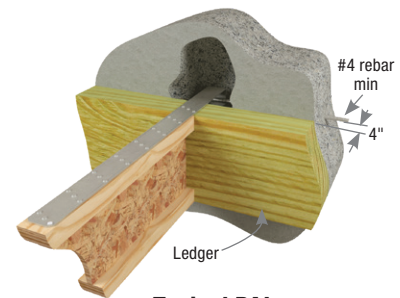

Typical PAI I-Joist purlin face installation

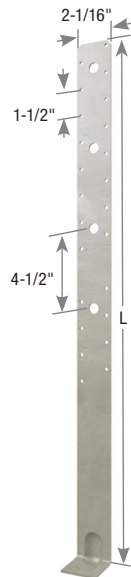

PA / HPA



PAI

Copyright © 2022 MiTek Industries, Inc. All Rights Reserved

Continued on next page

Wind and ASCE Seismic Design A & B																	
MiTek Stock No.	Ref. No.	L (in)	Min Embed Depth (in)		Ledger / Plate Size	Nails						Bolts					Code Ref.
			Concrete	Masonry		Fastener Schedule		Allowable Tension 160%				Fastener Schedule		Allowable Tension 160%			
						Min Qty ^{4,5,7,8}	Type	Uncracked Concrete	Cracked Concrete	Min Qty ^{4,5,7,8}	Type	Masonry	Min Qty ^{4,5,7,8}	Bolt Dia. (in)	Uncracked Concrete	Cracked Concrete	
PA18	PA18	18-1/2	4	6	None	12	16d	2975	2770	12	16d	2680	2	1/2	2240	2240	2240
					2x & 3x					11							2000
					4x					10							2480
PA23	PA23	23-3/4	4	6	None	15	16d	3720	2770	12	16d	2680	3	1/2	3360	2770	2680
					2x & 3x												2240
					4x												
PA28	PA28	29	4	6	None, 2x, 3x, 4x	15	16d	3720	2770	12	16d	2680	4	1/2	3960	2770	2680
PA35	PA35	35	4	6	None, 2x, 3x, 4x	15	16d	3720	2770	12	16d	2680	4	1/2	3960	2770	2680
HPA28	HPA28	29	6	8	None, 2x, 3x, 4x	21	16d	4715	3300	12	16d	2680	4	1/2	4545	3300	2680
HPA35	HPA35	35	6	8	None, 2x, 3x, 4x	23	16d	4715	3300	12	16d	2680	4	1/2	4545	3300	2680
PAI18	PAI18	18-1/2	4	6	None	12	10d x 1-1/2	2555	2555	12	10d x 1-1/2	2555	--	--	--	--	--
					2x & 3x					9		1915					
					4x					10		2130					
PAI23	PAI23	23-1/2	4	6	None	18	10d x 1-1/2	3830	2770	18	10d x 1-1/2	3830	--	--	--	--	--
					2x & 3x					15		3190					
					4x					15		3190					
PAI28	PAI28	28-1/2	4	6	None	21	10d x 1-1/2	3960	2770	22	10d x 1-1/2	4680	--	--	--	--	--
					2x & 3x					21		4470					
					4x					18		2680					
PAI35	PAI35	35-1/2	4	6	None	26	10d x 1-1/2	3960	2770	26	10d x 1-1/2	5535	--	--	--	--	--
					2x & 3x					25		5320					
					4x					23		2680					

ASCE Seismic Design C-F																	
MiTek Stock No.	Ref. No.	L (in)	Min Embed Depth (in)		Ledger / Plate Size	Nails						Bolts					Code Ref.
			Concrete	Masonry		Fastener Schedule		Allowable Tension 160%				Fastener Schedule		Allowable Tension 160%			
						Min Qty ^{4,5,7,8}	Type	Uncracked Concrete	Cracked Concrete	Min Qty ^{4,5,7,8}	Type	Masonry	Min Qty ^{4,5,7,8}	Bolt Dia. (in)	Uncracked Concrete	Cracked Concrete	
PA18	PA18	18-1/2	4	6	None	12	16d	2975	2425	12	16d	2680	2	1/2	2240	2240	2240
					2x & 3x					11		2000					
					4x					10		2480					
PA23	PA23	23-3/4	4	6	None	15	16d	3365	2425	12	16d	2680	3	1/2	3360	2425	2680
					2x & 3x							2240					
					4x												
PA28	PA28	29	4	6	None, 2x, 3x, 4x	15	16d	3365	2425	12	16d	2680	4	1/2	3365	2425	2680
PA35	PA35	35	4	6	None, 2x, 3x, 4x	15	16d	3365	2425	12	16d	2680	4	1/2	3365	2425	2680
HPA28	HPA28	29	6	8	None, 2x, 3x, 4x	21	16d	4125	2890	12	16d	2680	4	1/2	4125	2890	2680
HPA35	HPA35	35	6	8	None, 2x, 3x, 4x	23	16d	4125	2890	12	16d	2680	4	1/2	4125	2890	2680
PAI18	PAI18	18-1/2	4	6	None	12	10d x 1-1/2	2555	2425	12	10d x 1-1/2	2555	--	--	--	--	--
					2x & 3x					9		1915					
					4x					10		2130					
PAI23	PAI23	23-1/2	4	6	None	18	10d x 1-1/2	3365	2425	18	10d x 1-1/2	3830	--	--	--	--	--
					2x & 3x					15		3190					
					4x					15		2680					
PAI28	PAI28	28-1/2	4	6	None	21	10d x 1-1/2	3365	2425	22	10d x 1-1/2	4680	--	--	--	--	--
					2x & 3x					21		4470					
					4x					18		2680					
PAI35	PAI35	35-1/2	4	6	None	26	10d x 1-1/2	3365	2425	26	10d x 1-1/2	5535	--	--	--	--	--
					2x & 3x					25		5320					
					4x					23		2680					

1) Allowable loads have been increased 60% for wind or seismic loads; no further increase shall be permitted.
 2) Allowable loads for bolts are based on parallel-to-grain loading with 3" minimum member thickness, except HPA which requires a 3-1/2" thick wood member.
 3) Allowable loads are based on the use of either nails or bolts; nail and bolt values cannot be combined.
 4) 16d sinkers or 10d common nails may be substituted for the specified 16d common nails at 0.85 of the table loads.
 5) For alternate nail schedule and load values consult MiTek.
 6) Minimum quantity of fasteners to be installed. Product may have additional fastener holes not needed to meet published allowable load of product.
 7) NAILS: 10d x 1-1/2" nails are 0.148" dia. x 1-1/2" long, 16d nails are 0.162" dia. x 3-1/2" long.

Corrosion Finish Key
■ Stainless Steel ■ Gold Coat
■ HDG ■ Triple Zinc

Copyright © 2022 MiTek Industries, Inc. All Rights Reserved

Holdowns

CAPS & BASES



CAPS & BASES

82-105

Column Bases	88-91
Column Caps	99-105
Post Anchors	82-85, 92
Post Bases	86-87, 98
Post Caps	93-97



PA / PAE / PAU Post Anchors

Caps & Bases

Post Anchors are used to secure wood posts to concrete footings. These post anchors also provide moisture damage protection and feature a 1" stand-off plate to elevate wood posts above concrete surfaces as required by building code.

PAE – 2-sided post anchors with high uplift and bearing capacity

PA – High capacity utilizing 4-sided design

PAU – Higher uplift resistance and optional bolt fastening to post

Materials: See chart

Finish: G90 galvanizing, PA66ER-TZ - G-185 galvanizing

Options: See chart for Corrosion Finish Options

Codes: See chart for code references

IRC R317.1.4, IBC 2304.12.2.2,

IRC R407.3, IBC 2304.10.7

Installation:

- Use all specified fasteners. Install with supplied washer. See Product Notes, page 18.
- Anchor bolts and nails are not furnished.
- **Not recommended for fence posts or other unrestrained (not fixed or fastened at top) applications. These anchors are not designed to resist overturning (moment) loads.**
- **Anchor bolt installation** – place specified diameter anchor bolt at desired location with minimum 4" embedment into minimum 2,500 psi concrete. A minimum 2" edge distance from the outermost edge of the post base to the edge of the concrete is required to achieve allowable loads.
- **For cured concrete or retrofit installations** – use specified diameter threaded rod with MiTek's CIA-EA or CIA-GEL 7000-C adhesive epoxy, following installation instructions. Contact MiTek Engineering for further information on selecting the proper epoxy.



Typical PA44E installation



Typical PA installation

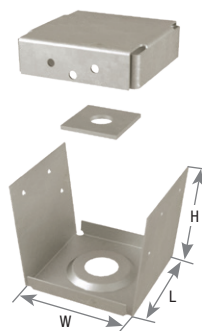

PAE

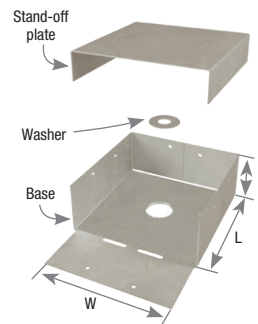

PA

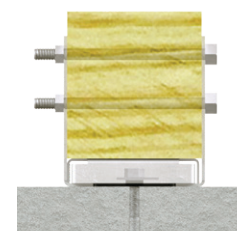

PAU cross-section

AVAILABLE IN
GOLD COAT

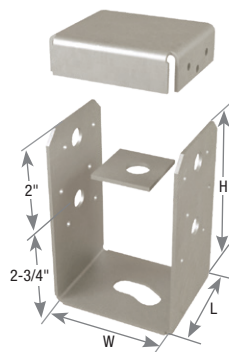

PAU

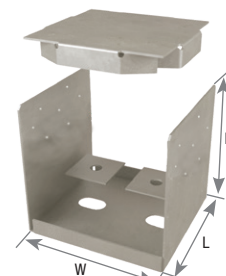

PAU88

Copyright © 2022 MiTek Industries, Inc. All Rights Reserved

Continued on next page

Caps & Bases

Post/ Column Size	MiTek Stock No.	Ref. No.	Steel Gauge		Dimensions (in)			Fastener Schedule ^{2,4}						DF/SP Allowable Loads (Lbs.) ³			Corrosion Finish	Code Ref.
			Base	Stand- off Plate	W	H	L	Anchor Bolt		Post				Bearing 100%	Uplift ¹			
								Qty	Dia. (in)	Nails		Bolts			160%	Bolts 160%		
										Qty	Type	Qty	Dia. (in)					
4 x 4	PA44	--	18	12	3-9/16	2-1/4	3-1/2	1	1/2	8	16d	--	--	4155	455	--		IBC, FL, LA
	PA44E	ABA44	18	16	3-9/16	3-1/2	3-1/2	1	1/2	6	16d	--	--	6775	1035	--		
	PAU44	ABU44	12	16	3-9/16	5-7/16	3	1	5/8	12	16d	2	1/2	6775	2535	2265		
4 x 4 Rough	PA44R	--	18	12	4-1/16	2-1/2	4	1	1/2	12	16d	--	--	4155	455	--		
4 x 6	PA46	--	18	12	3-9/16	2-1/4	5-1/2	1	1/2	14	16d	--	--	4155	455	--		IBC, FL, LA
	PA46E	ABA46	18	12	3-9/16	3-1/2	5-1/2	1	5/8	8	16d	--	--	6775	1035	--		
	PAU46	ABU46	10	12	3-9/16	6	5	1	5/8	12	16d	2	1/2	13815	2535	2265		
4 x 6 Rough	PA46R	--	18	10	4-1/16	3-1/2	6	1	1/2	14	16d	--	--	4155	455	--		
5 x 5 Rough	PA55R-TZ	--	16	12	5	3-5/8	5	1	1/2	8	16d HDG	--	--	4155	455	--		--
6 x 6	PA66	--	18	12	5-1/2	2-7/8	5-1/2	1	1/2	16	16d	--	--	5930	250	--		IBC, FL, LA
	PA66E	ABA66	14	12	5-1/2	3-1/2	5-1/2	1	5/8	8	16d	--	--	16005	1130	--		
	PAU66	ABU66	10	12	5-1/2	6	5	1	5/8	12	16d	2	1/2	16005	2455	2265		
6 x 6 Rough	PA66R	--	18	12	6-1/16	3-1/4	6-1/16	1	1/2	16	16d	--	--	5930	250	--		IBC, FL, LA
	PA66ER-TZ	ABA66R	14	12	6	3-1/4	5-1/2	1	5/8	8	16d HDG	--	--	16005	1130	--		
	PAU66R-TZ	ABU66RZ	10	12	6-1/16	5-3/4	5	1	5/8	12	16d HDG	2	1/2	16005	1475	1475		
8 x 8	PAU88	ABU88	12	12	7-1/2	7-3/16	7-1/16	2	5/8	14	16d	--	--	24900	3315	--		
8 x 8 Rough	PAU88R	ABU88R	12	12	8-1/16	6-15/16	7-1/16	2	5/8	14	16d	--	--	24900	3315	--		
10 x 10	PAU1010	ABU1010	12	16	9-1/2	7-3/16	9-1/2	2	5/8	14	16d	2	5/8	27095	1495	1495		
10 x 10 Rough	PAU1010R	--	12	16	10-1/16	7-3/16	10	2	5/8	14	16d	2	5/8	27095	1495	1495		
12 x 12	PAU1212	ABU1212	12	16	11-1/2	6-7/8	11-1/2	2	5/8	18	16d	2	5/8	64015	1180	1180		
12 x 12 Rough	PAU1212R	--	12	16	12-1/8	6-7/8	12-1/8	2	5/8	18	16d	2	5/8	64015	1180	1180		

Caps & Bases

Copyright © 2022 MiTek Industries, Inc. All Rights Reserved

- 1) Uplift loads have been increased 60% for wind or seismic loads; no further increase shall be permitted.
- 2) All bolts shall meet or exceed the specifications of ASTM A 307.
- 3) Allowable loads are based on the use of either nails or bolts; nail and bolt values cannot be combined.
- 4) **NAILS:** 16d nails are 0.162" dia. x 3-1/2" long.

Corrosion Finish Key ■ Stainless Steel ■ Gold Coat ■ HDG ■ Triple Zinc

RPB-TZ post base attaches 4x4 or larger wood posts to concrete or wood surfaces after the post is in place. Can be installed with 1 or 2 RPB-TZs (single or double). Post may also be installed on our CPB composite post base product which provides a 1" stand off as required in untreated wood installations. Installs with concrete screws, so no more mis-installed, mis-located anchor bolts!

Materials: 12 gauge

Finish: G-185 galvanizing

Installation:

- MiTek's WS structural wood screws and screw anchors are not included with RPB bases.
- **Not recommended for fence posts or other unrestrained (not fixed or fastened at top) applications. These anchors are not designed to resist overturning (moment) loads.**

Concrete Installation:

1. Place RPB-TZ over one corner of post flush to both concrete and post surfaces and mark hole locations in concrete. Place aside.
2. Drill holes for concrete screws using appropriate bit and hammer drill.
3. Place RPB-TZ in position and install with specified screw anchors as listed in table below.
4. Repeat for RPB-TZ on other side of post for double installations.

Wood-to-Wood Installation:

1. Place RPB-TZ over one corner of post flush to wood base and post surfaces.
2. Install all specified MiTek WS structural wood screws as listed in the table below.
3. Repeat for RPB-TZ on other side of post for double installations.

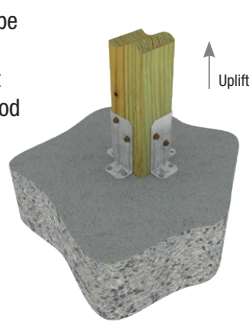

Typical double RPB-TZ concrete installation



Typical double RPB-TZ wood-to-wood installation

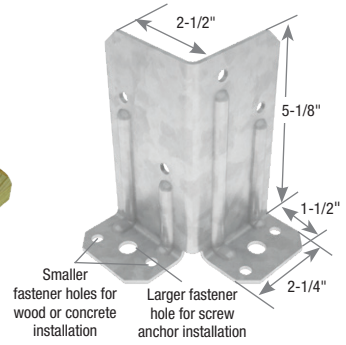

RPB-TZ

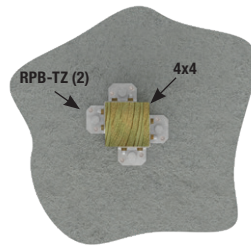

Typical double RPB-TZ concrete installation Min 2-1/2" from any concrete edge (Top view)

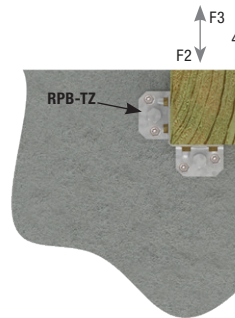

Typical single RPB-TZ installation at concrete corner, flush to edge (Top view)

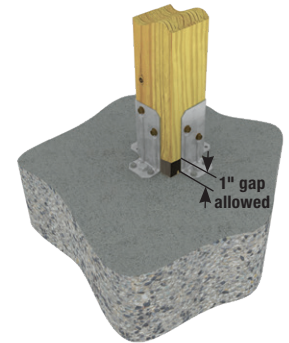

Typical double RPB-TZ installation with CPB composite post base (CPB ordered separately)

MiTek Stock No.	Ref. No.	Steel Gauge	Qty of RPBs	Fastener Schedule ^{10,11}				DF/SP Allowable Loads (Lbs.) ^{1,5}			Corrosion Finish	Code Ref.	
				Post		Base		Uplift 160%	F2 160%	F3 160%			
				Qty	Wood Screw	Qty	Type ^{2,3}						
RPB-TZ	RPBZ	12	Concrete Base with Post Flush to Corner⁶									--	
			1	4	WS3	2	3/8" x 2-1/2"	1525	710	495			
						4	Tapper+	735	655				
			1	4	WS15	2	3/8" x 2-1/2"	1470	710	495			
						4	Tapper+	735	655				
			Concrete Base with Post 2-1/2" from Concrete Edge^{4,6}										
			1	4	WS15 or WS3	2	3/8" x 2-1/2"	1470 ⁹	710	495			
						4	Tapper+	865	655				
			2 ⁴	8	WS15 or WS3	4	3/8" x 2-1/2"	2295	990	990			
						8	Tapper+	1735					
LVL Base/SP Base^{7,8}													
1	4	WS15 or WS3	4	WS15	1110	960	495						
			8		2220								

Corrosion Finish Key
 ■ Stainless Steel
 ■ Gold Coat
 ■ HDG
 ■ Triple Zinc

1) Allowable loads are for DF/SP 4x4, 6x6, or larger posts. For SPF/HF loads, multiply the allowable load by 0.86.
 2) Use DeWalt 3/8" x 2-1/2" Screw-Bolt™+ screw anchor; or equal, installed in accordance with manufacturer's specification. Screw anchors are not supplied.
 3) Use Powers 1/4" x 1-3/4" Tapper+ concrete screw anchor (not supplied); or equal, installed in accordance with manufacturer's specification.
 4) When installing connectors in pairs, the post must be a minimum of 2-1/2" from the edge of the concrete.
 5) Allowable loads have been increased 60% for wind and seismic loads; no further increase shall be permitted.

6) Concrete compressive strength shall be 2,500 psi or greater at 28 days.
 7) LVL framing base shall be at least 1-3/4" thick.
 8) SP framing base shall be at least 1-1/2" thick.
 9) Allowable uplift for single RPB-TZ using WS3 structural wood screws with Screw-Bolt™+ screw anchors for concrete base with post 2-1/2" from concrete edge is 1,525 lbs.
 10) MiTek's structural wood screws and DeWalt screw anchors should be used only in interior-dry and non-corrosive environments.
 11) Use MiTek's WS15-EXT or WS3-EXT structural wood screws when installing to treated wood.

WAS – A formed base providing a 1" stand-off with high bearing capacity.

WE – A formed, one-piece design. Includes embossing for additional lateral strength.

Materials: See chart

Finish: G90 galvanizing

Options: See chart for Corrosion Finish Options

Codes: IBC, FL, LA

IRC R317.1.4, IRC 2304.12.2.2,

IRC R407.3, IRC 2304.10.7

Installation:

- Use all specified fasteners. See Product Notes, page 18.
- Insert into wet concrete after the pour. For the **WE**, embed the anchor so that the base plate is flush with the surface of the concrete. For the **WAS**, embed the anchor until the concrete surface meets the bottom edge of the stand off base legs. This will provide a 1" stand-off where required.
- **Not recommended for fence posts or other unrestrained (not fixed or fastened at top) applications. These anchors are not designed to resist overturning (moment) loads.**

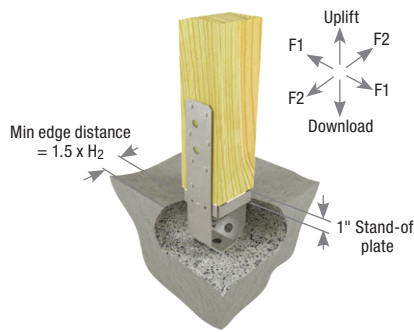

Typical WAS installation

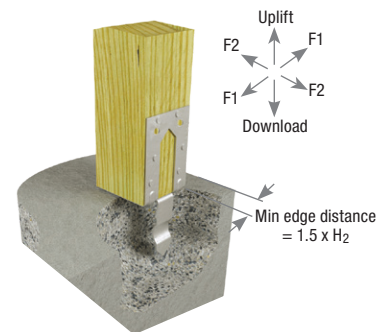

Typical WE installation

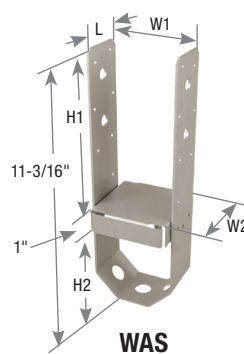

WAS

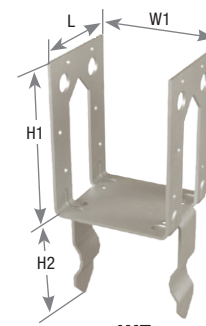

WE

Post Size	MiTek Stock No.	Ref. No.	Steel Gauge		Dimensions (in)					Fastener Schedule ^{5,6}		DF/SP Allowable Loads (Lbs.) ^{2,4}						Corrosion Finish	Code Ref.	
			Base	Strap	W1	W2	H1	H2 ³	L	Qty	Type	Download 100%	Uncracked Concrete			Cracked Concrete				
													Uplift ¹ 160%	F1 160%	F2 160%	Uplift ¹ 160%	F1 160%			F2 160%
ASCE Seismic Design A & B																				
4 x 4	WE44	PB44	12	12	3-1/2	--	4-3/4	3-3/8	3-1/4	12	16d	15335	1405	860	970	1245	600	680	IBC, FL, LA	
	WAS44	PBS44A	16	14	3-9/16	3-1/2	6-3/4	3-1/2	2-1/4	14	16d	6775	1430	860	970	1245	600	680		
4 x 4 Rough	WE44R	PB44R	12	12	4	--	5	3-5/8	3-3/8	12	16d	15335	3090	1365	1095	2165	955	770		
4 x 6	WE46	PB46	12	12	5-1/2	--	4-3/4	3-3/8	3-1/4	12	16d	24130	1405	860	970	1245	600	680		
	WAS46	PBS46	12	14	3-9/16	5-1/2	6-3/4	3-1/2	2-1/4	14	16d	13815	3090	1365	1095	2165	955	770		
4 x 6 Rough	WE46R	--	12	12	6	--	5	3-5/8	3-3/8	12	16d	24130	3075	1365	1095	2165	955	770		
6 x 6	WE66	PB66	12	12	5-1/2	--	5	3-5/8	5-3/8	12	16d	29565	1405	860	970	1245	600	680		
	WAS66	PBS66	12	12	5-1/2	5-1/2	6-3/4	5	2-1/4	14	16d	16005	3365	1955	1685	2505	1370	1685		
6 x 6 Rough	WE66R	PB66R	12	12	6	--	5	3-5/8	5-3/8	12	16d	29565	3575	1955	1685	2505	1370	1685		
ASCE Seismic Design C-F																				
4 x 4	WE44	PB44	12	12	3-1/2	--	4-3/4	3-3/8	3-1/4	12	16d	15335	1255	755	850	1090	525	595	IBC, FL, LA	
	WAS44	PBS44A	16	14	3-9/16	3-1/2	6-3/4	3-1/2	2-1/4	14	16d	6775	1255	755	850	1090	525	595		
4 x 4 Rough	WE44R	PB44R	12	12	4	--	5	3-5/8	3-3/8	12	16d	15335	2705	1195	960	1895	835	675		
4 x 6	WE46	PB46	12	12	5-1/2	--	4-3/4	3-3/8	3-1/4	12	16d	24130	2705	1195	960	1895	835	675		
	WAS46	PBS46	12	14	3-9/16	5-1/2	6-3/4	3-1/2	2-1/4	14	16d	13815	1255	755	850	1090	525	595		
4 x 6 Rough	WE46R	--	12	12	6	--	5	3-5/8	3-3/8	12	16d	24130	2705	1195	960	1895	835	675		
6 x 6	WE66	PB66	12	12	5-1/2	--	5	3-5/8	5-3/8	12	16d	29565	1255	755	850	1090	525	595		
	WAS66	PBS66	12	12	5-1/2	5-1/2	6-3/4	5	2-1/4	14	16d	16005	3135	1715	1685	2195	1200	1665		
6 x 6 Rough	WE66R	PB66R	12	12	6	--	5	3-5/8	5-3/8	12	16d	29565	3135	1715	1685	2195	1200	1665		

1) Uplift loads have been increased 60% for wind or seismic loads; no further increase shall be permitted.
 2) Allowable loads are based on the use of either nails or bolts; nail and bolt values cannot be combined.
 3) H2 is minimum embedment length of anchor into concrete.
 4) Minimum concrete strength f'c = 2,500 psi.
 5) All bolts shall meet or exceed the specifications of ASTM A 307.
 6) **NAILS:** 16d nails are 0.162" dia. x 3-1/2" long.

Corrosion Finish Key

- Stainless Steel
- Gold Coat
- HDG
- Triple Zinc

The EPB44T-TZ Elevated Post Base is an economical solution for supporting 4x4 posts at the minimum 1 inch above the concrete foundation as required by the building code. For applications where uplift loads are not present, the EPB44T-TZ can be installed directly into a hole predrilled in a pier block or concrete foundation as shown in Figure A below. To resist uplift loading, the EPB44T-TZ must be cast into concrete or epoxied into place as shown in Figure B below.

Materials: 12 gauge

Finish: G-185 galvanizing U-bracket; Hot-dip galvanized threaded rod, nuts, washers

Codes: IBC, FL, LA

Installation:

- Use all specified fasteners. See Product Notes, page 18.
- **Drilled Hole – No Uplift Resistance**
 - Drill 5/8" diameter hole into cured concrete 4" deep.
 - Insert threaded rod of EPB44T-TZ into hole and adjust nut to desired height.
 - Install 4x4 post and fasten with (8) 10d common nails.
- **Embedded In Concrete – Uplift Resistance Installation**
 - Adjust nut for desired height.
 - Insert threaded rod with nut and washer into wet concrete.
 - Provide temporary support to post base (if needed) to maintain vertical and horizontal position.
 - After concrete has cured, install 4x4 post and fasten with (8) 10d common nails.
- **Epoxied Into Place – Uplift Resistance Installation**
 - Drill 3/4" diameter hole into cured concrete 4" deep.
 - Clean hole as per MiTek's recommendations.
 - Adjust nut for desired height.
 - Fill the hole 3/4 full with MiTek Epoxy. Visit MiTek-US.com for proper installation procedures and injection of MiTek epoxy products.
 - Insert threaded rod with nut and washer into hole, pressing down until the washer is firmly seated on the concrete.
 - After epoxy has cured, install 4x4 post and fasten with (8) 10d common nails.
- **Not recommended for fence posts or other unrestrained (not fixed or fastened at top) applications. These anchors are not designed to resist overturning (moment) loads.**

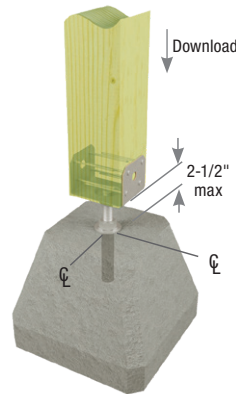
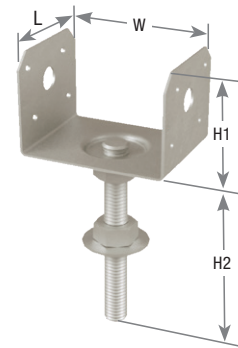

Figure A

Typical EPB44T-TZ pier block installation



EPB44T-TZ

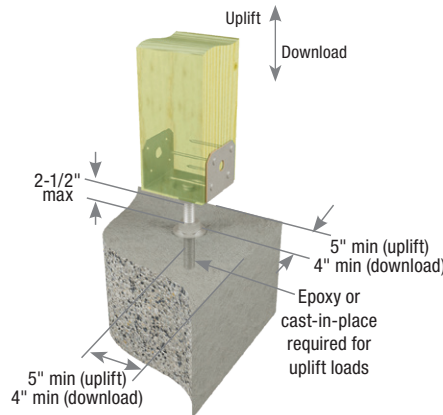

Figure B

Typical EPB44T-TZ installation with MiTek's Epoxy

MiTek Stock No.	Ref. No.	Steel Gauge (U-bracket)	Dimensions (in)				Wood Post Size	Fastener Schedule ⁸		Installation Type	DF/SP Allowable Loads (Lbs.) ^{1,5}			Corrosion Finish	Code Ref.
			W	L	H1	H2		Qty	Type		Uncracked Concrete ⁵		Cracked Concrete ⁵		
											ASCE Seismic Design A & B		ASCE Seismic Design C-F		
			Download 100% ⁴	Uplift 160% ^{2,3}	Download 100% ⁴										
EPB44T-TZ	--	12	3-9/16	2-7/8	2-7/16	4-7/8	4x4	8	10d	Pier Block ⁶	5525	--	5525	G	IBC, FL, LA
									Embedded	5525	790	5525			
									Epoxy ⁷	5525	790	5525			

1) Allowable loads are based on a maximum distance of 2-1/2" between the concrete foundation and the bottom of the post base.
 2) Uplift loads have been increased 60% for wind and seismic loads; no further increase shall be permitted.
 3) Uplift capacity requires the post base to be cast-in-place or epoxy post-installed in a concrete member capable of resisting the upward force.
 4) Download is based on the bearing of the wood in the post base and the bearing of the washer on the concrete.
 5) Minimum concrete strength f'c = 2,500 psi.
 6) Pier Block installation, drill a 5/8" diameter hole a minimum of 4" deep.
 7) Epoxy installation, drill a 3/4" diameter hole a minimum of 4" deep. Follow published epoxy installation instructions available at MiTek-US.com.
 8) **NAILS:** 10d nails are 0.148" dia. x 3" long.

Corrosion Finish Key ■ Stainless Steel ■ Gold Coat ■ HDG ■ Triple Zinc

These post bases allow installers to pre-align posts and preset post heights above concrete floors or footings. By eliminating post-to-concrete contact, moisture damage is reduced. Elevated post bases are ideal for building carports, decks or porches. All series feature convenient nail fastening to post.

Materials: See chart

Finish: EPB – Primer;
EBG44-TZ – G-185 galvanizing;
EPBH – Hot-dip galvanized

Options: See chart for Corrosion Finish Options

Codes: See chart for code references
IRC R317.1.4, IBC 2304.11.2.7, IRC R407.3, IBC 2304.9.7.

Installation:

- Use all specified fasteners. See Product Notes, page 18.
- **Not recommended for fence post or other fixed post applications. These anchors are not designed to resist overturning (moment) loads.**

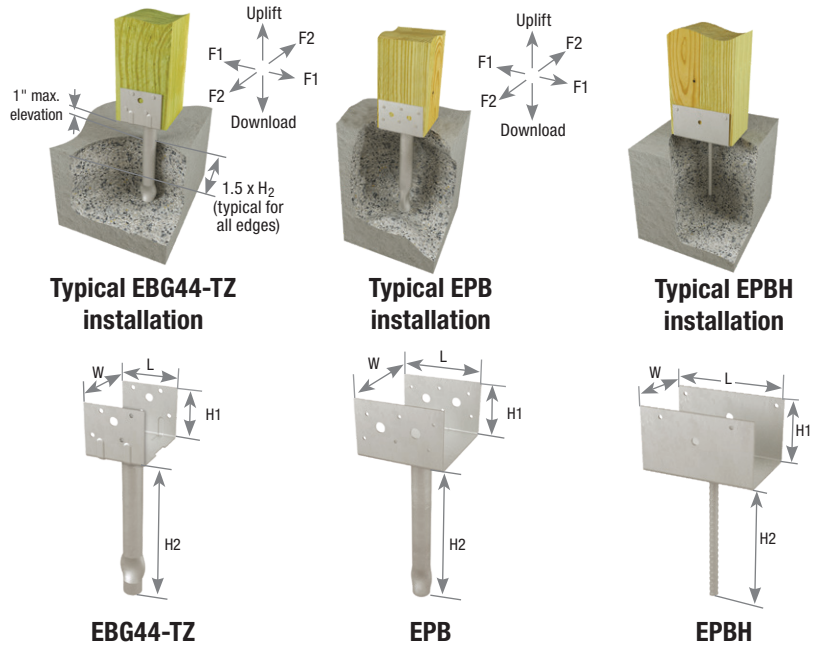

Post Size	MiTek Stock No.	Ref. No.	Steel Gauge		Dimensions (in)				Fastener Schedule ⁴		DF/SP Allowable Loads (Lbs.) ³						Corrosion Finish	Code Ref.	
			Base	Tube	W	L	H1	H2	Qty	Nail	Download 100%	Uncracked Concrete			Cracked Concrete				
												Uplift ² 160%	F1 ¹ 160%	F2 ¹ 160%	Uplift ² 160%	F1 ¹ 160%			F2 ¹ 160%
Wind and ASCE Seismic Design A & B																			
4 x 4	EBG44-TZ	EPB44A	14	16	3-9/16	2-3/4	2-3/8	7-1/2	8	16d HDG	4615	1085	1440	1295	800	1010	905	IBC, FL, LA	
	EPB4408	EPB44, EPB44-12	12	--	3-9/16	3	3	8	8	16d	3045	1110	1440	1295	775	1010	905	--	
	EPBH44	--	12	--	3-1/2	3-3/8	2-3/4	7	4	16d HDG	2485	990	990	975	990	845	845	--	
4 x 6	EPB4608	EPB46, EPB46-12	12	--	3-9/16	5	3	8	12	16d	3045	1110	1440	1295	775	1010	905	IBC, FL, LA	
4 x 6 Rough	EPBH46R	--	12	--	4-1/8	5-3/8	3	7	4	16d HDG	4615	990	990	975	990	845	845	--	
6 x 6	EPB6608	EPB66, EPB66-12	12	--	5-9/16	5	3-3/16	8	12	16d	4665	1110	1440	1295	775	1010	905	IBC, FL, LA	
	EPBH66	--	12	--	5-1/2	5-3/8	3	7	4	16d HDG	4615	990	990	975	990	845	845	--	
6 x 6 Rough	EPBH66R	--	12	--	6-1/8	5-3/8	3	7	4	16d HDG	4615	990	990	975	990	845	845	--	
ASCE Seismic Design C-F																			
4 x 4	EBG44-TZ	EPB44A	14	16	3-9/16	2-3/4	2-3/8	7-1/2	8	16d HDG	4615	1000	1260	1135	700	885	795	IBC, FL, LA	
	EPB4408	EPB44, EPB44-12	12	--	3-9/16	3	3	8	8	16d	3045	970	1260	1135	680	885	795	--	
	EPBH44	--	12	--	3-1/2	3-3/8	2-3/4	7	4	16d HDG	2485	990	990	975	990	725	725	--	
4 x 6	EPB4608	EPB46, EPB46-12	12	--	3-9/16	5	3	8	12	16d	3045	970	1260	1135	680	885	795	IBC, FL, LA	
4 x 6 Rough	EPBH46R	--	12	--	4-1/8	5-3/8	3	7	4	16d HDG	4615	990	990	975	990	725	725	--	
6 x 6	EPB6608	EPB66, EPB66-12	12	--	5-9/16	5	3-3/16	8	12	16d	4665	970	1260	1135	680	885	795	IBC, FL, LA	
	EPBH66	--	12	--	5-1/2	5-3/8	3	7	4	16d HDG	4615	990	990	975	990	725	725	--	
6 x 6 Rough	EPBH66R	--	12	--	6-1/8	5-3/8	3	7	4	16d HDG	4615	990	990	975	990	725	725	--	

1) Lateral loads (F1 and F2) are for conditions where pipe extends no more than 1" above the concrete surface.
 2) Uplift Loads have been increased 60% for wind and seismic loads; no further increase shall be permitted.
 3) Concrete compressive strength shall be 2,500 psi or greater at 28 days.
 4) **NAILS:** 16d nails are 0.162" dia. x 3-1/2" long.

Corrosion Finish Key
 ■ Stainless Steel ■ Gold Coat
 ■ HDG ■ Triple Zinc

Copyright © 2022 MiTek Industries, Inc. All Rights Reserved

Caps & Bases

Provides high structural capacity and installs with bolts providing an architectural appearance.

Materials: See chart

Finish: KCB (5/8" bolt models) – G90 galvanizing;
KCB (3/4" bolt models) – Primer

Options: KCB models available in rough/full size.
See chart for Corrosion Finish Options

Codes: IRC R407.3, IBC 2304.10.7

Installation:

- Use all specified fasteners. See Product Notes, page 18.
- **Not recommended for fence posts or other unrestrained (not fixed or fastened at top) applications. These bases are not designed to resist overturning (moment) loads.**
- Maintain 3" minimum edge distance between post and edge of concrete.
- KCB column bases feature diamond holes for temporary nail fastening to facilitate drilling and bolting.
- Embed column base with bottom of base plate flush to concrete.

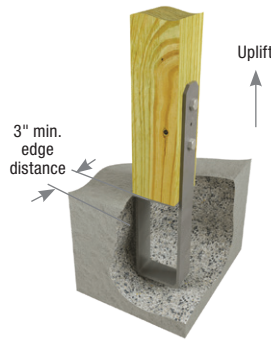

Typical KCB installation

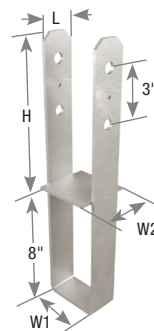

KCB

Column Size	MiTek Stock No.	Ref. No.	Steel Gauge		Dimensions (in)				Fastener Schedule ²		DF/SP Allowable Loads (Lbs.) ³				Corrosion Finish	Code Ref.
			Strap	Base	W1	W2	H	L	Qty	Type	Uncracked Concrete		Cracked Concrete			
											Uplift 160% ¹					
											ASCE Seismic Design A & B	ASCE Seismic Design C-F	ASCE Seismic Design A & B	ASCE Seismic Design C-F		
4 x 4	KCB44	CB44	7	7	3-9/16	3-9/16	8-7/8	2	2	5/8	5525	5100	4165	3570		
4 x 6	KCB46	CB46	7	7	3-9/16	5-1/2	8-7/8	2	2	5/8	5525	5100	4165	3570		
4 x 8	KCB48	CB48	7	7	3-9/16	7-1/2	8-7/8	2	2	5/8	5525	5100	4165	3570		
6 x 4	KCB64	CB64	7	7	5-1/2	3-1/2	8-7/8	3	2	5/8	6700	6465	5280	4525		
6 x 6	KCB66	CB66	7	7	5-1/2	5-1/2	8-7/8	3	2	5/8	6700	6465	5280	4525		
6 x 8	KCB68	CB68	7	7	5-1/2	7-1/2	8-7/8	3	2	5/8	6700	6465	5280	4525		
6 x 10	KCB610	CB610	7	7	5-1/2	9-1/2	8-7/8	3	2	5/8	6700	6465	5280	4525		
7 x 3-1/2	KCB74	CB7-1/8-4	3	7	7-1/8	3-1/2	9-3/4	3	2	3/4	6700	6465	5280	4525		--
7 x 5-1/2	KCB76	CB7-1/8-6	3	7	7-1/8	5-1/2	9-3/4	3	2	3/4	6700	6465	5280	4525		
7 x 7	KCB77	CB7-1/8-7	3	7	7-1/8	7-1/8	9-3/4	3	2	3/4	6700	6465	5280	4525		
8 x 6	KCB86	CB86	3	7	7-1/2	5-1/2	9-3/4	3	2	3/4	6700	6465	5280	4525		
8 x 8	KCB88	CB88	3	7	7-1/2	7-1/2	9-3/4	3	2	3/4	6700	6465	5280	4525		
10 x 10	KCB1010	CB1010	3	7	9-1/2	9-1/2	9-3/4	3	2	3/4	6700	6465	5280	4525		
10 x 12	KCB1012	CB1012	3	7	9-1/2	11-1/2	9-3/4	3	2	3/4	6700	6465	5280	4525		
12 x 12	KCB1212	CB1212	3	7	11-1/2	11-1/2	9-3/4	3	2	3/4	6700	6465	5280	4525		
Glulam Sizes																
5-1/8 glulam	KCB5	CB5-4.5, CB5-6	3	7	5-1/4	specify	9-3/4	3	2	3/4	6700	6465	5280	4525		
6-3/4 glulam	KCB7	CB7-6, CB7-7.5, CB7-9, CB7-10.5	3	7	6-7/8	specify	9-3/4	3	2	3/4	6700	6465	5280	4525		--
8-3/4 glulam	KCB9	CB9-6, CB9-7.5, CB9-9, CB9-10.5	3	7	8-7/8	specify	9-3/4	3	2	3/4	6700	6465	5280	4525		

1) Uplift Loads have been increased 60% for wind and seismic loads, no further increase shall be permitted.
2) All bolts shall meet or exceed the specifications of ASTM A 307.
3) Concrete compressive strength shall be 2,500 psi or greater at 28 days.

Corrosion Finish Key ■ Stainless Steel ■ Gold Coat ■ HDG ■ Triple Zinc

High capacity column base fastens to column with MiTek's WS structural wood screws.

Materials: 10 gauge

Finish: G90 galvanizing

Options: KCBQ models available in rough/full sizes

See chart for Corrosion Finish Options

Codes: IRC R407.3, IBC 2304.10.7

Installation:

- Use all specified fasteners. See Product Notes, page 18.
- MiTek's WS2 structural wood screws, 1/4" dia. x 2" long, are supplied with KCBQ Column Bases.
- **Not recommended for fence posts or other unrestrained (not fixed or fastened at top) applications. These bases are not designed to resist overturning (moment) loads.**
- Maintain 3" minimum edge distance between post and edge of concrete.
- Embed column base with bottom of base plate flush to concrete.

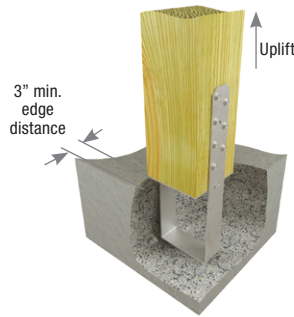

Typical KCBQ66 installation

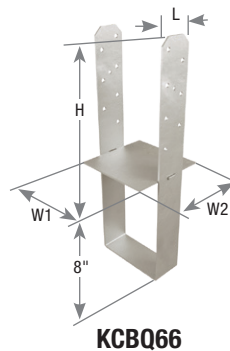

KCBQ66

Column Size	MiTek Stock No.	Ref. No.	Steel Gauge	Dimensions (in)				Fastener Schedule ²		DF/SP Allowable Loads (Lbs.) ³				Corrosion Finish	Code Ref.
				W1	W2 ⁴	H	L	Qty	Type	Uncracked Concrete		Cracked Concrete			
										Uplift 160% ¹		Uplift 160% ¹			
										ASCE Seismic Design A & B	ASCE Seismic Design C-F	ASCE Seismic Design A & B	ASCE Seismic Design C-F		
4 x 4	KCBQ44	--	10	3-9/16	3-1/2	8-3/4	2-1/4	14	WS2	6870	6530	5330	4570		
4 x 6	KCBQ46	--	10	3-9/16	5-1/2	8-3/4	2-1/4	14	WS2	6870	6530	5330	4570		
4 x 8	KCBQ48	--	10	3-9/16	7-1/2	8-3/4	2-1/4	14	WS2	6870	6530	5330	4570		
6 x 4	KCBQ64	--	10	5-1/2	3-1/2	8-3/4	2-1/4	14	WS2	6870	6530	5330	4570		
6 x 6	KCBQ66	--	10	5-1/2	5-1/2	8-3/4	2-1/4	14	WS2	6870	6530	5330	4570		
6 x 8	KCBQ68	--	10	5-1/2	7-1/2	8-3/4	2-1/4	14	WS2	6870	6530	5330	4570		
7-1/8 x 3-1/2	KCBQ71-4	--	10	7-1/8	3-1/2	8-3/4	2-1/4	14	WS2	6870	6530	5330	4570		
7-1/8 x 5-1/2	KCBQ71-6	--	10	7-1/8	5-1/2	8-3/4	2-1/4	14	WS2	6870	6530	5330	4570		--
7-1/8 x 7-1/8	KCBQ71-7	--	10	7-1/8	7-1/8	8-3/4	2-1/4	14	WS2	6870	6530	5330	4570		
8 x 6	KCBQ86	--	10	7-1/2	5-1/2	8-3/4	2-1/4	14	WS2	6870	6530	5330	4570		
8 x 8	KCBQ88	--	10	7-1/2	7-1/2	8-3/4	2-1/4	14	WS2	6870	6530	5330	4570		
10 x 10	KCBQ1010	--	10	9-1/2	9-1/2	8-3/4	2-1/4	14	WS2	6870	6530	5330	4570		
10 x 12	KCBQ1012	--	10	9-1/2	11-1/2	8-3/4	2-1/4	14	WS2	6870	6530	5330	4570		
12 x 12	KCBQ1212	--	10	11-1/2	11-1/2	8-3/4	2-1/4	14	WS2	6870	6530	5330	4570		
Glulam Sizes															
5-1/8 glulam	KCBQ5	--	10	5-1/4	Specify	8-3/4	2	14	WS2	6870	6530	5330	4570		
6-3/4 glulam	KCBQ7	--	10	6-7/8	Specify	8-3/4	2	14	WS2	6870	6530	5330	4570		--
8-3/4 glulam	KCBQ9	--	10	8-7/8	Specify	8-3/4	2	14	WS2	6870	6530	5330	4570		

1) Uplift loads have been increased 60% for wind or seismic loads; no further increase shall be permitted.
 2) MiTek's WS2 structural wood screws are 1/4" dia. x 2" long and are included with KCBQ Column Bases.
 3) Concrete compressive strength shall be 2,500 psi or greater at 28 days.
 4) "Specify" denotes the required width that must be specified at the time of ordering.

Corrosion Finish Key ■ Stainless Steel ■ Gold Coat ■ HDG ■ Triple Zinc

12 gauge base for carports, patios, or other residential framing.

Materials: 12 gauge

Finish: G90 galvanizing

Codes: IBC, FL, LA

IRC R407.3, IRC 2304.10.7

Installation:

- Use all specified fasteners. See Product Notes, page 18.
- **Not recommended for fence posts or other unrestrained (not fixed or fastened at top) applications. These bases are not designed to resist overturning (moment) loads.**
- Embed column base with bottom of base plate flush to concrete.

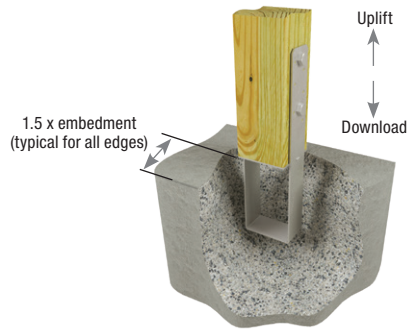

Typical CBE installation

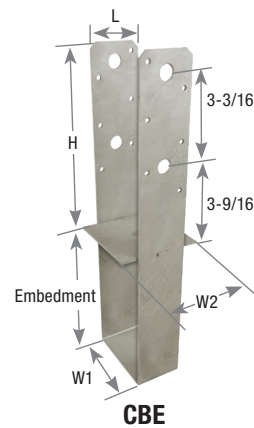

Column Size	MiTek Stock No.	Ref. No.	Steel Gauge	Dimensions (in)					Fastener Schedule ^{2,6}		DF/SP Allowable Loads (Lbs.) ^{3,4}					Code Ref.
				W1	W2	H	L	Embedment ⁵	Qty	Type	Uncracked Concrete		Cracked Concrete			
											Uplift 160% ¹		Uplift 160% ¹			
											ASCE Seismic Design A & B	ASCE Seismic Design C-F	ASCE Seismic Design A & B	ASCE Seismic Design C-F		
Download 100%	ASCE Seismic Design A & B	ASCE Seismic Design C-F	ASCE Seismic Design A & B	ASCE Seismic Design C-F												
4 x 4	CBE44	--	12	3-9/16	3-1/2	7-1/2	2	6-1/2	12	16d	16835	2975	2975	2975	2770	IBC, FL, LA
									2	1/2		4090	3605	3160		
4 x 6	CBE46	--	12	3-9/16	5-1/2	7-1/2	2	6-1/2	12	16d	26450	2975	2975	2975	2770	
									2	1/2		4090	3605	3160		
6 x 6	CBE66	--	12	5-1/2	5-1/2	7-1/2	2	5-1/2	12	16d	30250	2975	2975	2975	2770	
									2	1/2		4090	3605	3160		

1) Uplift Loads have been increased 60% for wind and seismic loads, no further increase shall be permitted.
 2) All bolts shall meet or exceed the specifications of ASTM A 307.
 3) Concrete compressive strength shall be 2,500 psi or greater at 28 days.
 4) Allowable loads are based on the use of either nails or bolts; nail and bolt values cannot be combined.
 5) CBE column base shall be embedded into concrete up to this depth.
 6) **NAILS:** 16d nails are 0.162" dia. x 3-1/2" long.

These column bases install using MiTek's WS2-EXT structural wood screws, reducing installation time and cost. Designed for high uplift in high wind or seismic applications. Includes a stand-off plate to protect the wood from ground contact moisture as required by building code.

Materials: See chart

Finish: G-185 galvanizing

Options: See chart for Corrosion Finish Options

Codes: IRC R317.1.4, IBC 2304.12.2.2, IRC R407.3, IBC 2304.10.7

Installation:

- Use all specified fasteners. See Product Notes, page 18.
- MiTek's WS2-EXT structural wood screws, 1/4" dia. x 2" long, are supplied with CBSQ Bases.
- Maintain 3" minimum edge distance between post and edge of concrete.
- Embed the column base until the concrete surface meets the bottom edge of the stand-off plate.
- **Not recommended for fence posts or other unrestrained (not fixed or fastened at top) applications. These bases are not designed to resist overturning (moment) loads.**

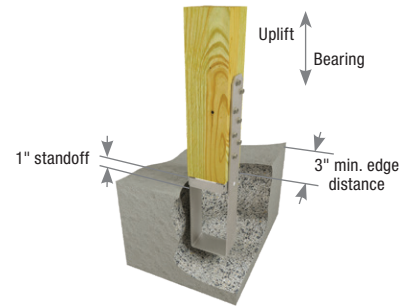

Typical CBSQ44-TZ installation

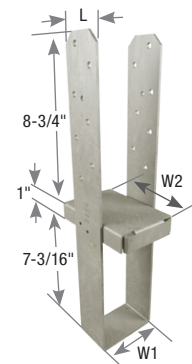

CBSQ46-TZ

Column Size	MiTek Stock No.	Ref. No.	Steel Gauge		Dimensions (in)				Fastener Schedule ²	Wood Screws	DF/SP Allowable Loads (Lbs.) ³				Corrosion	Finish	Code Ref.
			Strap	Base	W1	W2	L	Embed ⁴			Uncracked Concrete		Cracked Concrete				
			100%	Uplift 160% ¹	100%	Uplift 160% ¹											
ASCE Seismic Design A & B																	
4 x 4	CBSQ44-TZ	CBSQ44-SDS2	10	16	3-9/16	3-1/2	2-1/4	7-3/16	14	WS2-EXT	11950	5955	11950	4165			
4 x 6	CBSQ46-TZ	CBSQ46-SDS2	10	12	3-9/16	5-7/16	2-1/4	7-3/16	14	WS2-EXT	11955	5955	11955	4165			--
6 x 6	CBSQ66-TZ	CBSQ66-SDS2	10	12	5-1/2	5-7/16	3	7-3/16	14	WS2-EXT	11955	6870	11955	5280			
ASCE Seismic Design C-F																	
4 x 4	CBSQ44-TZ	CBSQ44-SDS2	10	16	3-9/16	3-1/2	2-1/4	7-3/16	14	WS2-EXT	11950	5100	11950	3570			
4 x 6	CBSQ46-TZ	CBSQ46-SDS2	10	12	3-9/16	5-7/16	2-1/4	7-3/16	14	WS2-EXT	11955	5100	11955	3570			--
6 x 6	CBSQ66-TZ	CBSQ66-SDS2	10	12	5-1/2	5-7/16	3	7-3/16	14	WS2-EXT	11955	6465	11955	4525			

1) Uplift loads have been increased 60% for wind and seismic loads, no further increase shall be permitted.
 2) MiTek's WS2-EXT structural wood screws are 1/4" dia. x 2" long and are included with CBSQ Column Bases.
 3) Concrete compressive strength shall be 2,500 psi or greater at 28 days.
 4) The CBSQ shall be embedded into concrete up to specified depth. The minimum side cover is 3".

Corrosion Finish Key ■ Stainless Steel ■ Gold Coat ■ HDG ■ Triple Zinc

Secures nominal sized posts to wood surfaces for light-duty applications.

Materials: 18 gauge

Finish: G90 galvanizing; D44-TZ & D46R-TZ - G-185 galvanizing

Options: See chart for Corrosion Finish Options

Codes: IBC, FL, LA

Installation:

- Use all specified fasteners. See Product Notes, page 18.
- **Not recommended for fence posts or other unrestrained (not fixed or fastened at top) applications. These anchors are not designed to resist overturning (moment) loads.**
- While D series post anchors offer lateral and uplift resistance, they are not recommended as a primary means of anchorage for posts in railings.

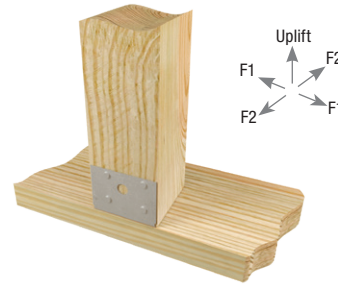

Typical D installation

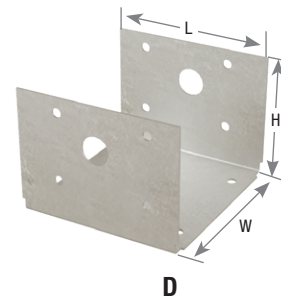

D

Post Size	MiTek Stock No.	Ref. No.	Steel Gauge	Dimensions (in)			Fastener Schedule ²				DF/SP Allowable Loads (Lbs.) ¹			S-P-F Allowable Loads (Lbs.) ¹			Corrosion Finish	Code Ref.
				W	H	L	Post		Beam		Uplift 160%	F1 160%	F2 160%	Uplift 160%	F1 160%	F2 160%		
							Qty	Type	Qty	Type								
4 x 4	D44-TZ	BC40, BC40Z	18	3-9/16	2-1/2	3-3/8	8	16d HDG	4	16d HDG	700	885	885	565	760	760	Green	IBC, FL, LA
4 x 4 Rough	D44R	BC40R	18	4	3	3-3/4	8	16d	4	16d	700	885	885	565	760	760	Green	
4 x 6	D46	BC460	18	3-9/16	3	5-3/8	10	16d	5	16d	700	995	1095	585	840	920	Green	
4 x 6 Rough	D46R-TZ	--	18	4	3	5-3/8	10	16d HDG	5	16d HDG	700	995	1095	585	840	920	Green	
6 x 6	D66	BC60	18	5-1/2	3	5-3/8	10	16d	5	16d	700	995	1095	585	840	920	Green	
6 x 6 Rough	D66R	BC60R	18	6	3	5-3/8	10	16d	5	16d	700	995	1095	585	840	920	Green	
8 x 8	D88	BC80	18	7-1/2	3	7-3/8	12	16d	5	16d	700	995	1095	585	840	920	Green	

1) Allowable loads have been increased 60% for wind or seismic loads; no further increase shall be permitted.

2) **NAILS:** 16d nails are 0.162" dia. x 3-1/2" long.

Corrosion Finish Key ■ Stainless Steel ■ Gold Coat ■ HDG ■ Triple Zinc

BC – One-piece design for double 2x's to a 4x post

BCS – One-piece design connects 2-ply or 3-ply beams to the tops of 4x4 or 6x6 post. Slant nailing reduces the amount of nails required

C – One-piece design

Materials: 18 gauge

Finish: G90 galvanizing;
BC400-TZ – G-185 galvanizing

Options: See chart for Corrosion Finish Options

Codes: See chart for code references

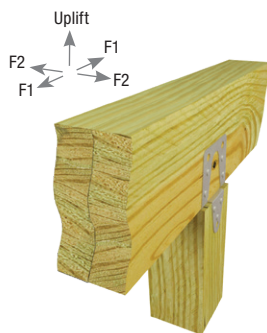

Typical BC400-TZ installation

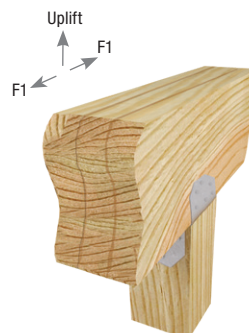

Typical BCS23-6 installation

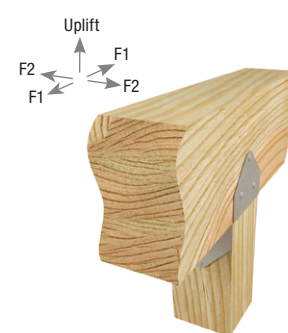

Typical C44 installation

Installation:

- Place post cap on top of post and fasten cap to post using specified nails.
- Place beam between top flanges of the cap and install all specified nails into beam.
- **BCS** – Slant nails must be installed through dimple holes at a 30° to 45° angle through the beam into the post to achieve listed loads. **Slant/double shear nails must be used to achieve listed load values.**

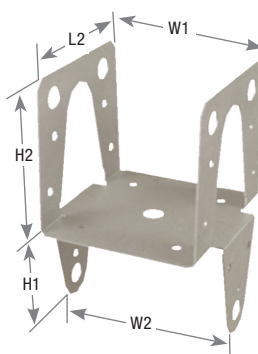

BC400-TZ

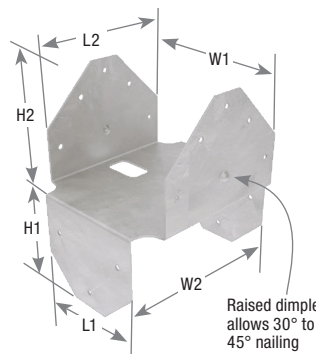

BCS23-6

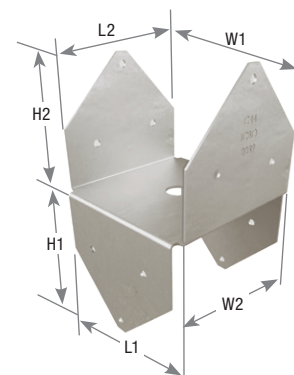

C44

Caps & Bases

Post Size	MiTek Stock No.	Ref. No.	Steel Gauge	Dimensions (in)						Fastener Schedule ^{2,3}				DF/SP Allowable Loads (Lbs.) ¹			Corrosion Finish	Code Ref.
				W1	W2	H1	H2	L1	L2	Post		Beam		Uplift 160%	F1 160%	F2 160%		
										Qty	Type	Qty	Type					
4 x 4	BCS22-4	BCS2-2/4	18	3-1/8	3-9/16	2-15/16	2-15/16	2-7/8	2-7/8	6	10d	8	10d	865	1065	--		
	BC400-TZ	--	18	3-1/8	3-9/16	2-3/8	3	3-1/2	3-5/16	10	10d x 1-1/2 HDG	8	10d x 1-1/2 HDG	615	780	580		--
	C44	BC4	18	3-9/16	3-9/16	2-7/8	2-7/8	3-1/4	3-1/4	6	16d	6	16d	925	1105	1105		
4 x 4 Rough	C44R	BC4R	18	4	4	2-5/8	2-5/8	3-1/4	3-1/4	8	16d	8	16d	925	1105	1105		IBC, FL, LA
4 x 6	C46	BC46	18	3-9/16	5-1/2	2-9/16	2-5/8	3-3/8	5-1/4	6	16d	10	16d	925	1105	1105		
4 x 6 Rough	C46R	--	18	4	6	2-3/4	2-3/4	3-1/4	5-1/4	8	16d	10	16d	925	1105	1105		
6 x 6	BCS23-6	BCS2-3/6	18	4-5/8	5-5/8	3	3-3/8	3-1/2	4-3/8	6	16d	12	16d	1120	1625	--		--
	C66	BC6	18	5-1/2	5-1/2	2-7/8	2-7/8	5-1/4	5-1/4	12	16d	12	16d	1195	2100	2100		
6 x 6 Rough	C66R	BC6R	18	6	6	2-13/16	2-13/16	5-1/4	5-1/4	12	16d	12	16d	955	2210	2210		IBC, FL, LA
8 x 8	C88	BC8	18	7-1/2	7-1/2	5	5	7-3/8	7-3/8	16	16d	16	16d	1195	2260	2260		

1) Allowable loads have been increased 60% for wind or seismic loads; no further increase shall be permitted.

2) BCS23-6: Substituting 16d x 2-1/2" nails for 16d common nails is not permitted for slant nailing.

3) **NAILS:** 10d x 1-1/2 nails are 0.148" dia. x 1-1/2" long, 10d nails are 0.148" dia. x 3" long, 16d nails are 0.162" dia. x 3-1/2" long.

Corrosion Finish Key ■ Stainless Steel ■ Gold Coat ■ HDG ■ Triple Zinc

PCM – Provides a positive connection for medium-duty, post-to-beam applications

EPCM – End column caps

Materials: See chart

Finish: G90 galvanizing

Options: See chart for Corrosion Finish Options

Codes: IBC, FL, LA

Installation:

- Use all specified fasteners. See Product Notes, page 18.
- PCM 16 gauge post caps should not be substituted for PCM 12 gauge post caps unless approved by the Engineer of Record.

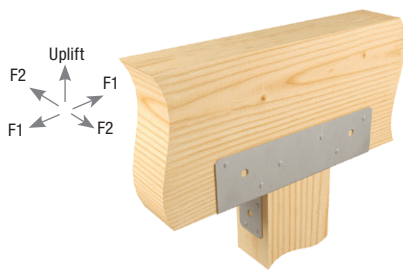

Typical PCM46 center cap installation

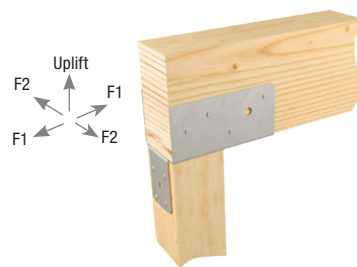

Typical EPCM end cap installation

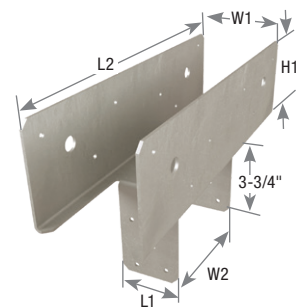

PCM

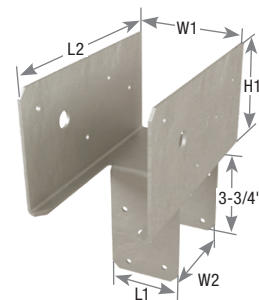

EPCM

Caps & Bases

MiTek Stock No.	Ref. No.	Steel Gauge	Beam	Post	Dimensions (in)					Fastener Schedule ²				DF/SP Allowable Loads (Lbs.)			Corrosion Finish	Code Ref.
					W1	W2	H1	L1	L2	Post		Beam		Uplift ¹ 160%	F1 160%	F2 160%		
										Qty	Type	Qty	Type					
Center Column Caps																		
PCM4416	--	16	4x	4x	3-9/16	3-9/16	3-9/16	2-7/16	11	8	16d	12	16d	970	1115	1335	IBC, FL, LA	
PCM44	--	12	4x	4x	3-9/16	3-9/16	3-9/16	2-7/16	11	8	16d	12	16d	1665	1350	1890		
PCM46	--	12	4x	6x	3-9/16	5-9/16	3-9/16	2-7/16	13	8	16d	12	16d	1665	1350	1890		
PCM4616	--	16	4x	6x	3-9/16	5-9/16	3-9/16	2-7/16	13	8	16d	12	16d	970	1115	1335		
PCM4816	--	16	4x	8x	3-9/16	7-9/16	3-9/16	2-7/16	15	8	16d	12	16d	970	1115	1335		
PCM48	--	12	4x	8x	3-9/16	7-9/16	3-9/16	2-7/16	15	8	16d	12	16d	1665	1350	1890		
PCM6416	--	16	6x	4x	5-1/2	3-9/16	3-1/2	3-13/16	11	8	16d	12	16d	950	1545	1675		
PCM64	--	12	6x	4x	5-1/2	3-9/16	3-1/2	3-13/16	11	8	16d	12	16d	1500	1875	1915		
PCM6616	--	16	6x	6x	5-1/2	5-9/16	3-1/2	3-13/16	13	8	16d	12	16d	950	1545	1675		
PCM66	--	12	6x	6x	5-1/2	5-9/16	3-1/2	3-13/16	13	8	16d	12	16d	1500	1875	1915		
PCM6816	--	16	6x	8x	5-1/2	7-9/16	3-1/2	3-13/16	15	8	16d	12	16d	950	1545	1675		
PCM68	--	12	6x	8x	5-1/2	7-9/16	3-1/2	3-13/16	15	8	16d	12	16d	1500	1875	1915		

1) Allowable loads have been increased 60% for wind or seismic loads; no further increase shall be permitted.

2) **NAILS:** 16d nails are 0.162" dia. x 3-1/2" long.

Corrosion Finish ■ Stainless Steel ■ Gold Coat ■ HDG ■ Triple Zinc

Copyright © 2022 MiTek Industries, Inc. All Rights Reserved

Continued on next page

MiTek Stock No.	Ref. No.	Steel Gauge	Beam	Post	Dimensions (in)					Fastener Schedule ²				DF/SP Allowable Loads (Lbs.)			Corrosion Finish	Code Ref.
					W1	W2	H1	L1	L2	Post		Beam		Uplift ¹ 160%	F1 160%	F2 160%		
										Qty	Type	Qty	Type					
Center Column Caps																		
PCM77	--	12	7-1/8	7-1/8	7-1/8	7-1/8	3-11/16	5-5/8	14-9/16	8	16d	12	16d	1500	1875	1915	IBC, FL, LA	
PCM8416	--	16	8x	4x	7-1/2	3-9/16	3-1/2	5-5/8	11	8	16d	12	16d	950	1545	1675		
PCM84	--	12	8x	4x	7-1/2	3-9/16	3-1/2	5-5/8	11	8	16d	12	16d	1500	1875	1915		
PCM8616	--	16	8x	6x	7-1/2	5-9/16	3-3/8	5-5/8	13	8	16d	12	16d	950	1545	1675		
PCM86	--	12	8x	6x	7-1/2	5-9/16	3-1/2	5-5/8	13	8	16d	12	16d	1500	1875	1915		
PCM8816	--	16	8x	8x	7-1/2	7-9/16	3-1/2	5-5/8	15	8	16d	12	16d	950	1545	1675		
PCM88	--	12	8x	8x	7-1/2	7-9/16	3-1/2	5-5/8	15	8	16d	12	16d	1500	1875	1915		
End Column Caps																		
EPCM4416	--	16	4x	4x	3-9/16	3-9/16	3-9/16	2-7/16	7-1/4	8	16d	8	16d	970	1115	1335	IBC, FL, LA	
EPCM44	--	12	4x	4x	3-9/16	3-9/16	3-9/16	2-7/16	7-1/4	8	16d	8	16d	1665	1350	1890		
EPCM46	--	12	4x	6x	3-9/16	5-9/16	3-9/16	2-7/16	9-1/4	8	16d	8	16d	1665	1350	1890		
EPCM4616	--	16	4x	6x	3-9/16	5-9/16	3-9/16	2-7/16	9-1/4	8	16d	8	16d	970	1115	1335		
EPCM4816	--	16	4x	8x	3-9/16	7-9/16	3-9/16	2-7/16	11-1/4	8	16d	8	16d	970	1115	1335		
EPCM48	--	12	4x	8x	3-9/16	7-9/16	3-9/16	2-7/16	11-1/4	8	16d	8	16d	1665	1350	1890		
EPCM6416	--	16	6x	4x	5-1/2	3-9/16	3-1/2	3-13/16	7-1/4	8	16d	8	16d	950	1545	1675		
EPCM64	--	12	6x	4x	5-1/2	3-9/16	3-1/2	3-13/16	7-1/4	8	16d	8	16d	1500	1875	1915		
EPCM6616	--	16	6x	6x	5-1/2	5-9/16	3-1/2	3-13/16	9-1/4	8	16d	8	16d	950	1545	1675		
EPCM66	--	12	6x	6x	5-1/2	5-9/16	3-1/2	3-13/16	9-1/4	8	16d	8	16d	1500	1875	1915		
EPCM6816	--	16	6x	8x	5-1/2	7-9/16	3-1/2	3-13/16	11-1/4	8	16d	8	16d	950	1545	1675		
EPCM68	--	12	6x	8x	5-1/2	7-9/16	3-1/2	3-13/16	11-1/4	8	16d	8	16d	1500	1875	1915		
EPCM77	--	12	7-1/8	7-1/8	7-1/8	7-1/8	3-11/16	5-5/8	10-13/16	8	16d	8	16d	1500	1875	1915		
EPCM8416	--	16	8x	4x	7-1/2	3-9/16	3-1/2	5-5/8	7-1/4	8	16d	8	16d	950	1545	1675		
EPCM84	--	12	8x	4x	7-1/2	3-9/16	3-1/2	5-5/8	7-1/4	8	16d	8	16d	1500	1875	1915		
EPCM8616	--	16	8x	6x	7-1/2	5-9/16	3-3/8	5-5/8	9-1/4	8	16d	8	16d	950	1545	1675		
EPCM86	--	12	8x	6x	7-1/2	5-9/16	3-1/2	5-5/8	9-1/4	8	16d	8	16d	1500	1875	1915		
EPCM8816	--	16	8x	8x	7-1/2	7-9/16	3-1/2	5-5/8	11-1/4	8	16d	8	16d	950	1545	1675		
EPCM88	--	12	8x	8x	7-1/2	7-9/16	3-1/2	5-5/8	11-1/4	8	16d	8	16d	1500	1875	1915		

Caps & Bases

Copyright © 2022 MiTek Industries, Inc. All Rights Reserved

1) Allowable loads have been increased 60% for wind or seismic loads; no further increase shall be permitted.
 2) **NAILS:** 16d nails are 0.162" dia. x 3-1/2" long.

Corrosion Finish ■ Stainless Steel ■ Gold Coat ■ HDG ■ Triple Zinc

PB – Two-piece design

PBES / PBS – Two-piece design with extended side plates and wrap around post design. Easy retrofit installations

Materials: 18 gauge

Finish: G90 galvanizing; PB44-6TZ &

PB66-6TZ – G-185 galvanizing

Options: See chart for Corrosion Finish Options

Codes: IBC, FL, LA

Installation:

- Use all specified fasteners. See Product Notes, page 18.
- These products are designed for single, solid-sawn beams with matching post width. Multi-ply beams must have same width as post. Use shims as required.
- **PB, PBES, PBS post caps are sold per piece and must be installed in pairs to achieve allowable loads.**

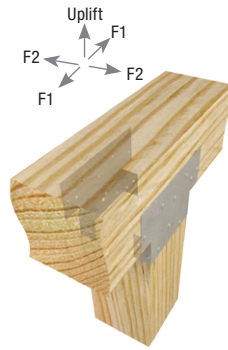

Typical PBS installation

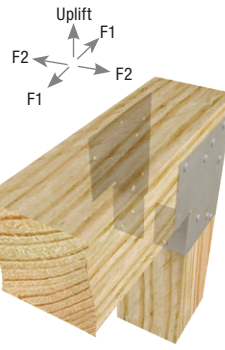

Typical PBES installation

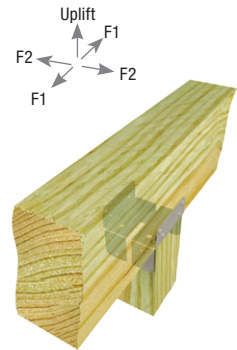

Typical PB-TZ installation

AVAILABLE IN
**GOLD
COAT**

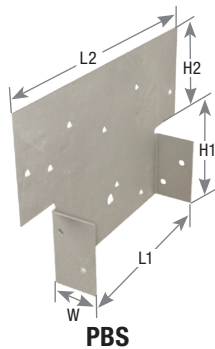

PBS

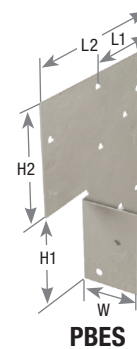

PBES

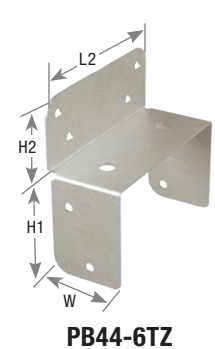

PB44-6TZ

Post Size	MiTek Stock No.	Ref. No.	Steel Gauge	Dimensions (in)					Fastener Schedule ^{2,3}				DF/SP Allowable Loads (Lbs.) ^{1,2}			Corrosion Finish	Code Ref.
				W	H1	H2	L1	L2	Post		Beam		Uplift 160%	F1 160%	F2 160%		
									Qty	Type	Qty	Type					
4 x 4	PB44-6TZ	LPC4Z	18	1-1/2	2-1/8	1-1/2	--	3-5/8	8	16d HDG	8	16d HDG	585	1760	1015	IBC, FL, LA	
	PBES44	LCE4	18	1-1/2	2-3/8	2-3/4	3-1/4	4-3/4	8	16d	8	16d	1765	920	810		
	PBS44-TZ	AC4	18	1-7/16	2-5/16	2-13/16	3-9/16	6-1/2	12	16d	12	16d	2650	1860	1110		
4 x 4 Rough	PBS44R	AC4R	18	1-1/2	2-5/16	2-3/16	4	7	8	16d	8	16d	1765	920	810	IBC, FL, LA	
6 x 6	PB66-6TZ	LPC6Z	18	1-1/2	2-1/2	3	--	5-9/16	8	16d HDG	8	16d HDG	585	1760	1015		
	PBES66	--	18	1-1/2	2-3/8	2-1/8	5-1/2	7	8	16d	8	16d	1670	1190	1235		
	PBS66-TZ	AC6	18	1-1/4	2-5/16	2-7/8	5-1/2	8	14	16d	12	16d	2015	1865	1300		
6 x 6 Rough	PBS66R-TZ	AC6R	18	1-1/4	2-5/16	2-3/16	6	8-1/2	10	16d	10	16d	1670	1190	1235		

1) Allowable loads have been increased 60% for wind or seismic loads; no further increase shall be permitted.

2) Allowable Loads and Fastener Schedules for a pair of post caps.

3) NAILS: 16d nails are 0.162" dia. x 3-1/2" long.

Corrosion Finish Key ■ Stainless Steel ■ Gold Coat ■ HDG ■ Triple Zinc

The PBC series is a one-piece connector designed to secure two mitered beams on a corner post while providing uplift capacity.

Materials: 18 gauge

Finish: G-185 galvanizing

Codes: IBC, FL, LA

Installation:

- Use all specified fasteners. See Product Notes, page 18.
- Install PBC on outside corner of post forming tabs to inner side of post.
- Assumes beam members are bevel cut at corner.

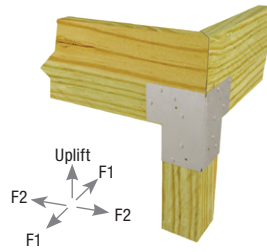

Typical PBC installation

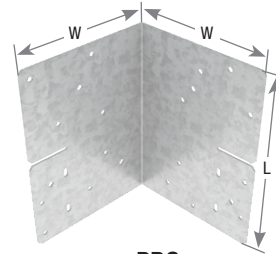

PBC

Post Size	MiTek Stock No.	Ref. No.	Steel Gauge	Dimensions (in)		Fastener Schedule ²				DF/SP			S-P-F			Corrosion Finish	Code Ref.
						Post		Beam		Allowable Loads (Lbs.) ¹			Allowable Loads (Lbs.) ¹				
				W	L	Qty	Type	Qty	Type	Uplift	F1	F2	Uplift	F1	F2		
4 x 4	PBC44-TZ	--	18	4-15/16	6-1/2	8	16d HDG	8	16d HDG	1765	1520	1520	1525	1275	1275	Green	IBC, FL, LA
6 x 6	PBC66-TZ	--	18	6-15/16	6-1/2	8	16d HDG	8	16d HDG	1765	1520	1520	1525	1275	1275		

1) Allowable loads have been increased 60% for wind or seismic loads; no further increase shall be permitted.

2) **NAILS:** 16d nails are 0.162" dia. x 3-1/2" long.

Corrosion Finish Key ■ Stainless Steel ■ Gold Coat ■ HDG ■ Triple Zinc

The CPB is made of corrosion resistant composite material compatible with preservative treated lumber. Provides code required 1" stand-off and can be used with rough lumber sizes.

Materials: High Strength composite

Codes: IRC R317.1.4, IBC 2304.12.2.2, IRC R407.3, IBC 2304.10.7

Installation:

- Attach base to post with (4) 10d HDG nails.
- Attach post to concrete using 1/2" diameter rod into concrete and extend into wood member.
- **Not recommended for fence posts or other unrestrained (not fixed or fastened at top) applications. These anchors are not designed to resist overturning (moment) loads.**



Typical CPB installation

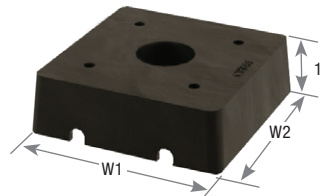

CPB

Post Size	MiTek Stock No.	Ref. No.	Dimensions (in)		Bottom Surface Bearing Area	Fastener Schedule ⁵		Post Base Allowable Capacity ^{1,2}	Concrete Design Bearing Strength ^{3,4}	Code Ref.
			W1	W2		Qty	Type			
4 x 4	CPB44	CPS4	3-1/4	3-1/4	2.2	4	10d HDG	5235	6545	PC
4 x 6	CPB46	CPS46	3-5/16	5-5/16	3.3	4	10d HDG	6810	9820	
5 x 5	CPB55	CPS5	4-1/8	4-1/8	3.0	4	10d HDG	6295	8925	
6 x 6	CPB66	CPS6	5-5/16	5-5/16	3.9	4	10d HDG	8570	11600	
8 x 8	CPB88	CPS7	7-1/4	7-1/4	6.4	4	10d HDG	12490	19040	

- 1) Loads shall not be increased for short-term loading.
- 2) Loads require a minimum 650 psi wood compressive strength.
- 3) Concrete Design Bearing Strength = $\phi (0.85 f'_c A_1)$ with $f'_c = 2,500$ psi. ACI 318-14, Section 22.8.3.
- 4) Design Bearing Strength has been increased assuming $(A_2 / A_1)^{0.5}$ per ACI 318-14, Section 22.8.3.
- 5) **NAILS:** 10d nails are 0.148" dia. x 3" long.

Lally Column Caps connect lally columns to wood beams.
Fits 3-1/2" and 4" diameter lally columns.

Materials: 12 gauge

Finish: Primer

Installation:

- Use all specified fasteners. See Product Notes, page 18.
- Fit KLCC onto lally column. Position wood beam in KLCC saddle and fasten.



Typical KLCC installation

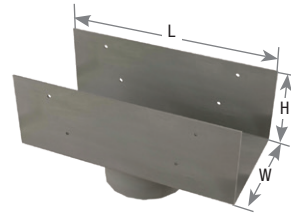

KLCC

MiTek Stock No.	Ref. No.	Steel Gauge	Dimensions (in)			Fastener Schedule			Column Outside Dia. (in)	DF/SP Allowable Loads (Lbs.) ^{1,2,3,4}	S-P-F Allowable Loads (Lbs.) ^{1,2,3,4}	LVL / PSL Allowable Loads (Lbs.) ^{1,2,3,4}	Code Ref.
			W	H	L	Girder	Nails ⁵						
							Qty	Type					
KLCC45-35	LCC4.5-3.5	12	4-5/8	4	11-1/2	Triple 2x10/12	8	16d	3-1/2	16000	16000	--	--
KLCC45-4	LCC4.5-4	12	4-5/8	4	11-1/2	Triple 2x10/12	8	16d	4	21000	21000	--	
KLCC6-35	LCC6-3.5	12	6-1/8	4	11-1/2	Quad 2x10/12	8	16d	3-1/2	16000	16000	--	
KLCC6-4	LCC6-4	12	6-1/8	4	11-1/2	Quad 2x10/12	8	16d	4	21000	21000	--	
KLCC35-35	LCC3.5-3.5	12	3-5/8	4	11-1/2	3.5 LVL / PSL	8	16d	3-1/2	--	--	16000	
KLCC35-4	LCC3.5-4	12	3-5/8	4	11-1/2	3.5 LVL / PSL	8	16d	4	--	--	21000	
KLCC525-35	LCC5.25-3.5	12	5-3/8	4	11-1/2	5.25 LVL / PSL	8	16d	3-1/2	--	--	16000	
KLCC525-4	LCC5.25-4	12	5-3/8	4	11-1/2	5.25 LVL / PSL	8	16d	4	--	--	21000	
KLCC7-35	LCC7-3.5	12	7-1/8	4	11-1/2	7 LVL / PSL	8	16d	3-1/2	--	--	16000	
KLCC7-4	LCC7-4	12	7-1/8	4	11-1/2	7 LVL / PSL	8	16d	4	--	--	21000	

1) Loads may not be increased for short-term loading.

2) Loads are for a continuous beam.

3) Allowable loads are determined using the lowest of the bearing loads. Use Fc-perp equal to 425 psi for SPF, 625 psi for DF and 700 psi for LVL/PSL, or the lally column capacity.

4) Spliced conditions must be detailed by the designer to transfer tension loads between spliced members by means other than the lally column. The splice condition load is 6750 lbs. per beam side and the lally cap must be evenly loaded.

5) **NAILS:** 16d nails are 0.162" dia. x 3-1/2" long.

Designed to be installed without the need to drill bolt holes, simplifying installation and maintaining the wood cross section. Installs with MiTek's WS structural wood screws offering high uplift capacity.

KCCQ – Standard column cap

KECCQ – End column version

Materials: See chart

Finish: Primer

Options: See chart for Corrosion Finish Options and Specialty Options on page 102.

Codes: IBC, FL, LA

Installation:

- Use all specified fasteners. See Product Notes, page 18.
- MiTek's WS3 structural wood screws, 1/4" dia. x 3" long, are supplied with Column Caps.
- Beams shall be designed to support the required loads. Beam shear may limit loads to less than listed loads for device. A design professional shall determine the adequacy of the post to resist published loads.



Typical KECCQ44 end cap installation



Typical KCCQ44 center cap installation

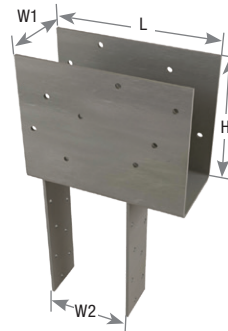

KECCQ44

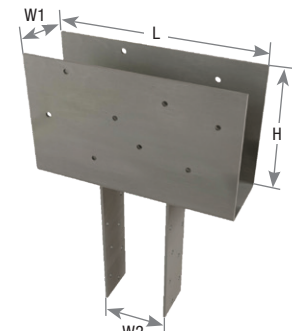

KCCQ44

MiTek Stock No.	Ref. No.	Steel Gauge	Dimensions (in)				Fastener Schedule ⁴				DF/SP Allowable Loads (Lbs.) ³		Corrosion Finish	Code Ref.
			W1	W2	H	L	Beam		Column or Post		Bearing ¹ 100%	Uplift ^{2,8} 160%		
							Qty	Type	Qty	Type				
Center Column Caps														
KCCQ325-4	CCQ3-4SDS2.5	7	3-1/4	3-5/8	6-1/2	11	16	WS3	14	WS3	21485	7065		
KCCQ325-6	CCQ3-6SDS2.5	7	3-1/4	5-1/2	6-1/2	11	16	WS3	14	WS3	21485	7065		
KCCQ44	CCQ44SDS2.5	7	3-5/8	3-5/8	6-1/2	11	16	WS3	14	WS3	24065	7065		
KCCQ45	--	7	3-5/8	5-3/8	6-1/2	11	16	WS3	14	WS3	24065	7065		
KCCQ46	CCQ46SDS2.5	7	3-5/8	5-1/2	6-1/2	11	16	WS3	14	WS3	24065	7065		
KCCQ47	--	7	3-5/8	7-1/8	6-1/2	11	16	WS3	14	WS3	24065	7065		
KCCQ47X	--	7	3-5/8	7-1/8	8	13	16	WS3	14	WS3	28440	7065		
KCCQ48	CCQ48SDS2.5	7	3-5/8	7-1/2	6-1/2	11	16	WS3	14	WS3	24065	7065		
KCCQ525-4	CCQ5-4SDS2.5	3	5-1/4	3-5/8	8	13	16	WS3	14	WS3	41640	7065		IBC, FL, LA
KCCQ525-6	CCQ5-6SDS2.5	3	5-1/4	5-1/2	8	13	16	WS3	14	WS3	41640	7065		
KCCQ525-8	CCQ5-8SDS2.5	3	5-1/4	7-1/2	8	13	16	WS3	14	WS3	41640	7065		
KCCQ57	--	7	5-3/8	7-1/8	6-1/2	11	16	WS3	14	WS3	36095	7065		
KCCQ64	CCQ64SDS2.5	7	5-1/2	3-5/8	6-1/2	11	16	WS3	14	WS3	37815	7065		
KCCQ66	CCQ66SDS2.5	7	5-1/2	5-1/2	6-1/2	11	16	WS3	14	WS3	37815	7065		
KCCQ67X	CCQ6-7.13SDS2.5	7	5-1/2	7-1/8	6-1/2	11	16	WS3	14	WS3	37815	7065		
KCCQ68	CCQ68SDS2.5	7	5-1/2	7-1/2	6-1/2	11	16	WS3	14	WS3	37815	7065		
KCCQ74	CCQ74SDS2.5	3	6-7/8	3-5/8	6-1/2	11	16	WS3	14	WS3	46405	7065		
KCCQ76	CCQ76SDS2.5	3	6-7/8	5-1/2	6-1/2	11	16	WS3	14	WS3	46405	7065		
KCCQ77	CCQ77SDS2.5	3	6-7/8	6-7/8	6-1/2	11	16	WS3	14	WS3	46405	7065		
KCCQ78	CCQ78SDS2.5	3	6-7/8	7-1/2	6-1/2	11	16	WS3	14	WS3	46405	7065		

- 1) Bearing loads are based on 625 psi perpendicular to grain loading; no further increase for duration of load is permitted.
- 2) Uplift loads have been increased 60% for wind or seismic loads; no further increase shall be permitted.
- 3) Allowable loads are based on lumber with a specific gravity of 0.50 and a moisture content of 19% or less.
- 4) MiTek WS3 structural wood screws are 1/4" dia. x 3" long and are included with KCCQ and KECCQ column caps.
- 5) Beams shall be designed to support the required loads. Beam shear may limit loads to less than listed loads for device.
- 6) The designer shall check post for required loads.
- 7) Spliced conditions must be detailed by the specifier to transfer tension loads between spliced members by means other than the column cap.
- 8) Uplift loads do no apply to splice conditions.

New products or updated product information are designated in **blue font**.

Corrosion Finish Key

- Stainless Steel
- Gold Coat
- HDG
- Triple Zinc

Continued on next page

MiTek Stock No.	Ref. No.	Steel Gauge	Dimensions (in)				Fastener Schedule ⁴				DF/SP Allowable Loads (Lbs.) ³		Corrosion Finish	Code Ref.
			W1	W2	H	L	Beam		Column or Post		Bearing ¹ 100%	Uplift ^{2,8} 160%		
							Qty	Type	Qty	Type				
Center Column Caps														
KCCQ71-4	CCQ7.1-4SDS2.5	3	7-1/4	3-5/8	6-1/2	11	16	WS3	14	WS3	48125	7065		IBC, FL, LA
KCCQ71-6	CCQ7.1-6SDS2.5	3	7-1/4	5-1/2	6-1/2	11	16	WS3	14	WS3	48125	7065		
KCCQ71-71	CCQ7.1-7.1SDS2.5	3	7-1/4	7-1/4	6-1/2	11	16	WS3	14	WS3	48125	7065		
KCCQ71-8	CCQ7.1-8SDS2.5	3	7-1/4	7-1/2	6-1/2	11	16	WS3	14	WS3	48125	7065		
KCCQ84	CCQ84SDS2.5	7	7-1/2	3-5/8	6-1/2	11	16	WS3	14	WS3	51565	7065		
KCCQ86	CCQ86SDS2.5	7	7-1/2	5-1/2	6-1/2	11	16	WS3	14	WS3	51565	7065		
KCCQ88	CCQ88SDS2.5	7	7-1/2	7-1/2	6-1/2	11	16	WS3	14	WS3	51565	7065		
KCCQ94	CCQ94SDS2.5	7	8-7/8	3-5/8	6-1/2	11	16	WS3	14	WS3	60155	7065		
KCCQ96	CCQ96SDS2.5	7	8-7/8	5-1/2	6-1/2	11	16	WS3	14	WS3	60155	7065		
KCCQ98	CCQ98SDS2.5	7	8-7/8	7-1/2	6-1/2	11	16	WS3	14	WS3	60155	7065		
KCCQ106	CCQ106SDS2.5	7	9-1/2	5-1/2	6-1/2	11	16	WS3	14	WS3	65315	7065		
End Column Caps														
KECCQ325-4	ECCQ3-4SDS2.5	7	3-1/4	3-5/8	6-1/2	7-1/2	16	WS3	14	WS3	14650	6860		IBC, FL, LA
KECCQ325-6	ECCQ3-6SDS2.5	7	3-1/4	5-1/2	6-1/2	7-1/2	16	WS3	14	WS3	14650	6860		
KECCQ44	ECCQ44SDS2.5	7	3-5/8	3-5/8	6-1/2	8-1/2	16	WS3	14	WS3	16965	6860		
KECCQ45	--	7	3-5/8	5-3/8	6-1/2	7-1/2	16	WS3	14	WS3	16405	6860		
KECCQ46	ECCQ46SDS2.5	7	3-5/8	5-1/2	6-1/2	8-1/2	16	WS3	14	WS3	18595	6860		
KECCQ47	--	7	3-5/8	7-1/8	6-1/2	9-1/2	16	WS3	14	WS3	20780	6860		
KECCQ47X	--	7	3-5/8	7-1/8	8	9-1/2	16	WS3	14	WS3	20780	6860		
KECCQ48	ECCQ48SDS2.5	7	3-5/8	7-1/2	6-1/2	8-1/2	16	WS3	14	WS3	18595	6860		
KECCQ525-4	ECCQ5-4SDS2.5	3	5-1/4	3-5/8	8	9-1/2	16	WS3	14	WS3	22330	6860		
KECCQ525-6	ECCQ5-6SDS2.5	3	5-1/4	5-1/2	8	9-1/2	16	WS3	14	WS3	27300	6860		
KECCQ525-8	ECCQ5-8SDS2.5	3	5-1/4	7-1/2	8	9-1/2	16	WS3	14	WS3	30430	6860		
KECCQ57	--	7	5-3/8	7-1/8	6-1/2	9-1/2	16	WS3	14	WS3	31170	6860		
KECCQ64	ECCQ64SDS2.5	7	5-1/2	3-5/8	6-1/2	8-1/2	16	WS3	14	WS3	23535	6860		
KECCQ66	ECCQ66SDS2.5	7	5-1/2	5-1/2	6-1/2	8-1/2	16	WS3	14	WS3	28910	6860		
KECCQ67X	ECCQ6-7.13SDS2.5	7	5-1/2	7-1/8	6-1/2	8-1/2	16	WS3	14	WS3	29220	6860		
KECCQ68	ECCQ68SDS2.5	7	5-1/2	7-1/2	6-1/2	8-1/2	16	WS3	14	WS3	29220	6860		
KECCQ74	ECCQ74SDS2.5	3	6-7/8	3-5/8	6-1/2	8-1/2	16	WS3	14	WS3	27465	6860		
KECCQ76	ECCQ76SDS2.5	3	6-7/8	5-1/2	6-1/2	8-1/2	16	WS3	14	WS3	35860	6860		
KECCQ77	ECCQ77SDS2.5	3	6-7/8	6-7/8	6-1/2	8-1/2	16	WS3	14	WS3	35860	6860		
KECCQ78	ECCQ78SDS2.5	3	6-7/8	7-1/2	6-1/2	8-1/2	16	WS3	14	WS3	35860	6860		
KECCQ71-4	ECCQ7.1-4SDS2.5	3	7-1/4	3-5/8	6-1/2	8-1/2	16	WS3	14	WS3	28240	6860		
KECCQ71-6	ECCQ7.1-6SDS2.5	3	7-1/4	5-1/2	6-1/2	8-1/2	16	WS3	14	WS3	35285	6860		
KECCQ71-71	ECCQ7.1-7.1SDS2.5	3	7-1/4	7-1/4	6-1/2	8-1/2	16	WS3	14	WS3	37190	6860		
KECCQ71-8	ECCQ7.1-8SDS2.5	3	7-1/4	7-1/2	6-1/2	8-1/2	16	WS3	14	WS3	37190	6860		
KECCQ84	ECCQ84SDS2.5	7	7-1/2	3-5/8	6-1/2	8-1/2	16	WS3	14	WS3	29785	6860		
KECCQ86	ECCQ86SDS2.5	7	7-1/2	5-1/2	6-1/2	8-1/2	16	WS3	14	WS3	37390	6860		
KECCQ88	ECCQ88SDS2.5	7	7-1/2	7-1/2	6-1/2	8-1/2	16	WS3	14	WS3	39845	6860		
KECCQ94	ECCQ94SDS2.5	7	8-7/8	3-5/8	6-1/2	8-1/2	16	WS3	14	WS3	33595	6860		
KECCQ96	ECCQ96SDS2.5	7	8-7/8	5-1/2	6-1/2	8-1/2	16	WS3	14	WS3	42630	6860		
KECCQ98	ECCQ98SDS2.5	7	8-7/8	7-1/2	6-1/2	8-1/2	16	WS3	14	WS3	46485	6860		
KECCQ106	ECCQ106SDS2.5	7	9-1/2	5-1/2	6-1/2	8-1/2	16	WS3	14	WS3	45760	6860		

Caps & Bases

Copyright © 2022 MiTek Industries, Inc. All Rights Reserved

- 1) Bearing loads are based on 625 psi perpendicular to grain loading; no further increase for duration of load is permitted.
 - 2) Uplift loads have been increased 60% for wind or seismic loads; no further increase shall be permitted.
 - 3) Allowable loads are based on lumber with a specific gravity of 0.50 and a moisture content of 19% or less.
 - 4) MiTek WS3 structural wood screws are 1/4" dia. x 3" long and are included with KCCQ and KECCQ column caps.
 - 5) Beams shall be designed to support the required loads. Beam shear may limit loads to less than listed loads for device.
 - 6) The designer shall check post for required loads.
 - 7) Spliced conditions must be detailed by the specifier to transfer tension loads between spliced members by means other than the column cap.
 - 8) Uplift loads do no apply to splice conditions.
- Corrosion Finish Key**
■ Stainless Steel ■ Gold Coat
■ HDG ■ Triple Zinc

Continued on next page

Specialty Options:

- **KECCQ** – Straps may be rotated 90° with no reduction in published capacity on special orders where the W2 dimension is less than or equal to the W1 dimension. When W2 is greater than W1 uplift loads may be reduced, consult MiTek Engineering support.
- **KCCQO/KECCQO** – Cap only, no strap design for field welding to pipe or other columns.
- **KCCQOB** – For + beam connections. Any two buckets can be welded together for a wide variety of applications. Allowable load shall be the lesser of the two components.
- **KCCQT** – For T beam intersections, consult MiTek. Specify beam/column conditions, dimensions, and loading requirements.
- **KCCQC** – For X beam intersections, consult MiTek. Specify beam/column conditions, dimensions, and loading requirements.
- **KECCQL** – For L beam intersections, consult MiTek. Specify left (L) or right (R) beam/column conditions, dimensions, and loading requirements.

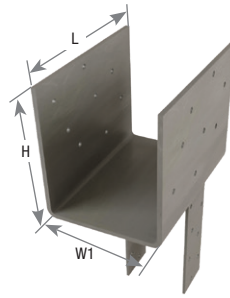

Optional KECCQ rotated straps 90°

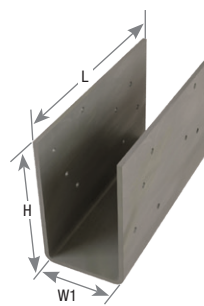

KCCQO

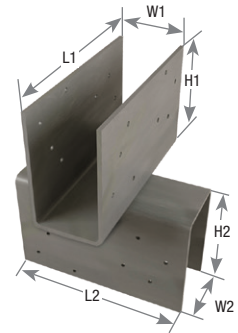

KCCQOB

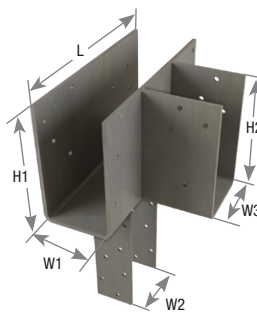

KCCQT

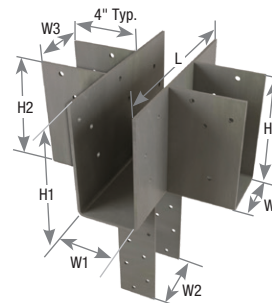

KCCQC

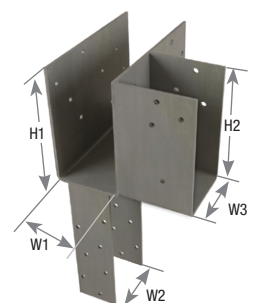

KECCQLL left shown

Dimension call-outs not shown in the table must be specified at time of ordering for specialty options, non-catalog, or rough/full size lumber sizes.

Refer to Options for Multiple-Beam Column Caps Special Order Worksheet for ordering instructions at MiTek-US.com on KCCQ/KECCQ Column Caps web page.

Top View of Specialty Options Column Cap Configurations



KECCQLL rotated 90°



KECCQLR rotated 90°

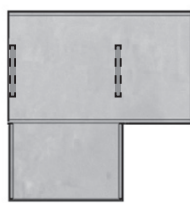

KECCQLL



KECCQLR



KECCQ offset left



KECCQ offset right



KCCQ offset left



KCCQ offset right

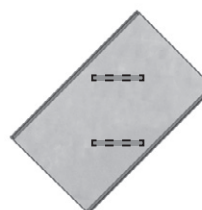

KCCQ rotated 45° left

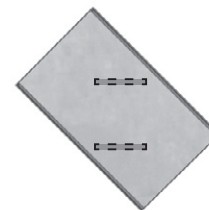

KCCQ rotated 45° right

KCC – Standard column cap.

KECC – End column version.

Materials: See chart

Finish: Primer

Options: See chart for Corrosion Finish Options.

See page 105 for Specialty Options. All nominal lumber sizes are available for rough/full size lumber.

Codes: IBC, FL, LA

Installation:

- Use all specified fasteners. See Product Notes, page 18.
- Bolt holes should be a minimum of 1/32" to a maximum of 1/16" larger than the bolt diameter.
- Beams shall be designed to support the required loads. Beam shear may limit loads to less than listed loads for device. A design professional shall determine the adequacy of the post and beam to resist published loads.



Typical KECC44 end cap installation



Typical KCC center cap installation

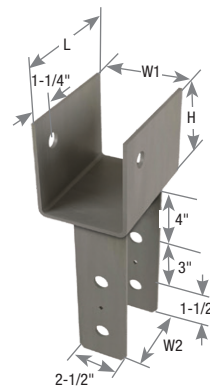

KECC44

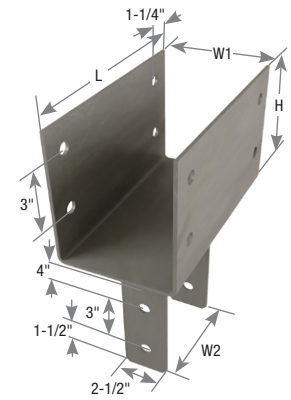

KCC

MiTek Stock No.	Ref. No.	Steel Gauge	Dimensions (in)				Fastener Schedule ⁴		DF/SP Allowable Loads (Lbs.) ³		Corrosion Finish	Code Ref.
			W1	W2	H	L	Beam	Column or Post	Bearing ¹	Uplift ^{2,8}		
									100%	160%		
Center Column Caps												
KCC325-4	CC31/4-4	7	3-1/4	3-5/8	6-1/2	11	(4) 5/8	(2) 5/8	21485	3505		IBC, FL, LA
KCC325-6	CC31/4-6	7	3-1/4	5-1/2	6-1/2	11	(4) 5/8	(2) 5/8	21485	3505		
KCC44	CC44	7	3-5/8	3-5/8	4	7	(2) 5/8	(2) 5/8	15315	3920		
KCC45	--	7	3-5/8	5-3/8	6-1/2	11	(4) 5/8	(2) 5/8	24065	3920		
KCC46	CC46	7	3-5/8	5-1/2	6-1/2	11	(4) 5/8	(2) 5/8	24065	3920		
KCC47	--	7	3-5/8	7-1/8	6-1/2	11	(4) 5/8	(2) 5/8	24065	3920		
KCC48	CC48	7	3-5/8	7-1/2	6-1/2	11	(4) 5/8	(2) 5/8	24065	3920		
KCC525-4	CC51/4-4	3	5-1/4	3-5/8	8	13	(4) 3/4	(2) 3/4	41640	8155		
KCC525-6	CC51/4-6	3	5-1/4	5-1/2	8	13	(4) 3/4	(2) 3/4	41640	8155		
KCC525-8	CC51/4-8	3	5-1/4	7-1/2	8	13	(4) 3/4	(2) 3/4	41640	8155		
KCC57	CC6-71/8	7	5-3/8	7-1/8	6-1/2	11	(4) 5/8	(2) 5/8	36095	4210		
KCC64	CC64	7	5-1/2	3-5/8	6-1/2	11	(4) 5/8	(2) 5/8	37815	4210		
KCC66	CC66	7	5-1/2	5-1/2	6-1/2	11	(4) 5/8	(2) 5/8	37815	4210		
KCC68	CC68	7	5-1/2	7-1/2	6-1/2	11	(4) 5/8	(2) 5/8	37815	4210		

1) Bearing loads are based on 625 psi perpendicular to grain loading; no further increase for duration of load is permitted.
 2) Uplift loads have been increased 60% for wind or seismic loads; no further increase shall be permitted.
 3) Allowable loads are based on lumber with a specific gravity of 0.50 and a moisture content of 19% or less.
 4) All bolts shall meet or exceed the specifications of ASTM A 307.
 5) Beams shall be designed to support the required loads. Beam shear may limit loads to less than listed loads for device.
 6) The designer shall check post for required loads.
 7) Spliced conditions must be detailed by the specifier to transfer tension loads between spliced members by means other than the column cap.
 8) Uplift loads do not apply to splice conditions.

New products or updated product information are designated in **blue font**.

Corrosion Finish Key

- Stainless Steel
- Gold Coat
- HDG
- Triple Zinc

Copyright © 2022 MiTek Industries, Inc. All Rights Reserved

Caps & Bases

Continued on next page

Installation:

- Use all specified fasteners. See Product Notes, page 18.
- Bolt holes should be a minimum of 1/32" to a maximum of 1/16" larger than the bolt diameter.
- Beams shall be designed to support the required loads. Beam shear may limit loads to less than listed loads for device. A design professional shall determine the adequacy of the post and beam to resist published loads.

MiTek Stock No.	Ref. No.	Steel Gauge	Dimensions (in)				Fastener Schedule ⁴		DF/SP Allowable Loads (Lbs.) ³		Corrosion Finish	Code Ref.
			W1	W2	H	L	Beam	Column or Post	Bearing ¹	Uplift ^{2,8}		
									100%	160%		
Center Column Caps												
KCC74	CC74	3	6-7/8	3-5/8	8	13	(4) 3/4	(2) 3/4	54845	8155		IBC, FL, LA
KCC76	CC76	3	6-7/8	5-1/2	8	13	(4) 3/4	(2) 3/4	54845	8155		
KCC77	CC77	3	6-7/8	6-7/8	8	13	(4) 3/4	(2) 3/4	54845	8155		
KCC78	CC78	3	6-7/8	7-1/2	8	13	(4) 3/4	(2) 3/4	54845	8155		
KCC75X	CC71/8-6	3	7-1/8	5-1/2	8	13	(4) 3/4	(2) 3/4	56875	8155		
KCC77X	CC71/8-71/8	3	7-1/8	7-1/8	8	13	(4) 3/4	(2) 3/4	56875	8155		
KCC84	CC84	3	7-1/2	3-5/8	8	13	(4) 3/4	(2) 3/4	60940	8155		
KCC86	CC86	3	7-1/2	5-1/2	8	13	(4) 3/4	(2) 3/4	60940	8155		
KCC88	CC88	3	7-1/2	7-1/2	8	13	(4) 3/4	(2) 3/4	60940	8155		
KCC94	CC94	3	8-7/8	3-5/8	8	13	(4) 3/4	(2) 3/4	71095	8155		
KCC96	CC96	3	8-7/8	5-1/2	8	13	(4) 3/4	(2) 3/4	71095	8155		
KCC98	CC98	3	8-7/8	7-1/2	8	13	(4) 3/4	(2) 3/4	71095	8155		
KCC106	CC106	3	9-5/8	5-1/2	8	13	(4) 3/4	(2) 3/4	77190	8155		
End Column Caps												
KECC325-4	ECC31/4-4	7	3-1/4	3-5/8	6-1/2	7-1/2	(2) 5/8	(2) 5/8	14650	1750		IBC, FL, LA
KECC325-6	ECC31/4-6	7	3-1/4	5-1/2	6-1/2	7-1/2	(2) 5/8	(2) 5/8	14650	1750		
KECC44	ECC44	7	3-5/8	3-5/8	4	5-1/2	(1) 5/8	(2) 5/8	12030	1960		
KECC45	--	7	3-5/8	5-3/8	6-1/2	7-1/2	(2) 5/8	(2) 5/8	16405	1960		
KECC46	ECC46	7	3-5/8	5-1/2	6-1/2	8-1/2	(2) 5/8	(2) 5/8	18595	1960		
KECC47	--	7	3-5/8	7-1/8	6-1/2	9-1/2	(2) 5/8	(2) 5/8	20780	1960		
KECC48	ECC48	7	3-5/8	7-1/2	6-1/2	9-1/2	(2) 5/8	(2) 5/8	20780	1960		
KECC525-4	ECC51/4-4	3	5-1/4	3-5/8	8	9-1/2	(2) 3/4	(2) 3/4	30430	6050		
KECC525-6	ECC51/4-6	3	5-1/4	5-1/2	8	9-1/2	(2) 3/4	(2) 3/4	30430	6050		
KECC525-8	ECC51/4-8	3	5-1/4	7-1/2	8	9-1/2	(2) 3/4	(2) 3/4	30430	6050		
KECC57	ECC6-71/8	7	5-3/8	7-1/8	6-1/2	9-1/2	(2) 5/8	(2) 5/8	31170	2105		
KECC64	ECC64	7	5-1/2	3-5/8	6-1/2	7-1/2	(2) 5/8	(2) 5/8	25780	2105		
KECC66	ECC66	7	5-1/2	5-1/2	6-1/2	7-1/2	(2) 5/8	(2) 5/8	25780	2105		
KECC68	ECC68	7	5-1/2	7-1/2	6-1/2	9-1/2	(2) 5/8	(2) 5/8	32655	2105		
KECC74	ECC74	3	6-7/8	3-5/8	8	10-1/2	(2) 3/4	(2) 3/4	44295	6050		
KECC76	ECC76	3	6-7/8	5-1/2	8	10-1/2	(2) 3/4	(2) 3/4	44295	6050		
KECC77	ECC77	3	6-7/8	6-7/8	8	10-1/2	(2) 3/4	(2) 3/4	44295	6050		
KECC78	ECC78	3	6-7/8	7-1/2	8	10-1/2	(2) 3/4	(2) 3/4	44295	6050		
KECC75X	ECC71/8-6	3	7-1/8	5-1/2	8	10-1/2	(2) 3/4	(2) 3/4	45940	6050		
KECC77X	ECC71/8-71/8	3	7-1/8	7-1/8	8	10-1/2	(2) 3/4	(2) 3/4	45940	6050		
KECC84	ECC84	3	7-1/2	3-5/8	8	10-1/2	(2) 3/4	(2) 3/4	49220	6050		
KECC86	ECC86	3	7-1/2	5-1/2	8	10-1/2	(2) 3/4	(2) 3/4	49220	6050		
KECC88	ECC88	3	7-1/2	7-1/2	8	10-1/2	(2) 3/4	(2) 3/4	49220	6050		
KECC94	ECC94	3	8-7/8	3-5/8	8	10-1/2	(2) 3/4	(2) 3/4	57420	6050		
KECC96	ECC96	3	8-7/8	5-1/2	8	10-1/2	(2) 3/4	(2) 3/4	57420	6050		
KECC98	ECC98	3	8-7/8	7-1/2	8	10-1/2	(2) 3/4	(2) 3/4	57420	6050		
KECC106	ECC106	3	9-5/8	5-1/2	8	10-1/2	(2) 3/4	(2) 3/4	62345	6050		

- 1) Bearing loads are based on 625 psi perpendicular to grain loading; no further increase for duration of load is permitted.
- 2) Uplift loads have been increased 60% for wind or seismic loads; no further increase shall be permitted.
- 3) Allowable loads are based on lumber with a specific gravity of 0.50 and a moisture content of 19% or less.
- 4) All bolts shall meet or exceed the specifications of ASTM A 307.
- 5) Beams shall be designed to support the required loads. Beam shear may limit loads to less than listed loads for device.
- 6) The designer shall check post for required loads.
- 7) Spliced conditions must be detailed by the specifier to transfer tension loads between spliced members by means other than the column cap.
- 8) Uplift loads do not apply to splice conditions.

Corrosion Finish Key ■ Stainless Steel ■ Gold Coat ■ HDG ■ Triple Zinc

Continued on next page

Caps & Bases

Specialty Options:

- **KECC** – Straps may be rotated 90° on special order where the W2 dimension is less than or equal to the W1 dimension. Unless specified W3 and W4 dimensions are equal to the W1 dimension, and H2 and H3 dimensions are equal to the H1 dimension.
- **KCCO/KECCO** – Cap only, no strap design for field welding to pipe or other columns.
- **KCCOB** – For cross beam connections. Any two buckets can be welded together for a wide variety of applications. Allowable load shall be the lesser of the two components.
- **KCCT** – For T beam intersections, consult MiTek. Specify beam/column conditions, dimensions, and loading requirements.
- **KCCC** – For X beam intersections, consult MiTek. Specify beam/column conditions, dimensions, and loading requirements.
- **KECCL** – For L beam intersections, consult MiTek. Specify left (L) or right (R) beam/column conditions, dimensions, and loading requirements.

Dimension call-outs not shown in the table must be specified at time of ordering for specialty options, non-catalog, or rough/full size lumber sizes.

Refer to Options for Multiple-Beam Bolted Column Caps Special Order Worksheet for ordering instructions at MiTek-US.com on KCC/KECC Column Caps web page.

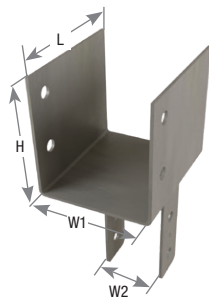

Optional KECC rotated straps 90°

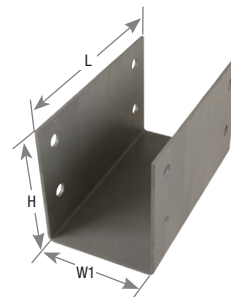

KCCO

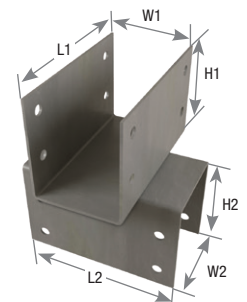

KCCOB

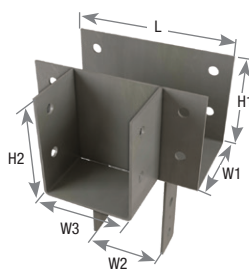

KCCT

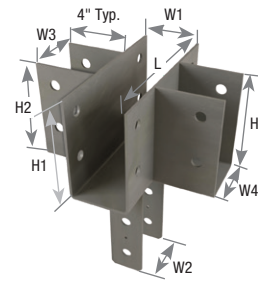

KCCC

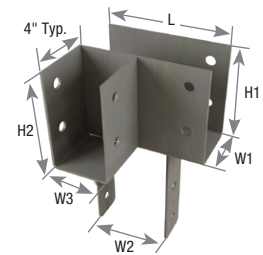

KECCL left shown

Top View of Specialty Options Column Cap Configurations



KECCLL rotated 90°



KECCLR rotated 90°

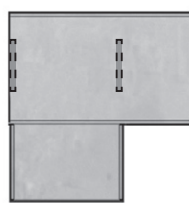

KECCLL

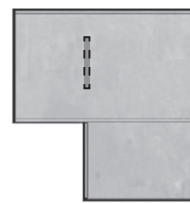

KECCLR



KECC offset left



KECC offset right



KCC offset left



KCC offset right

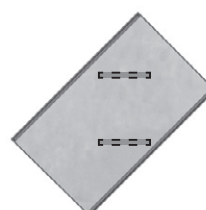

KCC rotated 45° left

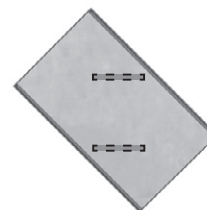

KCC rotated 45° right

ANGLES & STRAPS



ANGLES & STRAPS

108-135

Angles	108-111, 113-115
Clips	112, 118-119
Header Hangers	118
Knee Braces	135
Lateral Joist Connectors	120
Ornamental Connectors	125
Straps	121-134
Stud Plate Ties	116-117

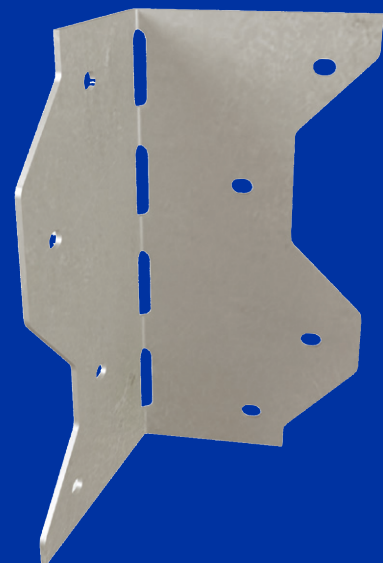

A / AC / JA / MP Framing Angles

Angles & Straps

MP – 18 gauge. Field adjustable from 45° to 180° (flat)

A3 – 18 gauge. Eliminates toenailing and increases strength

AC – 16 gauge. Features staggered nail patterns which reduces wood splitting and allows installation on both sides of the supported member

JA – 14 or 16 gauge. Heavier capacity framing angle for joist support

Materials: See chart

Finish: G90 galvanizing

Options: See chart for Corrosion Finish Options

Codes: IBC, FL, LA

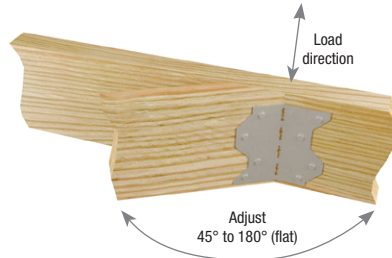

Typical MP installation



Typical MP rafter support installation

AVAILABLE IN
**GOLD
COAT**

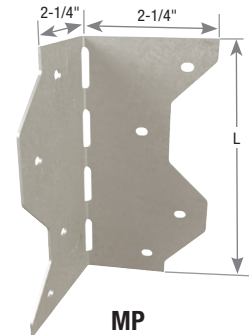

MP



Typical JA1 installation

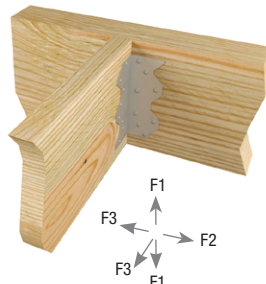

Typical JA7 installation

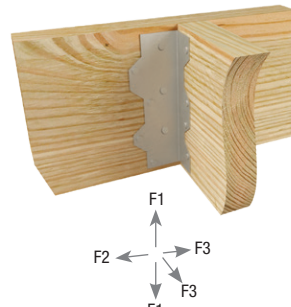

Typical AC installation

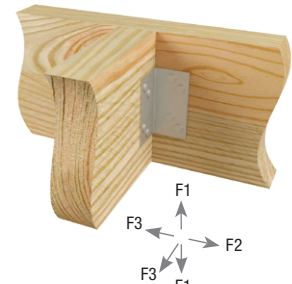

Typical A3 installation

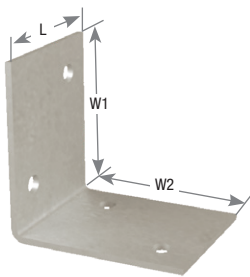

JA1

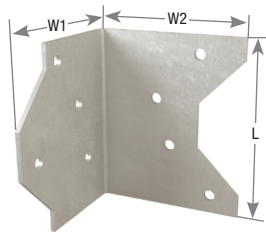

JA7



AC

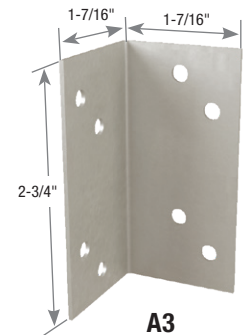

A3

Continued on next page

Installation:

- Use all specified fasteners. See Product Notes, page 18.
- MP Framing Angles are fabricated at 100° and may be field adjusted by hand from 45° to 180° (flat). Bend angle only once.

MiTek Stock No.	Ref. No.	Steel Gauge	Dimensions (in)			Fastener Schedule ^{3,4}				Direction of Load	DF/SP Allowable Loads (Lbs.) ^{1,2}				S-P-F Allowable Loads (Lbs.) ^{1,2}				Corrosion Finish	Code Ref.
			W1	W2	L	Header		Joist			100%	115%	125%	160%	100%	115%	125%	160%		
						Qty	Type	Qty	Type											
A3	A23, GA1, GA2, L30	18	1-7/16	1-7/16	2-3/4	4	10d x 1-1/2	4	10d x 1-1/2	F1	480	545	590	740	410	470	510	520	Green	
										F2	480	545	590	605	410	470	485	505		
										F3	375	375	375	375	145	165	180	230		
MP3	LS30	18	2-1/4	2-1/4	3-3/8	3	10d	3	10d	F1	360	410	445	455	310	350	380	380	Green	
MP5	LS50	18	2-1/4	2-1/4	4-5/8	4	10d	4	10d	F1	480	545	590	740	410	470	505	640	Green	
MP7	LS70	18	2-1/4	2-1/4	5-7/8	5	10d	5	10d	F1	600	685	740	930	515	585	630	800	Green	
MP9	LS90	18	2-1/4	2-1/4	6-7/8	6	10d	6	10d	F1	720	820	885	1115	620	705	760	960	Green	
AC5	L50	16	1-5/16	2-3/8	4-7/8	3	10d	3	10d	F1	375	420	455	565	330	370	400	500	Green	
										F2	375	420	455	565	330	370	400	475		
										F3	155	180	195	250	105	120	135	170		
						3	16d	3	16d	F1	440	500	540	670	385	440	475	590		
										F2	440	500	540	595	385	440	475	475		
										F3	175	205	220	280	120	140	150	190		
AC7	L70	16	1-5/16	2-3/8	6-15/16	4	10d	4	10d	F1	500	560	605	755	440	495	530	665	Yellow	
										F2	500	560	605	755	440	495	530	665		
										F3	210	240	260	335	140	165	175	225		
						4	16d	4	16d	F1	590	665	720	895	515	585	630	785		
										F2	590	665	720	895	515	585	630	735		
										F3	235	270	295	375	160	185	200	255		
AC9	L90	16	1-5/16	2-3/8	8-7/8	5	10d	5	10d	F1	625	700	755	945	550	615	665	830	Green	IBC, FL, LA
										F2	625	700	755	900	550	615	665	715		
										F3	260	300	325	415	175	205	220	285		
						5	16d	5	16d	F1	735	835	900	1120	645	730	790	985		
										F2	735	835	900	900	645	720	720	720		
										F3	295	340	370	470	200	230	250	320		
JA1	A21	16	1-1/2	1-1/2	1-1/4	2	10d x 1-1/2	2	10d x 1-1/2	F1	220	220	220	220	195	195	195	195	Green	
										F2	--	--	--	300	--	--	--	235		
										F3	--	--	--	150	--	--	--	100		
JA3	--	14	2-1/2	2-1/2	3	4	16d	4	10d x 1-1/2	F1	495	495	495	495	445	445	445	445	Green	
										F2	--	--	--	465	--	--	--	365		
										F3	--	--	--	330	--	--	--	225		
JA5	--	14	2-1/2	2-1/2	5	6	16d	6	10d x 1-1/2	F1	790	825	825	825	715	740	740	740	Green	
										F2	--	--	--	890	--	--	--	695		
										F3	--	--	--	495	--	--	--	335		
JA7	--	14	2-1/2	2-1/2	7	8	16d	8	10d x 1-1/2	F1	1055	1185	1270	1560	955	1070	1145	1410	Green	
										F2	--	--	--	1450	--	--	--	1135		
										F3	--	--	--	490	--	--	--	335		
JA9	--	14	2-1/2	2-1/2	9	10	16d	10	10d x 1-1/2	F1	1320	1485	1590	1950	1190	1340	1430	1760	Green	
										F2	--	--	--	1465	--	--	--	1150		
										F3	--	--	--	775	--	--	--	530		

1) Allowable loads have been increased 60% for wind and seismic loads; no further increase shall be permitted.
 2) Loads are shown per angle, and may be doubled if installed in pairs. When using a single angle, joist must be constrained from rotation.
 3) Stainless steel ring shank nails must be used with stainless steel connectors to achieve tabulated allowable loads.
 4) **NAILS:** 10d x 1-1/2 nails are 0.148" dia. x 1-1/2" long, 10d nails are 0.148" dia. x 3" long, 16d nails are 0.162" dia. x 3-1/2" long.
 New products or updated product information are designated in blue font.

Corrosion Finish Key ■ Stainless Steel ■ Gold Coat ■ HDG ■ Triple Zinc

MP34 – Framing angle without tabs

MPA1 – Tabs enable two and three-way connections

MP4F – Connects 2x framing with floor sheathing up to 5/8"

MP6F – Connects 3x framing with floor sheathing up to 3/4". Better choice for connections where floor sheathing is between sole plate and rim board

Materials: See chart

Finish: G90 galvanizing

Options: See chart for Corrosion Finish Options

Codes: IBC, FL, LA



MPA1



Typical MP34 installation



MPA1-GC

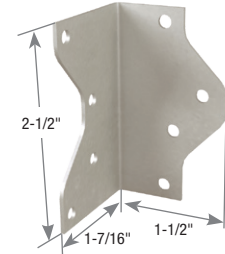

MP34

AVAILABLE IN
**GOLD
COAT**

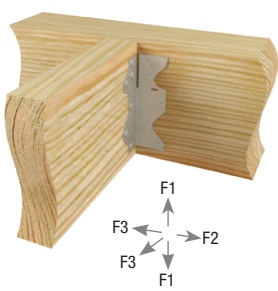

Typical MPA1 joist / header installation

Figure 1

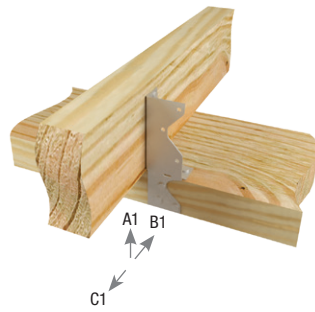

Typical MPA1 rafter / plate installation

Figure 2

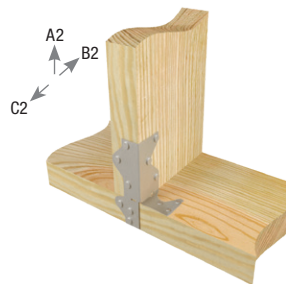

Typical MPA1 stud / plate installation

Figure 3

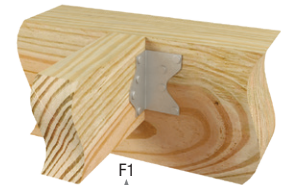

Typical MP34 joist / header installation

Figure 4

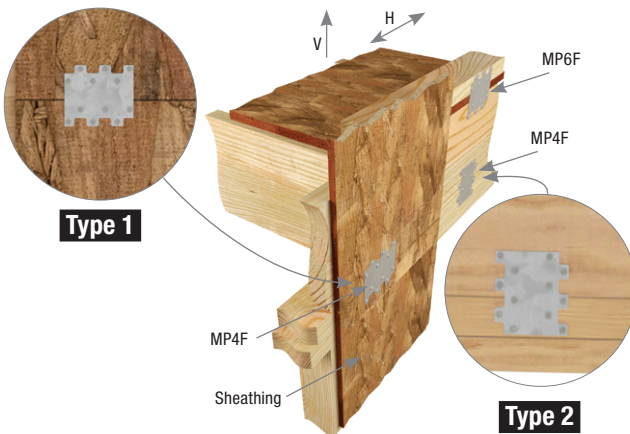

Typical MPF installation

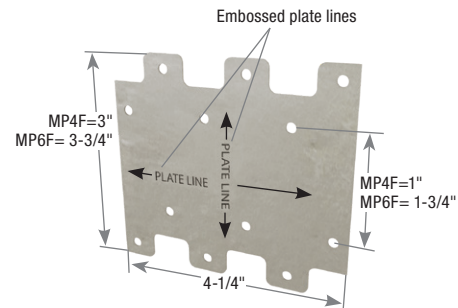

MPF

Copyright © 2022 MiTek Industries, Inc. All Rights Reserved

Continued on next page

Angles & Straps

Installation:

- Use all specified fasteners. See Product Notes, page 18.
- Bend tabs only once.

MiTek Stock No.	Ref. No.	Steel Gauge	Installation Type ^{2,4}	Fastener Schedule ^{5,6}				Direction of Load ²	DF/SP Allowable Loads (Lbs.) ^{1,3,4}				S-P-F Allowable Loads (Lbs.) ^{1,3,4}				Corrosion Finish	Code Ref.
				Header or Stud		Joist or Plate			100%	115%	125%	160%	100%	115%	125%	160%		
				Qty	Type	Qty	Type											
MPA1	A35	18	Figure 1	6	8d x 1-1/2	6	8d x 1-1/2	F1	600	615	615	615	515	515	515	515	Stainless Steel	IBC, FL, LA
								F2	600	685	735	750	515	585	630	630		
								F3	280	320	350	435	180	205	225	290		
			Figure 2	6	8d x 1-1/2	3	8d x 1-1/2	A1	300	340	370	370	260	295	310	310		
								B1	300	340	370	385	260	295	315	325		
								C1	255	255	255	255	215	215	215	215		
			Figure 3	6	8d x 1-1/2	6	8d x 1-1/2	A2	440	440	440	440	350	370	370	370		
								B2	240	240	240	240	200	200	200	200		
								C2	330	330	330	330	280	280	280	280		
MP34	A34	18	Figure 4	4	8d x 1-1/2	4	8d x 1-1/2	F1	400	455	490	525	345	390	420	440	Stainless Steel	IBC, FL, LA
								F2	400	455	490	590	345	390	420	495		
								F3	185	215	230	295	120	140	150	190		
MP4F	LTP4	20	Type 1	6	8d x 1-1/2	6	8d x 1-1/2	V	590	670	720	750	505	575	615	645	Stainless Steel	IBC, FL, LA
								H	590	670	720	750	505	575	615	645		
			Type 2	6	8d x 1-1/2	6	8d x 1-1/2	V	590	670	720	750	505	575	615	645		
								H	585	585	585	585	500	500	500	500		
			Type 1	6	8d	6	8d	V	590	670	720	750	505	575	615	645		
								H	590	670	720	750	505	575	615	645		
Type 2	6	8d	6	8d	V	590	670	720	750	505	575	615	645					
					H	585	585	585	585	500	500	500	500					
MP6F	LTP5	20	Type 1	6	8d x 1-1/2	6	8d x 1-1/2	V	590	595	595	595	505	510	510	510	Stainless Steel	IBC, FL, LA
								H	590	595	595	595	505	510	510	510		
			Type 2	6	8d x 1-1/2	6	8d x 1-1/2	V	590	595	595	595	505	510	510	510		
								H	590	595	595	595	505	510	510	510		
			Type 1	6	8d	6	8d	V	590	595	595	595	505	510	510	510		
								H	590	595	595	595	505	510	510	510		
Type 2	6	8d	6	8d	V	590	595	595	595	505	510	510	510					
					H	590	595	595	595	505	510	510	510					

- 1) Allowable loads have been increased 60% for wind or seismic loads; no further increase shall be permitted.
 - 2) Refer to drawings for installation type and definition of the various load directions.
 - 3) If installing MP4F or MP6F over plywood, use 8d common nails for 100% of table load.
 - 4) Loads are shown per angle. When using a single anchor, joist must be constrained from rotation.
 - 5) Stainless steel ring shank nails must be used with stainless steel connectors to achieve tabulated allowable loads.
 - 6) **NAILS:** 8d x 1-1/2 nails are 0.131" dia. x 1-1/2" long, 8d nails are 0.131" dia. x 2-1/2" long
- New products or updated product information are designated in **blue font**.

Corrosion Finish Key ■ Stainless Steel ■ Gold Coat ■ HDG ■ Triple Zinc

RBC Roof Boundary Clip

Angles & Straps

Framing plate designed to connect roof blocking to a wall top plate.

Materials: 20 gauge

Finish: G90 galvanizing

Codes: IBC, FL, LA

Installation:

- Use all specified fasteners. See Product Notes, page 18.
- Field adjustable from 0° to 45°.
- **Bend angle only once.**

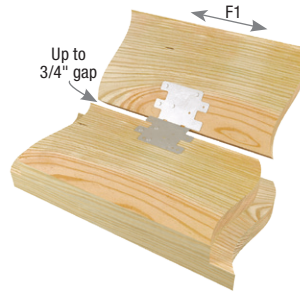

Typical RBC top-plate to inside of blocking installation

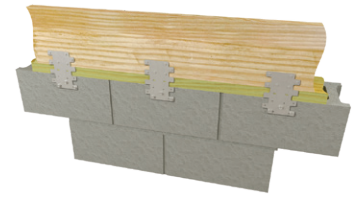

Typical RBC concrete block wall to blocking installation

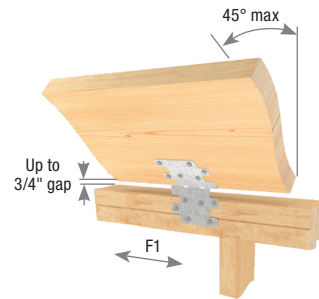

Typical RBC top-plate to outside of blocking installation

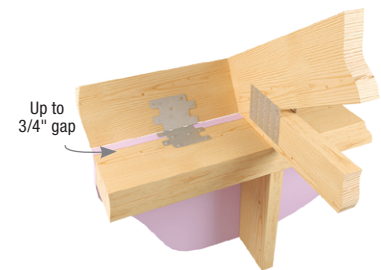

Typical RBC 1" foamboard installation

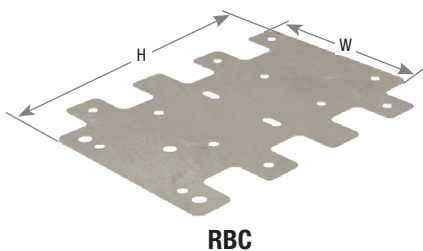

RBC

MiTek Stock No.	Ref. No.	Steel Gauge	Dimensions (in)		Installation Type	Fastener Schedule ^{3,4}				DF/SP Allowable Loads (Lbs.) ^{1,2}	S-P-F Allowable Loads (Lbs.) ^{1,2}	Code Ref.
			W	H		Top Plate		Blocking				
						Qty	Type ^{2,3}	Qty	Type ²	F1 160%	F1 160%	
RBC	RBC	20	4-1/4	6	Wood	6	10d x 1-1/2	6	10d x 1-1/2	505	440	IBC, FL, LA
					CMU	3	1/4" Tapcon	6	10d x 1-1/2	425	370	

1) Allowable loads have been increased 60% for wind or seismic loads; no further increase shall be permitted.

2) Loads shown are for a single roof boundary clip.

3) Use ITW-Buildex 1/4" x 2-1/4" Tapcons; or equal, installed in accordance with manufacturer's specifications.

4) **NAILS:** 10d x 1-1/2 nails are 0.148" diameter by 1-1/2" long.

New products or updated product information are designated in **blue font**.

ML Angles

Angles & Straps

ML angles are multi-purpose angles that install easily with MiTek's WS15 structural wood screws. The staggered fastener pattern allows for back-to-back installations.

Materials: 12 gauge
Finish: G-185 galvanizing
Codes: IBC, FL, LA

Installation:

- Use all specified fasteners. See Product Notes, page 18.
- MiTek WS15 structural wood screws (1/4" dia. x 1-1/2" long) are not supplied with ML angles.



Typical ML26-TZ installation
(ML24-TZ similar)

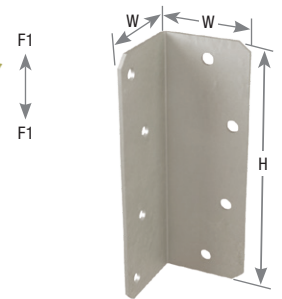

ML26-TZ
(ML24-TZ similar)

MiTek Stock No.	Ref. No.	Steel Gauge	Dimensions (in)			Fastener Schedule ^{2,3}			DF/SP Allowable Loads (Lbs.) ¹				S-P-F Allowable Loads (Lbs.) ¹				Corrosion Finish	Code Ref.
			W	H	Header Qty	Joist Qty	Type	F1				F1						
								100%	115%	125%	160%	100%	115%	125%	160%			
ML24-TZ	ML24Z	12	2	4	3	3	WS15	655	655	655	655	565	650	655	655	IBC, FL, LA		
ML26-TZ	ML26Z	12	2	6	4	4	WS15	920	1060	1090	1090	755	865	940	1090			

1) Allowable loads have been increased 60% for wind and seismic loads; no further increase shall be permitted.
 2) MiTek's WS15 structural wood screws are 1/4" dia. x 1-1/2" long and are not included with angles.
 3) For exterior applications use MiTek's WS15-EXT structural wood screws with exterior coat finish.

Corrosion Finish Key ■ Stainless Steel ■ Gold Coat ■ HDG ■ Triple Zinc

TDL Concrete Angles

These angles secure wood posts to concrete or wood floors in light-duty applications.

Materials: 12 gauge
Finish: G90 galvanizing
Options: See chart for Corrosion Finish Options

Installation:

- Use specified fasteners. See Product Notes, page 18.
- The TDL10 can be embedded into concrete. Minimum embedment depth is 4" to achieve allowable loads.
- **Moisture barrier may be required.**



Typical TDL5 nail installation

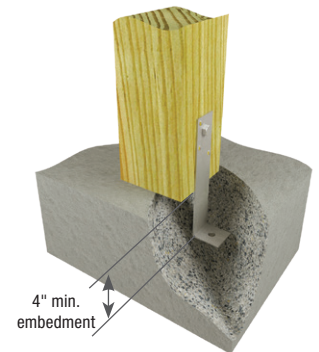

Typical TDL10 embedded bolt installation

MiTek Stock No.	Ref. No.	Steel Gauge	Dimensions (in)			Fastener Schedule				DF/SP Allowable Loads (Lbs.) ^{1,2,3}		Corrosion Finish	Code Ref.
			W	H	D	Anchor Bolt ⁴		Strap		Uplift 160%			
						Qty	Dia. (in)	Qty	Type ⁵				
TDL5	A24	12	2	5-3/16	2-1/4	1	1/2	4	16d	955		■	--
								1	1/2	1105			
TDL10	A311	12	2	9-3/4	2-1/4	1	1/2	4	16d	955		■	--
								1	1/2	1105			

1) Allowable loads are based on the use of either nails or bolts; nail and bolt values cannot be combined.
 2) The bolt values are based on single shear with a minimum member thickness of 3-1/2".
 3) Allowable loads have been increased in accordance with the code; no further increase shall be permitted.
 4) Designer must specify anchor bolt type, length, and embedment.
 5) **NAILS:** 16d nails are 0.162" dia. x 3-1/2" long.

Corrosion Finish Key ■ Stainless Steel ■ Gold Coat ■ HDG ■ Triple Zinc

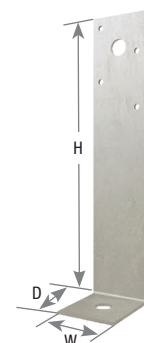

TDL10

Copyright © 2022 MiTek Industries, Inc. All Rights Reserved

Angles & Straps

B / BL Corner Braces

Angles & Straps

These multi-purpose braces are designed to provide reinforcement for 90° wood-to-wood connections.

Materials: 12 gauge
Finish: G90 galvanizing

Some model designs may vary from illustration shown

Installation:

- Use all specified fasteners. See Product Notes, page 18.

MiTek Stock No.	Ref. No.	Steel Gauge	Dimensions (in)		Fastener Schedule				DF/SP Allowable Loads (Lbs.) ^{1,2}		Code Ref.
			W	L	Nails ⁵		Bolts ⁵		F1 ³ 160%	F2 160%	
					Qty	Type	Qty	Type			
B23	--	12	2	2-5/8	6	16d	--	--	--	--	--
B24	--	12	2	3-5/8	8	16d	--	--	--	--	--
BL3	A33	12	1-1/4	3-1/16	8	10d	--	--	735	285	--
BL4	A44	12	1-1/4	4-13/16	10	10d	--	--	720	275	--
BL6	--	12	1-1/4	6-9/16	12	16d	--	--	--	--	--
BL8	--	12	1-1/4	8-5/16	14	16d	--	--	--	--	--
B66	A66	12	1-1/2	6	--	--	4	3/8	710	335	--
B88	A88	12	2	8	--	--	6	3/8	620	305	--

- 1) Allowable loads have been increased 60% for wind or seismic loads; no further increase shall be permitted.
- 2) Loads shown are for a single corner brace.
- 3) Corner braces are required on both sides to achieve F1 loads in both directions.
- 4) Minimum member thickness is 3".
- 5) Bolts shall conform to ASTM A 307 or better.
- 6) **NAILS:** 10d nails are 0.148" dia. x 3" long, 16d nails are 0.162" dia. x 3-1/2" long. New products or updated product information are designated in blue font.

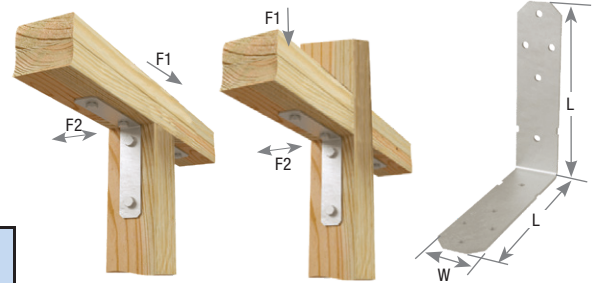

Typical B66 installations

BL4

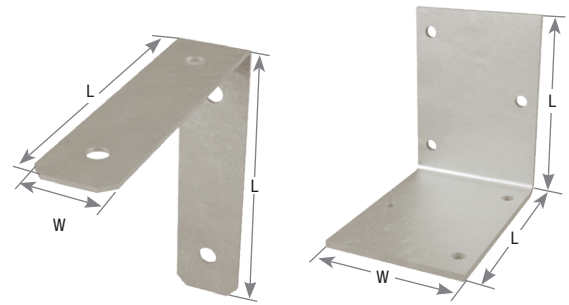

B66

B23

KHL Heavy Angles

Designed for heavy-duty reinforcement of 90° framing intersections.

Materials: See chart
Finish: Primer
Options: See chart for Corrosion Finish Options

Installation:

- Use all specified fasteners. See Product Notes, page 18.
- **Connectors are not load rated.**



Typical KHL35 installation

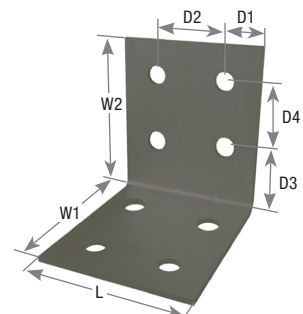

KHL55

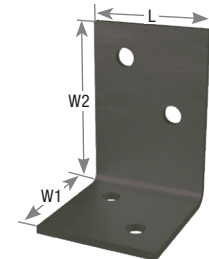

KHL335

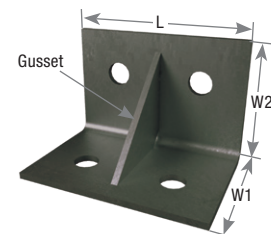

KHL35G

MiTek Stock No.	Ref. No.	Steel Gauge	Dimensions (in)							Fastener Schedule			Corrosion Finish	Code Ref.
			W1	W2	L	D1	D2	D3	D4	Bolts ¹		Gussets		
										Qty	Dia.			
KHL33	HL33	7	3-1/4	3-1/4	2-1/2	1-1/4	--	2	--	2	5/8	--		
KHL35	HL35	7	3-1/4	3-1/4	5	1-1/4	2-1/2	2	--	4	5/8	--		
KHL35G	HL35G	7	3-1/4	3-1/4	5	1-1/4	2-1/2	2	--	4	5/8	1		
KHL37	HL37	7	3-1/4	3-1/4	7-1/2	1-1/4	2-1/2	2	--	6	5/8	--		
KHL335	SPECANGLE	3	3-1/2	5-1/4	3-1/2	--	--	--	--	4	1/2	--		
KHL43	HL43	3	4-1/4	4-1/4	3	1-1/2	--	2-3/4	--	2	3/4	--		
KHL46	HL46	3	4-1/4	4-1/4	6	1-1/2	3	2-3/4	--	4	3/4	--		
KHL49	HL49	3	4-1/4	4-1/4	9	1-1/2	3	2-3/4	--	6	3/4	--		
KHL53	HL53	7	5-3/4	5-3/4	2-1/2	1-1/4	--	2	2-1/2	4	5/8	--		
KHL55	HL55	7	5-3/4	5-3/4	5	1-1/4	2-1/2	2	2-1/2	8	5/8	--		
KHL57	HL57	7	5-3/4	5-3/4	7-1/2	1-1/4	2-1/2	2	2-1/2	12	5/8	--		
KHL73	HL73	3	7-1/4	7-1/4	3	1-1/2	--	2-3/4	3	4	3/4	--		
KHL76	HL76	3	7-1/4	7-1/4	6	1-1/2	3	2-3/4	3	8	3/4	1		
KHL79	HL79	3	7-1/4	7-1/4	9	1-1/2	3	2-3/4	3	12	3/4	2		

1) All bolts shall meet or exceed the specifications of ASTM A 307.

Corrosion Finish Key ■ Stainless Steel ■ Gold Coat ■ HDG ■ Triple Zinc

ANJ Heavy Angles

Angles & Straps

The ANJ44S is a 7 gauge heavy duty angle intended to securely attach a post and beam together.

Materials: 7 gauge

Finish: Hot-dip galvanized

Installation:

- Install with (2) 1/2" x 2-1/2" HDG lag screws into each leg.

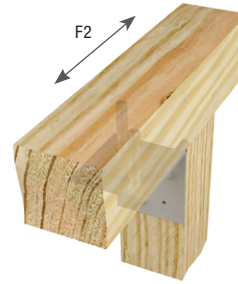

Typical ANJ44S-HDG installation

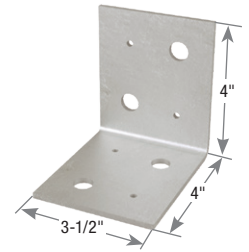

ANJ44S-HDG

MiTek Stock No.	Ref. No.	Steel Gauge	Dimensions (in)			Fastener Schedule ¹				DF/SP Allowable Loads (Lbs.)			Corrosion Finish	Code Ref.
			W	H	L	Header		Joist		F2				
						Qty	Lag Screw	Qty	Lag Screw	100%	115%	125%		
ANJ44S-HDG	--	7	3-1/2	4	4	2	1/2" HDG	2	1/2" HDG	510	585	640		--

Corrosion Finish Key
■ Stainless Steel
■ Gold Coat
■ HDG
■ Triple Zinc

1) Loads based on use of (2) 1/2" x 2-1/2" lag screws, loaded parallel to grain, in Douglas Fir-Larch (G=0.50).

SCA Stair Angles

Stair angles simplify stair construction. There is no need to calculate and notch stair stringers. Stronger and safer than wood blocking, and the angle and fasteners are hidden from view.

Materials: 12 gauge

Finish: G-185 galvanizing

Installation:

- Use all specified fasteners. See Product Notes, page 18.
- MiTek WS15-EXT (1/4" dia. x 1-1/2" long) structural wood screws are not supplied with SCA angles.
- Use the SCA9-TZ for single 2x10 stair treads. Use the SCA10-TZ for double 2 x 6 stair treads.
- To calculate stair construction do the following:
 1. Find the number of steps needed by dividing the vertical drop in inches from the deck surface to grade by 7. Round off to the nearest whole number.
(Ex: Vertical drop of 39" divided by 7" equals 5.57 rounded off is 6)
 2. Find the step rise by dividing the vertical drop by the number of steps (39" divided by 6 = 6.5")
 3. Find the step run by measuring the depth of your tread board
(Ex: (2) 2x6s with 1/4" gap will have a run of 11-1/4")
 4. Find the stairway span by multiplying the run by the number of treads minus one (Ex: 11-1/4" x 5 = 56-1/4")
- Using the above calculations, mark stair angle locations on each stringer. Attach a stair angle to the inside of each stringer at the marked locations. Attach stringers to deck rim joist and railing posts. Position tread-boards on angles and fasten from below.



Typical SCA9-TZ installation

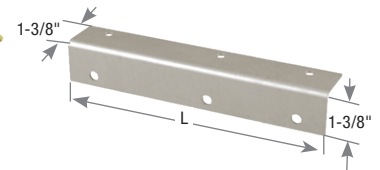

SCA9-TZ



Typical SCA10-TZ installation

AVAILABLE IN
GOLD COAT

MiTek Stock No.	Ref. No.	Steel Gauge	L (in)	Fastener Schedule ^{2,3}		DF/SP Allowable Loads (Lbs.) ¹	Corrosion Finish	Code Ref.
				Qty	Type			
SCA9-TZ	TA9Z	12	9	6	WS15-EXT	445		
SCA10-TZ	TA10Z	12	10	8	WS15-EXT	595		--

1) Loads assume rise over run of 7/11.

2) MiTek's WS15-EXT structural wood screws are 1/4" dia. x 1-1/2" long and are not included with SCA angles.

3) HDG lag screws may be substituted for specified MiTek WS15-EXT structural wood screws with no load reduction.

Corrosion Finish Key ■ Stainless Steel ■ Gold Coat ■ HDG ■ Triple Zinc

RSPT – 18 or 20 gauge

SPT – 20 gauge

TSP – 16 gauge. Optional diamond holes for various uplift capacities with Min and Max nailing configurations

Materials: See chart

Finish: G90 galvanizing

Options: See chart for Corrosion Finish Options

Codes: IBC, FL, LA

Installation:

- Use all specified fasteners. See Product Notes, page 18.
- TSP Min Nailing – Fill all round holes.
- TSP Max Nailing – Fill all round and diamond holes.
- HDG nails may be required when fastening to treated sill plates.

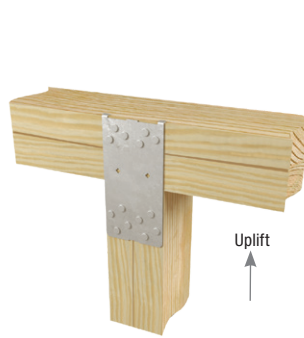

Typical RSPT6-2 installation



Typical RSPT4 single plate installation

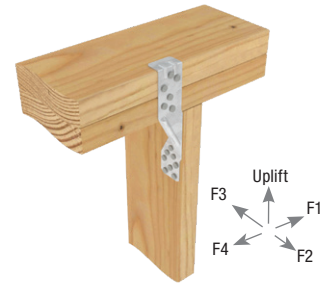

Typical TSP top plate installation (max nailing)

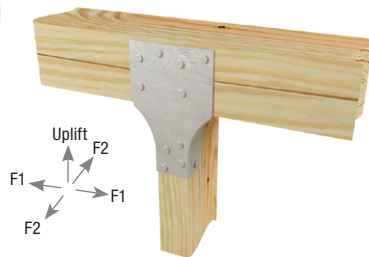

Typical SPT24 installation

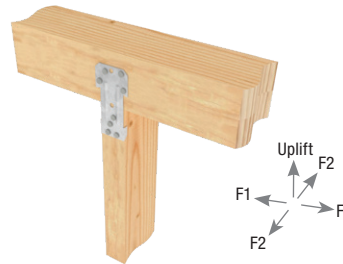

Typical RSPT4 double plate installation

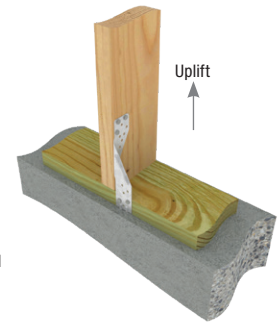

Typical TSP mudsill installation (min nailing)

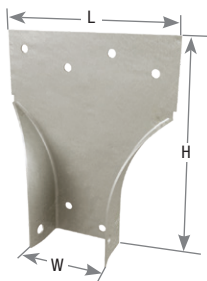

SPT22

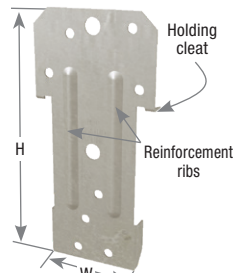

RSPT4



RSPT6



RSPT6-2

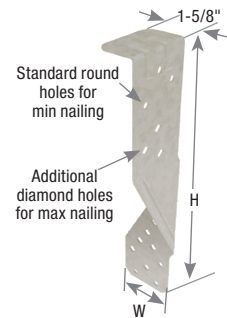

TSP

MiTek Stock No. ²	Ref. No.	Steel Gauge	Dimensions (in)			Fastener Schedule ³				DF/SP Allowable Loads (Lbs.)					Corrosion Finish	Code Ref.
						Stud		Plate		Uplift ¹	F1 160%	F2 160%	F3 160%	F4 160%		
			W	H	L	Qty	Type	Qty	Type							
RSPT4	RSP4	20	1-1/2	4-1/8	--	4	8d x 1-1/2	4	8d x 1-1/2	460	255	300	--	--		IBC, FL, LA
SPT22	SP1	20	1-9/16	4-3/8	3-1/2	4	10d	4	10d	735	535	275	--	--		
SPT24	SP2	20	1-9/16	5-5/8	3-1/2	6	10d	6	10d	1090	535	275	--	--		
SPT44	--	20	3-9/16	6-3/4	6-1/2	6	16d	6	16d	1315	845	275	--	--		
RSPT6	SSP	18	1-1/2	5-7/16	--	4	10d x 1-1/2	4	10d x 1-1/2	650	--	--	--	--		
RSPT6-2	DSP	18	2-3/4	5-7/16	--	8	10d x 1-1/2	6	10d x 1-1/2	900	--	--	--	--		
TSP	TSP	16	1-5/8	7-7/8	--	3	10d x 1-1/2	3	10d x 1-1/2	465	--	--	--	--		
						9	10d x 1-1/2	6	10d x 1-1/2	830	365	190	210	235		

1) Uplift loads have been increased 60% for wind or seismic loads; no further increase shall be permitted.
 2) SPT22, SPT24, and SPT44: the nails fastened to the wide face of the stud must be driven 30° from the perpendicular on the horizontal plane.
 3) NAILS: 8d x 1-1/2 nails are 0.131" dia. x 1-1/2" long, 10d x 1-1/2 nails are 0.148" dia. x 1-1/2" long, 10d nails are 0.148" dia. x 3" long, 16d nails are 0.162" dia. x 3-1/2" long.

Corrosion Finish Key
 ■ Stainless Steel ■ Gold Coat
 ■ HDG ■ Triple Zinc

SPT / SPTH / SPTHW Stud Plate Ties

Angles & Straps

- SPT** – 20 gauge. Ties single and double plates to studs
- SPTH** – Heavier 18 gauge version of SPT
- SPTHW** – 18 gauge. Attaches plate to studs over 1/2" sheathing
- Materials:** See chart
- Finish:** G90 galvanizing
- Options:** See chart for Corrosion Finish Options
- Codes:** IBC, FL, LA

- Installation:**
- Use all specified fasteners. See Product Notes, page 18.



Typical SPTHW installation



Typical SPT4 installation

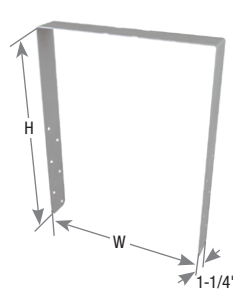

SPTHW

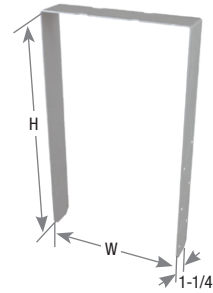

SPTH

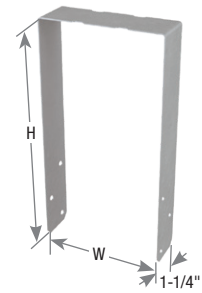

SPT

Stud Size	MiTek Stock No.	Ref. No.	Steel Gauge	Dimensions (in)		Fastener Schedule ²		DF/SP Allowable Loads (Lbs.)	Corrosion Finish	Code Ref.
				W	H	Qty	Type			
4x	SPT4	SP4	20	3-9/16	6-7/8	6	10d x 1-1/2	875	Green	IBC, FL, LA
	SPTH4	SPH4	18	3-9/16	8-5/8	12	10d x 1-1/2	2195		
	SPTHW4	SPH4R	18	4-1/16	8-3/8	12	10d x 1-1/2	2195		
6x	SPT6	SP6	20	5-9/16	7-5/8	6	10d x 1-1/2	875	Green	IBC, FL, LA
	SPTH6	SPH6	18	5-9/16	9-3/8	12	10d x 1-1/2	2195		
	SPTHW6	SPH6R	18	6-1/16	9-1/8	12	10d x 1-1/2	2195		
8x	SPT8	SP8	20	7-5/16	8-1/2	6	10d x 1-1/2	875	Green	IBC, FL, LA
	SPTH8	SPH8	18	7-5/16	8-1/2	12	10d x 1-1/2	2195		

1) Uplift loads have been increased 60% for wind or seismic loads; no further increase shall be permitted.
 2) **NAILS:** 10d x 1-1/2 nails are 0.148" dia. x 1-1/2" long.

Corrosion Finish Key ■ Stainless Steel ■ Gold Coat ■ HDG ■ Triple Zinc

SFC Framing Clips

Angles & Straps

Framing clips replace end cripples under window sills.

Materials: 16 gauge

Finish: G90 galvanizing

Installation:

- Use all specified fasteners. See Product Notes, page 18.

MiTek Stock No.	Ref. No.	Steel Gauge	Dimensions (in)			Fastener Schedule ²				DF/SP Allowable Loads (Lbs.) ¹				Code Ref.
			W	H	D	Sill		Stud		F1			Uplift	
						Qty	Type	Qty	Type	100%	115%	125%		
			100%	115%	125%	160%								
SFC6	--	16	5-1/2	2-1/2	2-1/2	5	16d	5	16d	690	795	865	750	--

1) Allowable loads have been increased 60% for wind or seismic loads; no further increase shall be permitted.

2) **NAILS:** 16d nails are 0.162" dia. x 3-1/2" long.

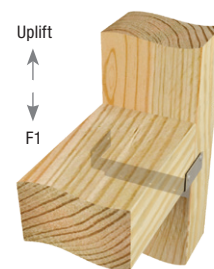

Typical SFC6 installation

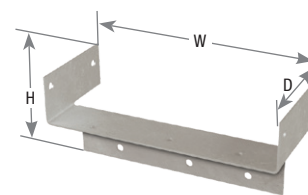

SFC6

HH Header Hangers

Header Hangers support headers in door and window framing and help eliminate cracks in drywall, plaster, or stucco over windows and doors. These products also provide anchorage and support for heavy fence rails, struts, or gate post cross brackets.

Materials: 16 gauge

Finish: G90 galvanizing

Codes: IBC, FL, LA

Installation:

- Use all specified fasteners. See Product Notes, page 18.

MiTek Stock No.	Ref. No.	Steel Gauge	Dimensions (in)		Fastener Schedule ²				DF/SP Allowable Loads (Lbs.)					Code Ref.	
			W	H	Header		Stud		F1			F2 ¹	F3 ¹		F4 ¹
					Qty	Type	Qty	Type	100%	115%	125%	160%	160%		160%
			100%	115%	125%	160%	160%	160%							
HH44	HH4	16	3-9/16	3-1/4	4	16d	9	16d	1325	1500	1620	835	895	1390	IBC,
HH66	HH6	16	5-1/2	5-1/4	6	16d	12	16d	1765	2000	2160	1025	1345	2400	FL, LA

1) Allowable loads have been increased 60% for wind or seismic loads; no further increase shall be permitted.

2) **NAILS:** 16d nails are 0.162" dia. x 3-1/2" long.

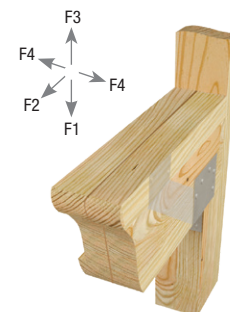

Typical HH44 installation

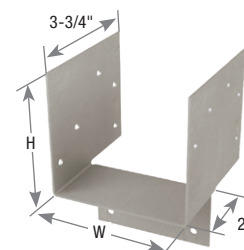

HH44

Copyright © 2022 MiTek Industries, Inc. All Rights Reserved

SDPT Strap Post Ties

Angles & Straps

Connects 2x4 stair posts and 4x4 posts to deck rim joist or stair stringers.

Materials: 14 gauge

Finish: G-185 galvanizing

Installation:

- Use all specified fasteners. See Product Notes, page 18.
- Install units in pairs on 2x4 (SDPT5-TZ) or 4x4 (SDPT7-TZ) post. Space the connectors 5" apart from center to center on the post. Use through bolts to fasten connectors to rim joist or stringer. Do not use lag bolts. Fasten to post with specified nails (see chart).

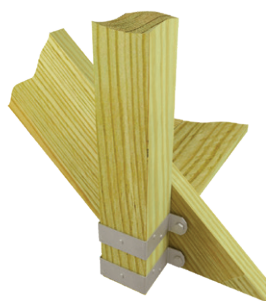

Typical SDPT7-TZ installation

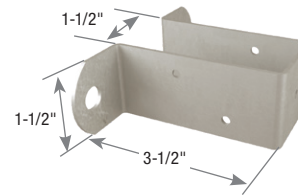

SDPT5-TZ

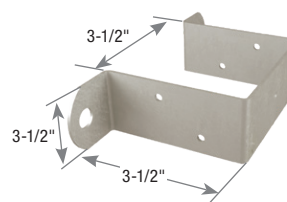

SDPT7-TZ

Post Size	MiTek Stock No.	Ref. No.	Steel Gauge	Fastener Schedule				Corrosion Finish	Code Ref.
				Nails ²		Bolts ¹			
				Qty	Type	Qty	Dia.		
2 x 4	SDPT5-TZ	DPT5Z	14	5	10d x 1-1/2 HDG	2	3/8 HDG		
4 x 4	SDPT7-TZ	DPT7Z	14	5	10d x 1-1/2 HDG	2	3/8 HDG		--

1) Bolts shall conform to ASTM A 307 or better.

2) **NAILS:** 10d x 1-1/2 nails are 0.148" dia. x 1-1/2" long.

Corrosion Finish Key ■ Stainless Steel ■ Gold Coat ■ HDG ■ Triple Zinc

SDJT Joist Tie

Secures 2x joists to posts.

Materials: 14 gauge

Finish: G-185 galvanizing

Installation:

- Use all specified fasteners. See Product Notes, page 18.
- Use with 2x lumber for joists (minimum height is 2x4). Install with either specified nails or through bolts. Do not use lag bolts. To ease installation, attach to 4x4 post first.



Typical SDJT14-TZ installation

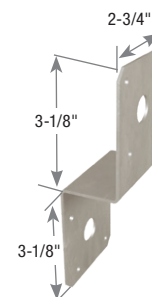

SDJT14-TZ

Post Size	MiTek Stock No.	Ref. No.	Steel Gauge	Fastener Schedule				DF/SP Allowable Loads (Lbs.)						Corrosion Finish	Code Ref.
				Nails ²		Bolts ¹		Nails			Bolts				
				Qty	Type	Qty	Dia.	100%	115%	125%	100%	115%	125%		
4 x 4	SDJT14-TZ	DJT14Z	14	8	16d HDG	2	3/8 HDG	1120	1290	1400	1400	1400	1400		--

1) Bolts shall conform to ASTM A 307 or better.

2) **NAILS:** 16d HDG nails are 0.162" dia. x 3-1/2" long.

Corrosion Finish Key ■ Stainless Steel ■ Gold Coat ■ HDG ■ Triple Zinc

LJC / LJQ Lateral Joist Connectors

Angles & Straps

The LJC-TZ and LJQ-TZ Lateral Joist Connectors transfer lateral loads at the top foundation to the floor joists. The fastening patterns meet I-joist manufacturer recommendations.

LJC-TZ – fastens the top side of the sill plate to the underside of the floor joist preventing splitting of the bottom chord flanges, and can be installed after the floor system has been installed. The product is load rated for use with dimensional lumber floor joists as well as I-joist. It can also be used with cantilevered floor joists.

LJQ-TZ – is a higher capacity connector designed for higher loads. It is similar in design to a joist hanger with a seat for the floor joist to bear against and utilizes wood screws to fasten to the sill plate. MiTek's WS15-EXT structural wood screws (included) provide quick installation without the need to predrill holes.

Materials: See chart

Finish: G-185 galvanizing

Installation:

- Use all specified fasteners. See Product Notes, page 18.
- **LJC-TZ** – Installs after the floor joist has been placed with a minimum of (12) 8d (0.131") x 1-1/2" HDG nails.
- **LJQ-TZ** – Installs with (4) MiTek WS15-EXT structural wood screws. WS15-EXT structural wood screws are 1/4" dia. x 1-1/2" long and are included with LJQ-TZ connectors.

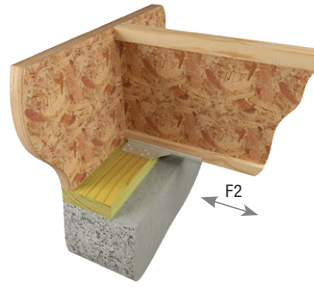

Typical LJC-TZ installation

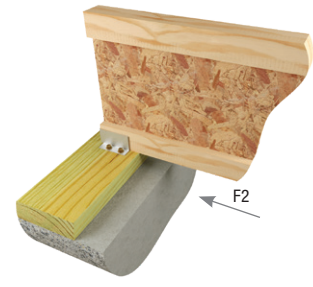

Typical LJQ-TZ installation

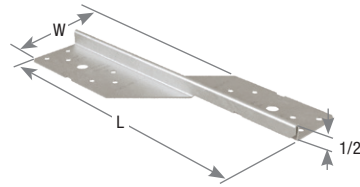

LJC-TZ

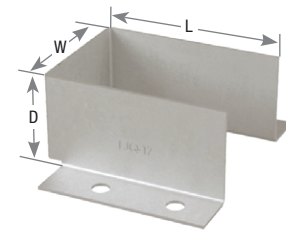

LJQ-TZ

MiTek Stock No.	Ref. No.	Steel Gauge	Dimensions (in)			Fastener Schedule ^{3,4}			SP Plate ^{1,2} Allowable Loads (Lbs.)			Corrosion Finish	Code Ref.
			W	L	D	Plate Qty	Joist Qty	Type	F2 90%	F2 100%	F2 160%		
LJC-TZ	--	18	3-3/16	8	--	6	6	8d x 1-1/2 HDG	515	570	670		--
LJQ35-TZ	--	16	3-9/16	3	1-1/2	4	--	WS15-EXT	915	1015	1260		--

- 1) LJC-TZ: DF Plate may be substituted for SP Plate with no load reduction.
- 2) Allowable loads apply to DF/SP dimensional lumber floor joists or EWP I-joists with DF or equivalent bottom chords.
- 3) MiTek's WS15-EXT structural wood screws are 1/4" dia. x 1-1/2" long and are included with LJQ35-TZ connector.
- 4) **NAILS:** 8d x 1-1/2 HDG nails are 0.131" dia. x 1-1/2" long.

Corrosion Finish Key ■ Stainless Steel ■ Gold Coat ■ HDG ■ Triple Zinc

HRS – 12 gauge, 1-3/8" or 3-1/4" wide strapping

LSTA – 20 or 18 gauge, light-capacity 1-1/4" wide strapping

LSTI – 3-3/4" wide strap ties provide tension load path for truss top chords. The nail pattern accommodates open web trusses with double top chord

MSTA – 18 or 16 gauge, medium-capacity 1-1/4" wide strapping

HTP – 16 gauge, medium-capacity 3" wide strapping

ST – 16 gauge, medium-capacity 1-1/4" wide strapping

MSTC – 3" wide strapping. Slotted hole design allows for higher load capacities and reduces splitting of lumber when attached to multiple 2x members

KST – 3/4", 1-3/4", or 2-1/16" wide strapping. Straps can be fastened using either nails or bolts. Some KST straps install only with nails

KSTI – 2-1/16" wide strapping. Straps are designed for installation to wood I-Joist flanges

Some model designs may vary from illustration shown

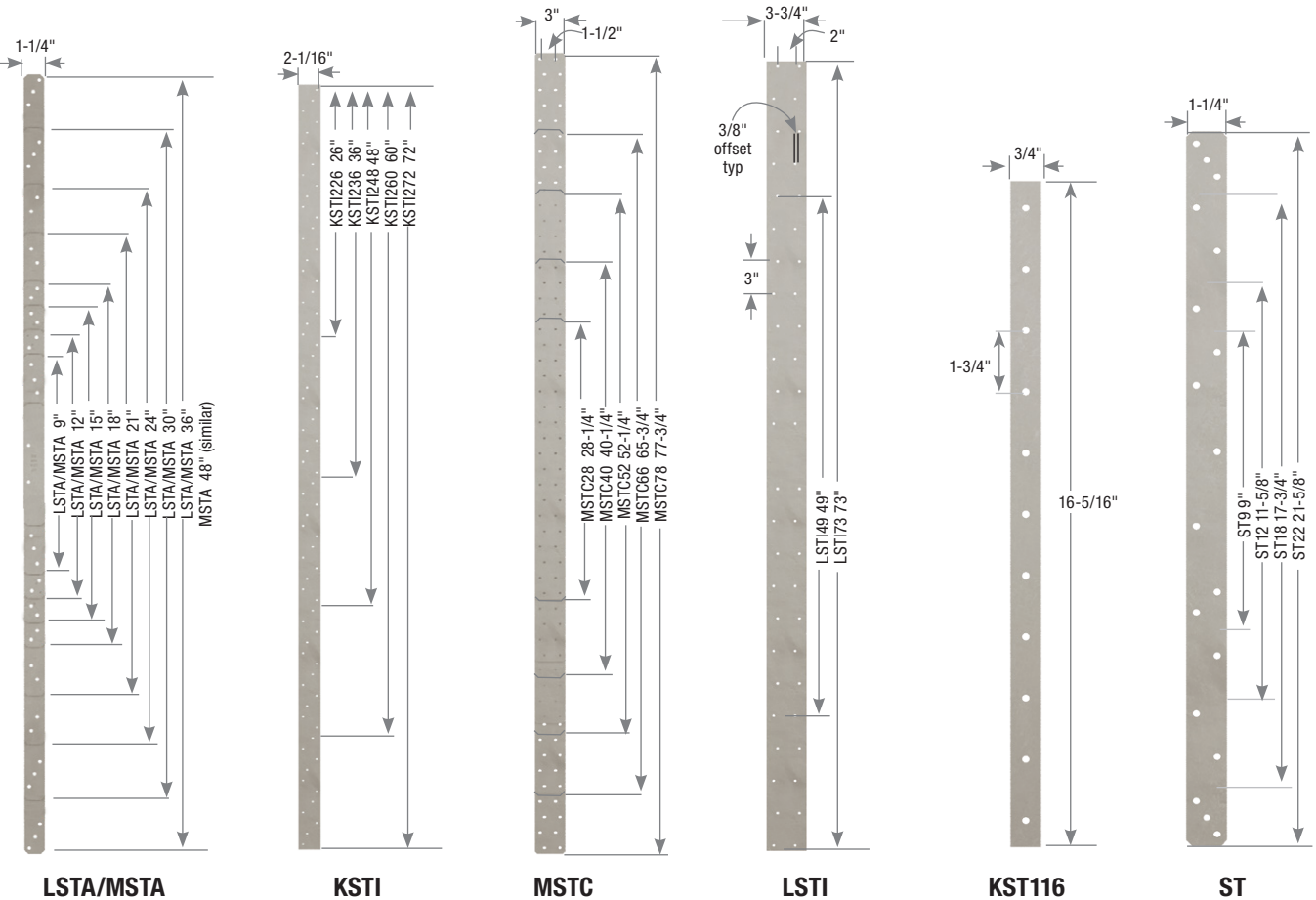
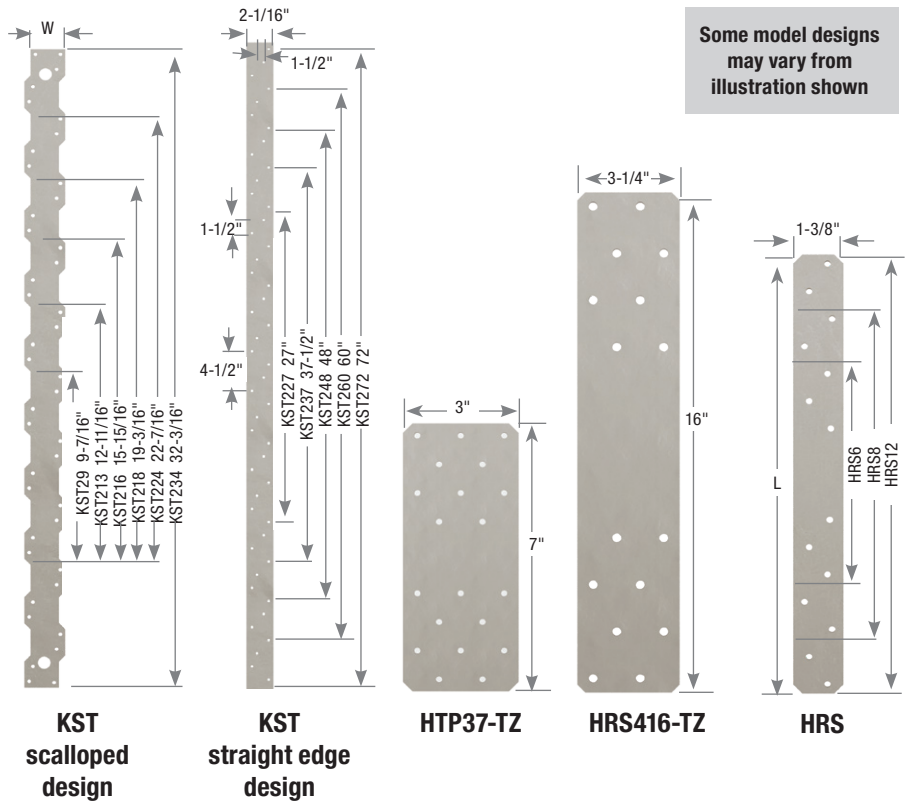

Continued on next page

Materials: See chart

Finish: G90 galvanizing

Options: See chart for Corrosion Finish Options

Codes: See chart for code references

Installation:

- Use all specified fasteners. See Product Notes, page 18.
- Designer may specify alternate nailing schedules. Refer to **Nail Specification Table** on page 23 for nail shear values.
- The quantity of nails installed shall be equally distributed to both ends of the strap.
- Unless specified otherwise by the panel manufacturer, straps may be installed over wood structural panels. Use full length nails of specified nail diameter to ensure adequate penetration into the main member is achieved (10 times the diameter minimum).

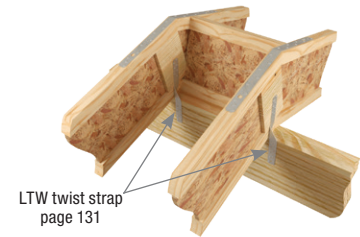

Typical LSTA/MSTA I-Joist on ridge beam installation



Typical LSTI open web truss installation

MiTek Stock No. ⁴	Ref. No.	Steel Gauge	Dimensions (in)		Fastener Schedule ⁵			DF/SP Allowable Tension Loads (Lbs.) ¹	S-P-F/HF Allowable Tension Loads (Lbs.) ¹	Corrosion Finish	Code Ref.
			W	L	Total Qty ²	Min Qty ³	Type	160%	160%		
KST116	ST2115	20	3/4	16-5/16	10	8	16d	665	665		
LSTA9	LSTA9	20	1-1/4	9	8	8	10d	740	635		
LSTA12	LSTA12	20	1-1/4	12	10	10	10d	930	790		
LSTA15	LSTA15	20	1-1/4	15	12	12	10d	1115	950		
LSTA18	LSTA18	20	1-1/4	18	14	14	10d	1235	1110		
LSTA21	LSTA21	20	1-1/4	21	16	16	10d	1235	1235		
LSTA24	LSTA24	20	1-1/4	24	18	18	10d	1235	1235		
KST29	ST292	20	1-3/4	9-7/16	14	14	16d	1545	1320		
KST213	ST2122	20	1-3/4	12-11/16	18	18	16d	1785	1700		
KST216	ST2215	20	1-3/4	15-15/16	22	18	16d	1785	1700		
LSTA30	LSTA30	18	1-1/4	30	22	22	10d	1640	1640		
LSTA36	LSTA36	18	1-1/4	36	26	22	10d	1640	1640		
MSTA9	MSTA9	18	1-1/4	9	8	8	10d	750	645		
MSTA12	MSTA12	18	1-1/4	12	10	10	10d	935	810		
MSTA15	MSTA15	18	1-1/4	15	12	12	10d	1125	970		
MSTA18	MSTA18	18	1-1/4	18	14	14	10d	1310	1130		
MSTA21	MSTA21	18	1-1/4	21	16	16	10d	1500	1295		
MSTA24	MSTA24	18	1-1/4	24	18	18	10d	1640	1455		
LSTI49	LSTI49	18	3-3/4	49	32	32	10d x 1-1/2	2970	2560		
LSTI73	LSTI73	18	3-3/4	73	48	48	10d x 1-1/2	4130	3840		
ST9	ST9	16	1-1/4	9	8	8	16d	895	775		
ST12	ST12	16	1-1/4	11-5/8	10	10	16d	1120	970		
ST18	ST18	16	1-1/4	17-3/4	14	14	16d	1570	1355		
ST22	ST22	16	1-1/4	21-5/8	18	18	16d	1705	1705		
MSTA30	MSTA30	16	1-1/4	30	22	22	10d	2065	1815		
MSTA36	MSTA36	16	1-1/4	36	26	26	10d	2065	2065		
MSTA48	MSTA49	16	1-1/4	48	32	26	10d	2045	2045		
KST218	ST6215	16	1-3/4	19-3/16	26	26	16d	2955	2540		
KST224	ST6224	16	1-3/4	22-7/16	30	30	16d	2960	2930		
HTP37-TZ	HTP37Z	16	3	7	20	20	10d x 1-1/2	1855	1600		--
MSTC28	MSTC28	16	3	28-1/4	36	36	10d	3455	2965		
					36	34	16d	3860	3320		
MSTC40	MSTC40	16	3	40-1/4	52	52	10d	4715	4285		
					52	46	16d	4715	4490		
MSTC52	MSTC52	16	3	52-1/4	70	60	10d	4715	4715		
					70	52	16d	4715	4715		
KST234	ST6236	14	1-3/4	32-3/16	42	36	16d	3775	3660		
MSTC66	MSTC66	14	3	65-3/4	88	72	10d	6015	6015		
					88	62	16d	6015	6015		
MSTC78	MSTC78	14	3	77-3/4	104	76	10d	6015	6015		
					104	66	16d	6015	6015		

Corrosion Finish Key

- Stainless Steel
- Gold Coat
- HDG
- Triple Zinc

1) Allowable loads have been increased 60% for wind or seismic loads; no further increase shall be permitted.

2) Total number of nail and/or bolt holes provided in the strap.

3) Minimum quantity of fasteners to be installed with equal fasteners at each end of the connection. Product may have additional nail holes not needed to meet published allowable load of product.

4) For MSTC straps: 16d sinker nails may be substituted for 10d nails with no reduction in load.

5) **NAILS:** 10d x 1-1/2 nails are 0.148" dia. x 1-1/2" long, 10d nails are 0.148" dia. x 3" long, 16d nails are 0.162" dia. x 3-1/2" long.

Continued on next page

MiTek Stock No.	Ref. No.	Steel Gauge	Dimensions (in)		Fastener Schedule ^{6,7}					DF/SP Allowable Tension Loads (Lbs.) ^{1,2}		S-P-F/HF Allowable Tension Loads (Lbs.) ^{1,2}		Corrosion Finish	Code Ref.
			W	L	Nails			Bolts		Nails	Bolts ⁵	Nails	Bolts ⁵		
					Total Qty ³	Min Qty ⁴	Type	Min Qty ⁴	Dia.						
			160%	160%	160%	160%									
HRS6	HRS6	12	1-3/8	6	6	6	10d	--	--	640	--	550	--		
HRS8	HRS8	12	1-3/8	8	10	10	10d	--	--	1065	--	920	--		--
HRS12	HRS12	12	1-3/8	12	14	14	10d	--	--	1490	--	1290	--		
KST227	MST27	12	2-1/16	27	34	34	16d	4	1/2	4215	2190	3645	2020		IBC, FL, LA
KST237	MST37	12	2-1/16	37-1/2	48	48	16d	6	1/2	5140	3105	5140	2875		
KST248	MST48	12	2-1/16	48	62	54	16d	8	1/2	5140	3825	5140	3555		
KSTI226	MSTI26	12	2-1/16	26	26	26	10d x 1-1/2	--	--	2765	--	2390	--		
KSTI236	MSTI36	12	2-1/16	36	36	36	10d x 1-1/2	--	--	3830	--	3310	--		
KSTI248	MSTI48	12	2-1/16	48	48	48	10d x 1-1/2	--	--	5105	--	4415	--		
KSTI260	MSTI60	12	2-1/16	60	60	60	10d x 1-1/2	--	--	5140	--	5140	--		
KSTI272	MSTI72	12	2-1/16	72	72	60	10d x 1-1/2	--	--	5140	--	5140	--		
HRS416-TZ	HRS416Z	12	3-1/4	16	16	16	WS15-EXT	--	--	2945	--	2410	--		--
KST260	MST60	10	2-1/16	60	72	64	16d	10	1/2	6720	4695	6720	4425		IBC,
KST272	MST72	10	2-1/16	72	72	64	16d	10	1/2	6720	4695	6720	4425		FL, LA

- 1) Allowable loads have been increased 60% for wind or seismic loads; no further increase shall be permitted.
- 2) Allowable loads are based on the use of either nails or bolts; nail and bolt values cannot be combined.
- 3) Total number of nail and/or bolt holes provided in the strap.
- 4) Minimum quantity of fasteners to be installed with equal quantity of fasteners at each end of the connection. Product may have additional nail holes not needed to meet published allowable load of product.
- 5) Allowable bolt loads are based on parallel-to-grain loading, minimum of 2-1/2" thick.
- 6) MiTek's WS15-EXT structural wood screws are 1/4" dia. x 1-1/2" long.
- 7) **NAILS:** 10d x 1-1/2 nails are 0.148" dia. x 1-1/2" long, 10d nails are 0.148" dia. x 3" long, 16d nails are 0.162" dia. x 3-1/2" long.

Corrosion Finish Key

- Stainless Steel
- Gold Coat
- HDG
- Triple Zinc

Clear Span Chart

MiTek Stock No.	Ref. No.	Clear Span	10d x 1-1/2 Fasteners ³		10d Fasteners ³		16d Fasteners ³	
			Total ² Qty	DF/SP	Total ² Qty	DF/SP	Total ² Qty	DF/SP
				Tension 160% ¹		Tension 160% ¹		Tension 160% ¹
MSTC28	MSTC28	18	--	--	12	1150	12	1365
		16			16	1535	14	1590
MSTC40	MSTC40	18	--	--	28	2690	24	2725
		16			32	3070	30	3410
MSTC52	MSTC52	18	--	--	44	4225	38	4315
		16			48	4610	42	4715
MSTC66	MSTC66	18	--	--	62	6015	54	6015
		16			64	6015	54	6015
MSTC78	MSTC78	18	--	--	64	6015	54	6015
		16			66	6015	56	6015
KST237	MST37	18	--	--	22	2340	20	2480
		16			24	2555	22	2730
KST248	MST48	18	--	--	34	3620	32	3970
		16			38	4045	34	4215
KST260	MST60	18	--	--	52	6115	46	6255
		16			54	6350	48	6530
KST272	MST72	18	--	--	52	6225	46	6255
		16			54	6350	48	6530
KSTI236	MSTI36	18	14	1410	--	--	--	--
		16	16	1615				
KSTI248	MSTI48	18	26	2620	--	--	--	--
		16	28	2820				
KSTI260	MSTI60	18	38	3830	--	--	--	--
		16	40	4030				
KSTI272	MSTI72	18	50	5040	--	--	--	--
		16	52	5240				

- 1) Allowable loads have been increased 60% for wind or seismic loads; no further increase shall be permitted.
- 2) Total quantity of nails used.
- 3) **NAILS:** 10d x 1-1/2 nails are 0.148" dia. x 1-1/2" long, 10d nails are 0.148" dia. x 3" long, 16d nails are 0.162" dia. x 3-1/2" long.

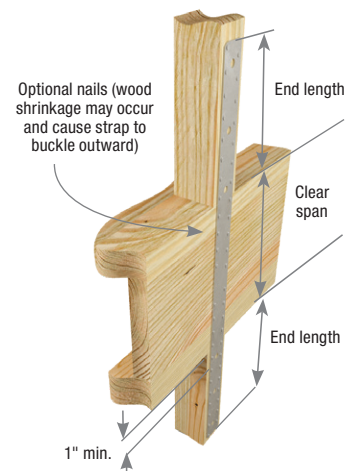

Typical KST237 floor-to-floor installation

KHST / KRPS / PS Strap Ties

Angles & Straps

KRPS – Meets IBC, IRC, & L.A. City requirements for notched plates where pipes placed in partitions

PS – Piling Straps connect wood pilings to floor girders. Hot-dip galvanized for corrosion protection in coastal environments

KHST – Heavy-capacity strap that utilizes bolts

Materials: See chart

Finish: KHST – Primer; KRPS – G90 galvanizing; PS – Hot-dip galvanized

Options: See chart for Corrosion Finish Options

Codes: See chart for code references
IRC R602.6.1, IBC 2308.5.8

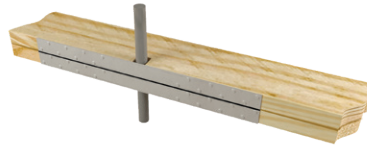

Typical KRPS installation

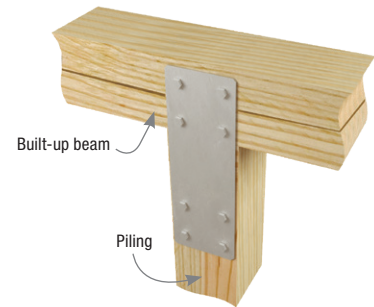

Typical PS720-HDG installation

Installation:

- Use all specified fasteners. See Product Notes, page 18.
- Install one strap tie for each 2x plate.

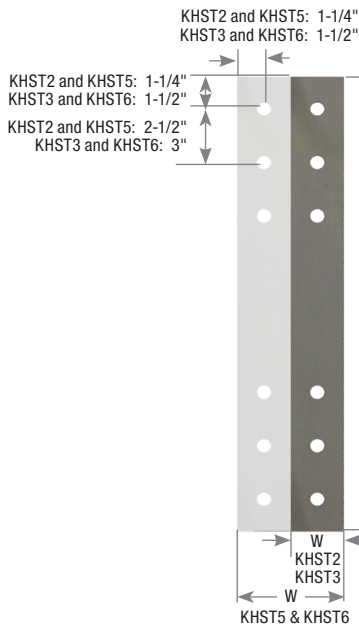

KHST

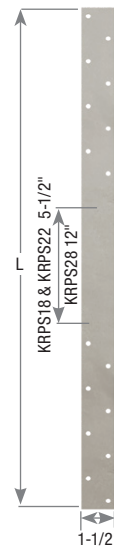

KRPS

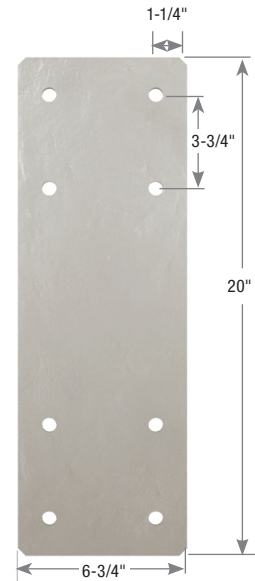

PS720-HDG

MiTek Stock No. ³	Ref. No.	Steel Gauge	Dimensions (in)		Notch Width (in)	Fastener Schedule ⁴				DF/SP Allowable Loads (Lbs.) ^{1,2}	Corrosion Finish	Code Ref.
			W	L		Nails		Bolts				
						Qty	Type	Qty	Type			
KHST2	HST2	7	2-1/2	21-1/4	--	--	6	5/8	5345		IBC, FL, LA	
KHST3	HST3	3	3	25-1/2	--	--	6	3/4	7920			
KHST5	HST5	7	5	21-1/4	--	--	12	5/8	10825			
KHST6	HST6	3	6	25-1/2	--	--	12	3/4	15935			
PS218-HDG	PS218	7	2	18	--	--	4	5/8	--			
PS418-HDG	PS418	7	4	18	--	--	4	5/8	--		--	
PS720-HDG	PS720	7	6-3/4	20	--	--	8	5/8	--			
KRPS18	RPS18	16	1-1/2	18-5/16	≤ 5-1/2	12	16d	--	1345		IBC, FL, LA	
KRPS22	RPS22	16	1-1/2	22-5/16	≤ 5-1/2	12	16d	--	1345		IBC, FL	
						16	16d	--	1790		IBC, FL, LA	
KRPS28	RPS28	16	1-1/2	28-5/16	≤ 12	12	16d	--	1345		IBC, FL	
						16	16d	--	1790		IBC, FL, LA	

1) Allowable loads have been increased 60% for wind or seismic loads; no further increase shall be permitted.
 2) Allowable loads are based on single shear, parallel to grain loading with a 3-1/2" minimum member thickness for KHST2 and KHST5, and 4-1/2" minimum member thickness for KHST3 and KHST6.
 3) PS piling strap design loads must be determined for each installation. Bolts are installed perpendicular and parallel-to-grain.
 4) **NAILS:** 16d nails are 0.162" dia. x 3-1/2" long.

Corrosion Finish Key ■ Stainless Steel ■ Gold Coat ■ HDG ■ Triple Zinc



PS218-HDG
PS418-HDG similar

Copyright © 2022 MiTek Industries, Inc. All Rights Reserved

Angles & Straps

L / LH / T / TH Straps

Angles & Straps

L / T – 14 gauge medium-capacity straps fasten with either nails or bolts

LH / TH – 7 gauge heavy-capacity bolt-on strap

Materials: See chart

Finish: G90 galvanizing; LH / TH – Primer; TH12-HDG – Hot-dip galvanized

Options: See chart for Corrosion Finish Options. Available for special order in black primer coated finish.

Installation:

- Use all specified fasteners. See Product Notes, page 18.
- **Straps are not load rated.**

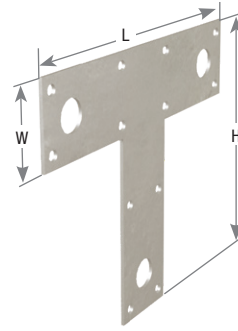

T6

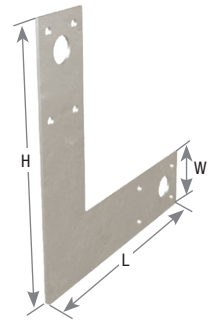

L6

MiTek Stock No.	Ref. No.	Steel Gauge	Dimensions (in)			Fastener Schedule ^{1,2}				Corrosion Finish	Code Ref.
			W	H	L	Bolts		Nails			
						Qty	Dia.	Qty	Type		
T6	66T	14	1-1/2	5	6	3	1/2	12	16d		
T8	--	14	2	8	8-1/2	3	1/2	12	16d		
T12	128T	14	2	8	12	3	1/2	12	16d		
T1212	1212T	14	2	12	12	3	1/2	12	16d		
L6	66L	14	1-1/2	6	6	2	1/2	8	16d		
L8	88L	14	2	8	8	2	1/2	8	16d		
L12	1212L	14	2	12	12	3	1/2	12	16d		
TH12-HDG	1212HT, 1212HTHDG	7	2-1/2	12	12	6	5/8	--	--		
TH16	1616HT	7	2-1/2	16	16-1/4	6	5/8	--	--		
LH12	1212HL	7	3	12	12	5	5/8	--	--		
LH16	1616HL	7	2-1/2	16	16	7	5/8	--	--		

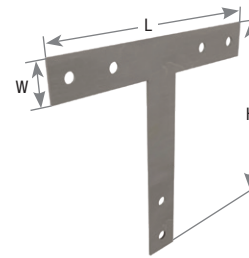

TH16

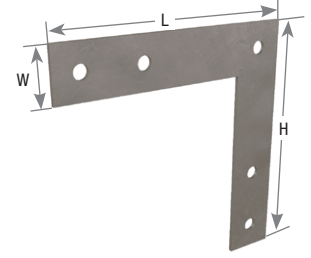

LH12

Corrosion Finish Key
■ Stainless Steel ■ Gold Coat
■ HDG ■ Triple Zinc

1) All bolts shall meet or exceed the specifications of ASTM A 307.
 2) **NAILS:** 16d nails are 0.162" dia. x 3-1/2" long.

Ornamental

Ornamental notching provides architectural appearance for exposed applications.

Materials: See chart

Finish: Black primer

Installation:

- Use all specified fasteners. See Product Notes, page 18.
- **Connectors are not load rated.**

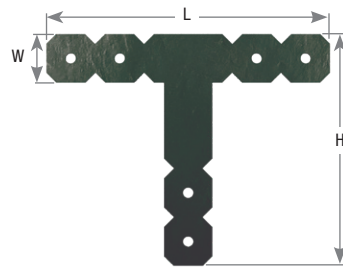

T1212-0

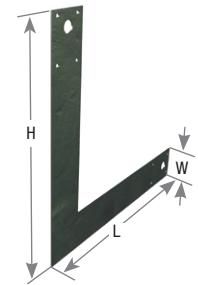

L12-0

MiTek Stock No.	Ref. No.	Steel Gauge	Description	Dimensions (in)			Bolt Schedule ¹		Code Ref.
				W	H	L	Qty	Dia.	
KHL33-0	OHA33	7	Heavy Angle	3-1/4	--	2-1/2	2	5/8	
KHL36-0	OHA36	7	Heavy Angle	3-1/4	--	6	4	5/8	
KHST64-0	OHS135	7	Strap Tie	6	--	13-1/2	4	3/4	
ST12-0	OS	12	Strap Tie	2	--	12	4	1/2	
L12-0	OL	12	'L' Strap	2-1/2	11-7/8	11-7/8	5	1/2	--
LH12-0	OHL	7	'L' Strap	2-1/2	11-7/8	11-7/8	5	5/8	
T1212-0	OT	12	'T' Strap	2-1/2	11-7/8	14-1/2	6	1/2	
TH12-0	OHT	7	'T' Strap	2-1/2	11-7/8	11-1/8	4	5/8	
TH16-0	--	7	'T' Strap	2-1/2	11-7/8	16-1/8	6	5/8	

1) All bolts shall meet or exceed the specifications of ASTM A 307.

Some model designs may vary from illustration shown

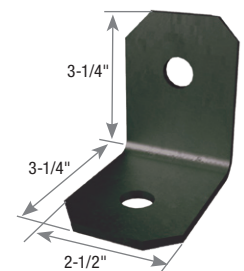

KHL33-0

Coiled strapping enables cut-to-length convenience for a variety of immediate job site needs.

CMST – 3" wide strapping features diamond nail holes to provide nailing options and reduce wood splitting

CMSTC – 3" wide strapping is designed for high load conditions. Engineered to reduce wood splitting

RS – 1-1/4" wide strapping packaged in cartons containing 25-foot or longer coils

Materials: See chart

Finish: G90 galvanizing

Options: See chart for Corrosion Finish Options and Strap Lap Splice information on page 127

Codes: IBC, FL, LA

Installation:

- Use all specified fasteners. See Product Notes, page 18.
- For safety, always wear gloves when handling or cutting coiled strapping.
- **CMST/CMSTC** installations: Install to a minimum 2-ply 2x edge. Increase nail spacing if wood begins to split.
- Designer may specify alternate nailing schedules. Refer to **Nail Specification Table** on page 23 for nail shear values. Load values shall not exceed published allowable loads.
- Unless specified otherwise by the panel manufacturer, straps may be installed over wood structural panels. Use full length nails of specified nail diameter to ensure adequate penetration into the main member is achieved (10 times the diameter minimum).

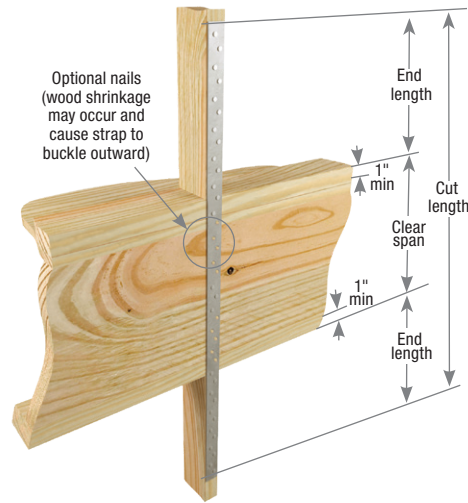

Typical RS rim joist installation

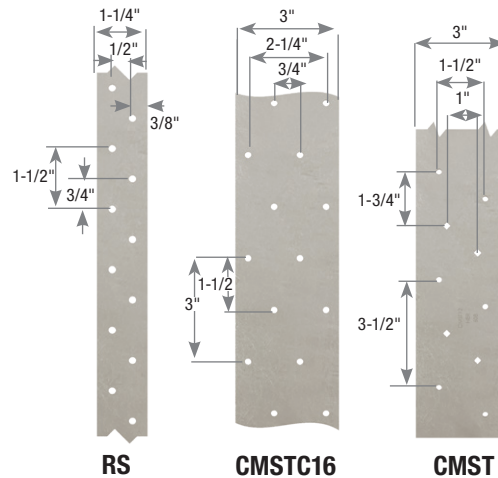

MiTek Stock No.	Ref. No.	Steel Gauge	Coil Length	DF/SP					S-P-F / Hem Fir					Code Ref.		
				Rim Joist Installation		Fastener Schedule ^{3,4}		Nail Spacing O.C.	Allowable Tension (Lbs.) ¹ 160%	Rim Joist Installation		Fastener Schedule ^{3,4}			Nail Spacing O.C.	Allowable Tension (Lbs.) ¹ 160%
				Cut Length	End Length	Min Qty. ²	Type			Cut Length	End Length	Min Qty. ²	Type			
CMSTC16	CMSTC16	16	54'	Clear Span + 46"	23"	60	10d	1-1/2"	4715	Clear Span + 58"	29"	74	10d	1-1/2"	4715	IBC, FL, LA
				Clear Span + 90"	45"	60	10d	3"		Clear Span + 112"	56"	74	10d	3"		
				Clear Span + 40"	20"	50	16d	1-1/2"		Clear Span + 48"	24"	62	16d	1-1/2"		
				Clear Span + 76"	38"	50	16d	3"		Clear Span + 94"	47"	62	16d	3"		
CMST14	CMST14	14	52-1/2'	Clear Span + 58"	29"	64	16d	1-3/4"	6630	Clear Span + 72"	36"	80	16d	1-3/4"	6630	
				Clear Span + 130"	65"	74	10d	3-1/2"		Clear Span + 164"	82"	94	10d	3-1/2"		
				Clear Span + 256"	128"	74	10d	7"		Clear Span + 326"	163"	94	10d	7"		
CMST12	CMST12	12	40'	Clear Span + 74"	37"	82	16d	1-3/4"	9320	Clear Span + 90"	45"	102	16d	1-3/4"	9320	
				Clear Span + 168"	84"	96	10d	3-1/2"		Clear Span + 206"	103"	118	10d	3-1/2"		
				Clear Span + 332"	166"	96	10d	7"		Clear Span + 410"	205"	118	10d	7"		
RS300	--	22	300'	Clear Span + 12"	6"	12	10d	1-1/2"	925	Clear Span + 14"	7"	16	10d	1-1/2"	925	
						14	8d	1-1/2"		Clear Span + 16"	8"	18	8d	1-1/2"		
RS22-R	--					25'	12	10d		1-1/2"	Clear Span + 14"	7"	16	10d		1-1/2"
							14	8d		1-1/2"	Clear Span + 16"	8"	18	8d		1-1/2"

1) Allowable loads have been increased 60% for wind or seismic loads; no further increase shall be permitted.
 2) Minimum quantity of fasteners to be installed with equal fasteners at each end of the connection. Fasteners must be installed a minimum 1" distance from the end of the studs. Product may have additional nail holes not needed to meet published allowable load.
 3) 16d sinker nails may be substituted for 10d nails with no load reduction.
 4) **NAILS:** 8d nails are 0.131" dia. x 2-1/2" long, 10d nails are 0.148" dia. x 3" long, 16d nails are 0.162" dia. x 3-1/2" long.

Continued on next page

MiTek Stock No.	Ref. No.	Steel Gauge	Coil Length	DF/SP					S-P-F / Hem Fir					Corrosion Finish	Code Ref.					
				Rim Joist Installation		Fastener Schedule ^{3,4}		Nail Spacing O.C.	Allowable Tension (Lbs.) ¹ 160%	Rim Joist Installation		Fastener Schedule ^{3,4}				Nail Spacing O.C.	Allowable Tension (Lbs.) ¹ 160%			
				Cut Length	End Length	Min Qty. ²	Type			Cut Length	End Length	Min Qty. ²	Type							
RS250	CS20	20	250'	Clear Span + 12"	6"	14	10d	1-1/2"	1045	Clear Span + 16"	8"	18	10d	1-1/2"	1045	IBC, FL, LA				
				Clear Span + 14"	7"	16	8d	1-1/2"		Clear Span + 18"	9"	20	8d	1-1/2"						
RS20-R	CS20-R		25'	Clear Span + 12"	6"	14	10d	1-1/2"		Clear Span + 16"	8"	18	10d	1-1/2"						
				Clear Span + 14"	7"	16	8d	1-1/2"		Clear Span + 18"	9"	20	8d	1-1/2"						
RS200	--	18	200'	Clear Span + 16"	8"	18	10d	1-1/2"	1375	Clear Span + 18"	9"	22	10d	1-1/2"	1375					
				Clear Span + 18"	9"	22	8d	1-1/2"		Clear Span + 22"	11"	26	8d	1-1/2"						
RS100	--		100'	Clear Span + 16"	8"	18	10d	1-1/2"		Clear Span + 18"	9"	22	10d	1-1/2"						
				Clear Span + 18"	9"	22	8d	1-1/2"		Clear Span + 22"	11"	26	8d	1-1/2"						
RS18-R	--		25'	Clear Span + 16"	8"	18	10d	1-1/2"		Clear Span + 18"	9"	22	10d	1-1/2"						
				Clear Span + 18"	9"	22	8d	1-1/2"		Clear Span + 22"	11"	26	8d	1-1/2"						
RS150	CS16		16	150'	Clear Span + 18"	9"	22	10d		1-1/2"	1730	Clear Span + 24"	12"	28		10d		1-1/2"	1730	
					Clear Span + 22"	11"	26	8d		1-1/2"		Clear Span + 26"	13"	32		8d		1-1/2"		
RS16-R	CS16-R	25'		Clear Span + 18"	9"	22	10d	1-1/2"	Clear Span + 24"	12"		28	10d	1-1/2"						
				Clear Span + 22"	11"	26	8d	1-1/2"	Clear Span + 26"	13"		32	8d	1-1/2"						
RS14-100	CS14	14	100'	Clear Span + 24"	12"	28	10d	1-1/2"	2610	Clear Span + 30"	15"	36	10d	1-1/2"	2610					
				Clear Span + 28"	14"	34	8d	1-1/2"		Clear Span + 34"	17"	42	8d	1-1/2"						
RS14-R	CS14-R		25'	Clear Span + 24"	12"	28	10d	1-1/2"		Clear Span + 30"	15"	36	10d	1-1/2"						
				Clear Span + 28"	14"	34	8d	1-1/2"		Clear Span + 34"	17"	42	8d	1-1/2"						

- 1) Allowable loads have been increased 60% for wind or seismic loads; no further increase shall be permitted.
- 2) Minimum quantity of fasteners to be installed with equal fasteners at each end of the connection. Fasteners must be installed a minimum 1" distance from the end of the studs. Product may have additional nail holes not needed to meet published allowable load.
- 3) 16d sinker nails may be substituted for 10d nails with no load reduction.
- 4) **NAILS:** 8d nails are 0.131" dia. x 2-1/2" long, 10d nails are 0.148" dia. x 3" long.

Corrosion Finish Key
■ Stainless Steel ■ Gold Coat
■ HDG ■ Triple Zinc

Strap Lap Splice Table

Multiple straps can be used as a single tension member by overlapping the straps and aligning the fastener holes. See table below for minimum splice length and fasteners needed to transfer the straps maximum tensile capacity.

MiTek Stock No.	Steel Gauge	Fastener Type ³	Strap Lap Splice ²	
			Minimum Fasteners per Splice ¹	Minimum Splice Length (in)
CMST12	12	10d	33	30
		16d	27	25
CMST14	14	10d	23	21
		16d	20	19
CMSTC16	16	10d	17	14
		16d	14	11
RS150	16	8d	8	6
		10d	6	5

- 1) All fasteners must be installed in existing nail holes.
- 2) Minimum edge distance and end distance must be followed per applicable code.
- 3) **NAILS:** 8d nails are 0.131" dia. x 2-1/2" long, 10d nails are 0.148" dia. x 3" long, 16d nails are 0.162" dia. x 3-1/2" long.

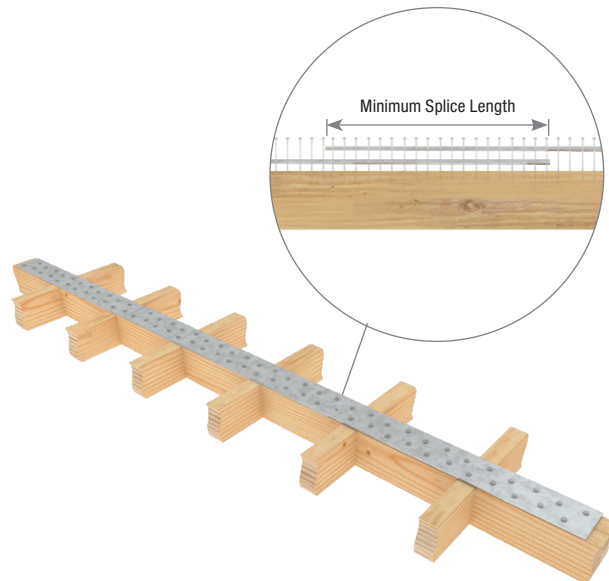

The MSTCB Pre-Bent Strap is designed to fasten vertical studs to a beam or ridge beam member below where the beam depth will not allow complete fastener attachments with a standard product.

Materials: 14 gauge

Finish: G90 galvanizing

Installation:

- Use all specified fasteners. See Product Notes, page 18.

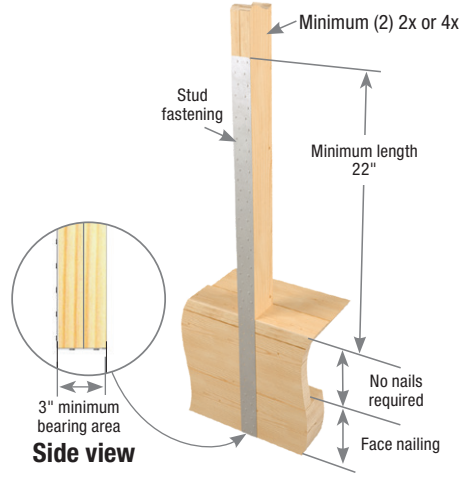

Typical MSTC66B3 installation

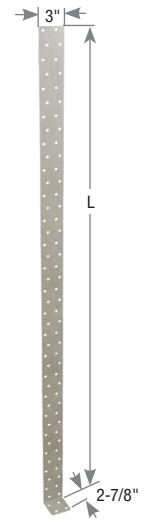

MSTCB

MiTek Stock No.	Ref. No.	GA	L (in)	Min. Beam Dimensions (in)		Fastener Schedule ⁵					DF/SP Allowable Loads (Lbs.) ¹	S-P-F Allowable Loads (Lbs.) ¹	Code Ref.
						Beam			Stud/Post ^{2,3,4}				
						Face Qty	Bottom Qty	Type	Qty	Type			
MSTC48B3	MSTC48B3	14	44-7/8	3	9-1/4	12	4	10d	24	10d	4800	3905	--
MSTC66B3	MSTC66B3	14	62-7/8	3	11-1/4	14	4	10d	28	10d	5375	4250	--

- 1) Allowable loads have been increased 60% for wind or seismic loads; no further increase shall be permitted.
- 2) The 3" wide beam may be 2-ply 2x member.
- 3) Fewer fasteners in the stud/post than listed will reduce the capacity of the connection.
- 4) Nails in the stud/post to be installed symmetrically in pairs starting a minimum of 1-1/2" from the end.
- 5) **NAILS:** 10d nails are 0.148" dia. x 3" long.

The HFS Hardy Frame® Saddle is a 14 gauge steel channel intended to be used as a splice at locations where plumbing or other vertical penetrations destroy the structural integrity of a wall's top plates.

Materials: 14 gauge
Finish: G60 galvanizing
Codes: IBC, FL, LA

Installation:

- Use all specified fasteners. See Product Notes, page 18.
- The Saddle can be installed over the top or from the underside of the top plates, and is capable of resisting both tension and compression loads in a clearspan of up to 4-1/2".
- For wall depths greater than 3-1/2", or to install after plumbing lines have been run, the product can be separated into two "L" shapes by gripping the legs of the channel and flexing the top surface along the serration lines.

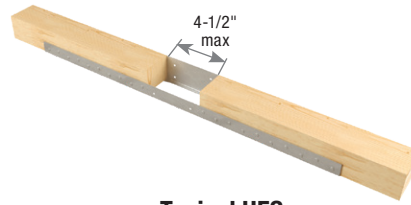

Typical HFS installation to underside of double top plates.

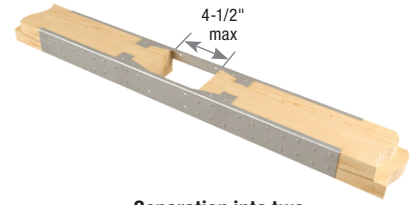

Separation into two "L" shapes at 6" and greater depths

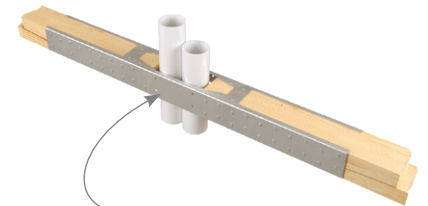

Omit fasteners at first holes when the end distance is less than 1"

MiTek Stock No.	Ref. No.	Steel Gauge	Dimensions (in)		Notch Width	Fastener Schedule		DF/SP Allowable Loads (Lbs.) ^{1,3}		S-P-F Allowable Loads (Lbs.) ^{1,3}		Code Ref.
			W	L		Qty ²	Type ⁴	Tension 100%	Compression 100%	Tension 100%	Compression 100%	
HFS24	--	14	3-5/8	24	≤ 4-1/2	24	16d	2950	2500	2537	2500	IBC, FL, LA
HFS36	--	14	3-5/8	36	≤ 4-1/2	32	16d	4280	2500	3681	2500	

- 1) Allowable tension loads are for normal duration. The values may be adjusted for other durations, such as for seismic and wind loading in accordance with the NDS.
- 2) Fastener quantity is the number of 16d common nails to be installed into each of the members to be joined. When the end distance from the joint to the first nail hole is less than 1", omit the (2) nails in the 3" side-plate and the (1) nail in the 1-1/2" side-plate that are nearest the joint.
- 3) There is no reduction in double top plate capacity provided the HFS24 is installed with minimum (22) 16d common nails in each member being joined (44 total) and the HFS36 is installed with (31) 16d common nails in each member (62 total).
- 4) **NAILS:** 16d nails are 0.162" dia. x 3-1/2" long.

Twist straps tie framing members to resist tension forces.

LFTA6 – 16 gauge

LTW – 18 gauge, light-capacity

MTW – 16 gauge, medium-capacity

KTS – 16 gauge, medium-capacity with angled twist

HTW – 14 gauge, heavy-capacity

Materials: See chart

Finish: G90 galvanizing

Options: See chart for Corrosion Finish Options

Codes: See chart for code references



Typical LTW12 / MTW12 truss-to-top plate installation



Typical LFTA6 stud-to-top plate installation



Typical LFTA6 truss-to-top plate installation

Installation:

- Use all specified fasteners. See Product Notes, page 18.
- Consult I-Joist manufacturer for web stiffener requirements, and uplift limitations on joist and application.

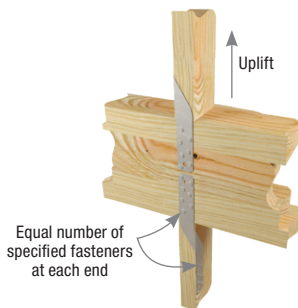

Typical LTW12 / MTW12 stud-to-rim joist installation

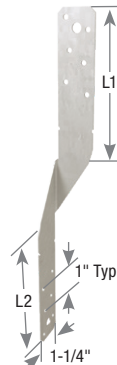

LTW12/MTW12

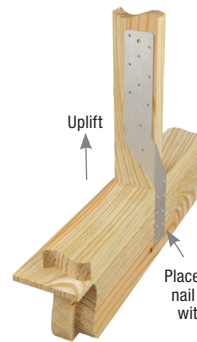

Typical LFTA6 stud-to-rim joist installation

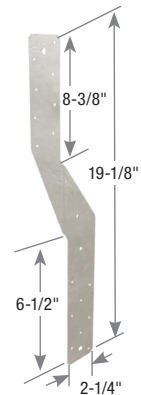

LFTA6



Typical MTW20 I-joist rafter installation



LTW18/MTW18
other models similar



Typical MTW30 installation

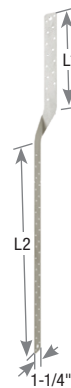

MTW30/HTW30

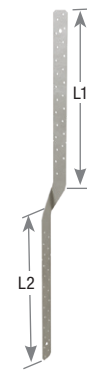

MTW30C



KTS

MiTek Stock No. ⁴	Ref. No.	Steel Gauge	Dimensions (in)				Fastener Schedule ^{2,3,6}		DF/SP Allowable Loads (Lbs.) ¹		S-P-F Allowable Loads (Lbs.) ¹		Corrosion Finish	Code Ref.
			W	L	L1	L2	Qty	Type	Uplift 160% ¹		Uplift 160% ¹			
									Stud-to-Rim Joist Installation	Truss-to-Top Plate Installation	Stud-to-Rim Joist Installation	Truss-to-Top Plate Installation		
LTW12	LTS12	18	1-1/4	12	4-1/2	4-1/2	12	10d x 1-1/2	770	625	650	525	Blue	IBC, FL, LA
							12	10d						
LTW16	LTS16	18	1-1/4	16	6-1/2	6-1/2	12	10d x 1-1/2	770	625	650	525	Blue	IBC, FL, LA
							12	10d						
LTW18	LTS18	18	1-1/4	18	7-1/2	7-1/2	12	10d x 1-1/2	770	625	650	525	Blue	IBC, FL, LA
							12	10d						
LTW20	LTS20	18	1-1/4	20	8-1/2	8-1/2	12	10d x 1-1/2	770	625	650	525	Blue	IBC, FL, LA
							12	10d						
KTS9	TS9	16	1-1/4	9	--	--	8	16d	785	785	660	660	Blue	--
KTS12	TS12	16	1-1/4	11-1/2	--	--	10	16d	1065	1065	895	895	Blue	--
MTW12	MTS12	16	1-1/4	12	4-1/2	4-1/2	14	10d x 1-1/2	1185	965	995	810	Green	IBC, FL, LA
							14	10d						
MTW16	MTS16	16	1-1/4	16	6-1/2	6-1/2	14	10d x 1-1/2	1185	965	995	810	Green	IBC, FL, LA
							14	10d						
KTS17	TS18	16	1-1/4	17-1/2	--	--	14	16d	1100	1100	925	925	Blue	--
MTW18	MTS18	16	1-1/4	18	7-1/2	7-1/2	14	10d x 1-1/2	1185	965	995	810	Blue	IBC, FL, LA
							14	10d						
LFTA6 ⁵	H6	16	2-1/4	19-1/8	8-3/8	6-1/2	16	8d	980	980	825	825	Green	IBC, FL, LA
							16	8d x 1-1/2						
MTW20	MTS20	16	1-1/4	20	8-1/2	8-1/2	14	10d x 1-1/2	1185	965	995	810	Blue	IBC, FL, LA
							14	10d						
KTS24	TS22	16	1-1/4	21-3/4	--	--	18	16d	1650	1650	1385	1385	Blue	--
MTW24C	MTS24C	16	1-1/4	24	10-7/16	10-7/16	14	10d x 1-1/2	1185	965	995	810	Blue	IBC, FL, LA
							14	10d						
MTW28C	--	16	1-1/4	28	12-7/16	12-7/16	14	10d x 1-1/2	1185	965	995	810	Blue	IBC, FL, LA
							14	10d						
MTW30	MTS30	16	1-1/4	30	8-5/16	18-9/16	14	10d x 1-1/2	1185	965	995	810	Green	IBC, FL, LA
							14	10d						
MTW30C	MTS30C	16	1-1/4	30	13-7/16	13-7/16	14	10d x 1-1/2	1185	965	995	810	Blue	IBC, FL, LA
							14	10d						
HTW16	HTS16	14	1-1/4	16	5-1/8	5-1/8	16	10d x 1-1/2	1115	1355	940	1140	Green	IBC, FL, LA
							16	10d			1090			
HTW20	HTS20	14	1-1/4	20	7-1/8	7-1/8	24	10d x 1-1/2	1555	1355	1305	1140	Blue	IBC, FL, LA
							20	10d			1140			
HTW24	HTS24	14	1-1/4	24	9-1/8	9-1/8	24	10d x 1-1/2	1555	1355	1305	1140	Blue	IBC, FL, LA
							20	10d			1140			
HTW28	--	14	1-1/4	28	11-1/8	11-1/8	24	10d x 1-1/2	1555	1355	1305	1140	Blue	IBC, FL, LA
							20	10d			1140			
HTW30	HTS30	14	1-1/4	30	7	17-1/4	24	10d x 1-1/2	1555	1355	1305	1140	Blue	IBC, FL, LA
							20	10d			1140			
HTW30C	HTS30C	14	1-1/4	30	12-1/8	12-1/8	24	10d x 1-1/2	1555	1355	1305	1140	Blue	IBC, FL, LA
							20	10d			1140			

Copyright © 2022 MiTek Industries, Inc. All Rights Reserved

1) Allowable loads have been increased 60% for wind or seismic loads; no further increase shall be permitted.
 2) 16d sinker nails may be substituted for 10d common nails with no reduction in load.
 3) Fasteners shall be distributed equally on each end of the connection.
 4) C after the model number designates center twist as in MTW30C.
 5) LFTA6: F1 is 745 lbs and F2 is 120 lbs. To achieve F1 lateral loads, three nails must be installed on each side on the strap located closest to the bend line. Lateral F1 and F2 load directions do not apply to roof truss-to-top plate installations.
 6) **NAILS:** 8d x 1-1/2 nails are 0.131" dia. x 1-1/2" long, 8d nails are 0.131" dia. x 2-1/2" long, 10d x 1-1/2 nails are 0.148" dia. x 1-1/2" long, 10d nails are 0.148" dia. x 3" long, 16d nails are 0.162" dia. x 3-1/2" long.

Corrosion Finish Key
 Blue Stainless Steel
 Orange Gold Coat
 Grey HDG
 Green Triple Zinc

The MSTAM and MSTCM Strap Ties are designed to connect a wood structure above to a masonry wall below.

Materials: See chart

Finish: G90 galvanizing

Options: See chart for Corrosion Finish Options

Codes: FL

Installation:

- Use all specified fasteners. See Product Notes, page 18.

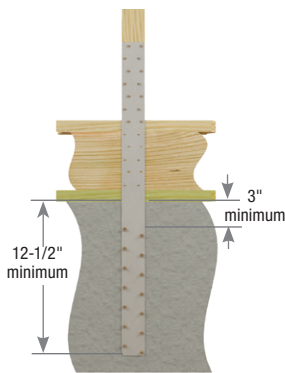

Typical MSTCM40 installation

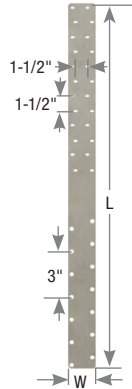

MSTCM40

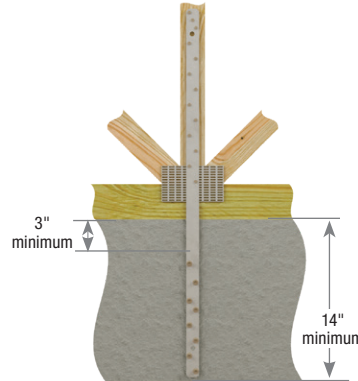

Typical MSTAM36 installation

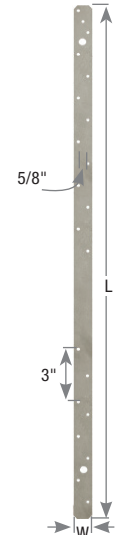

MSTAM36

MiTek Stock No.	Ref. No.	Steel Gauge	Dimensions (in)		Fastener Schedule				DF/SP Allowable Tension Loads (Lbs.) ^{1,2}	S-P-F Allowable Tension Loads (Lbs.) ^{1,2}	Corrosion Finish	Code Ref.
			W	L	CMU/Concrete Wall ³		Nails ⁴					
					Qty	Type	Qty	Type	160%	160%		
MSTAM24	MSTAM24	18	1-1/4	24	5	1/4" Tapcon	9	10d	1495	1455		
MSTAM36	MSTAM36	16	1-1/4	36	8	1/4" Tapcon	13	10d	1885	1885		
MSTCM40	MSTCM40	16	3	40-1/4	14	1/4" Tapcon	24	10d	4225	3955	FL	
							20	16d		3905		
MSTCM60	MSTCM60	16	3	60	14	1/4" Tapcon	24	10d	4225	3955		
							20	16d		3905		

Corrosion Finish Key

- Stainless Steel
- Gold Coat
- HDG
- Triple Zinc

- 1) Allowable loads have been increased 60% for wind or seismic loads; no further increase shall be permitted.
 - 2) Allowable loads are derived from tests performed using grout-filled hollow ASTM C90 concrete block.
 - 3) Use ITW Buildex 1/4" dia. x 2-1/4" long Tapcon fasteners; or equal, installed in accordance with manufacturer's specification.
 - 4) **NAILS:** 10d nails are 0.148" dia. x 3" long, 16d nails are 0.162" dia. x 3-1/2" long.
- New products or updated product information are designated in **blue font**.

Clear Span Chart

MiTek Stock No.	Clear Span	Fastener Schedule						DF/SP Allowable Tension Loads (Lbs.) ²	S-P-F Allowable Tension Loads (Lbs.) ²
		CMU ¹		Concrete ¹		Nails ³			
		Qty	Type	Qty	Type	Qty	Type	Tension 160%	Tension 160%
MSTAM36	16	5	1/4" Tapcon	5	1/4" Tapcon	8	10d	1305	1305
	18	5	1/4" Tapcon	5	1/4" Tapcon	7	10d	1305	1155
MSTCM40	16	12	1/4" Tapcon	12	1/4" Tapcon	16	16d	3135	3125
	18	12	1/4" Tapcon	12	1/4" Tapcon	14	16d	3135	2735
MSTCM60	16	14	1/4" Tapcon	12	1/4" Tapcon	20	16d	3660	3660
	18	14	1/4" Tapcon	12	1/4" Tapcon	20	16d	3660	3660

- 1) Use ITW Buildex 1/4" x 2-1/4" Tapcon fasteners; or equal, installed in accordance with manufacturer's specification.
- 2) Allowable loads are derived from tests performed using hollow ASTM C90 concrete block.
- 3) **NAILS:** 10d nails are 0.148" dia. x 3" long, 16d nails are 0.162" dia. x 3-1/2" long.

The HTWM Twist Straps are designed for truss to concrete or masonry connections. Offers uplift resistance with variable heel height and positioning applications.

Materials: 14 gauge
Finish: G90 galvanizing
Codes: FL

Installation:

- Use all specified fasteners. See Product Notes, page 18.
- Strap may be attached to either side of grouted masonry or concrete wall with a minimum of (1) #5 horizontal rebar.
- Drill hole in concrete or masonry with manufacturer's prescribed 1/4" masonry drill. Install fasteners into concrete or masonry per manufacturer's specification.
- Twist straps do not have to be wrapped over the truss to achieve the allowable loads.
- **Moisture barrier may be required.**

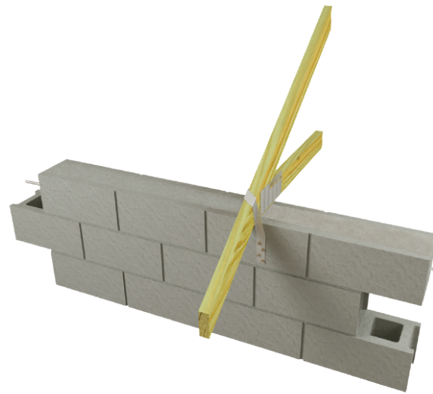

Typical HTWM installation

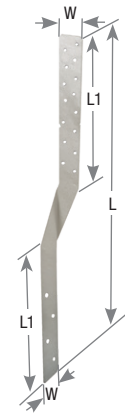

HTWM

MiTek Stock No.	Ref. No.	Steel Gauge	Dimensions (in)			Fastener Schedule				DF/SP Allowable Loads (Lbs.)	S-P-F Allowable Loads (Lbs.)	Code Ref.
			W	L	L1	CMU/Concrete Wall ⁴		Truss/Rafter				
						Qty	Screw Anchor ^{2,3}	Qty	Type ⁵	Uplift 160% ¹	Uplift 160% ¹	
HTWM16	HTSM16, MTSM16	14	1-1/4	16	5-3/4	4	1/4" x 1-3/4"	8	10d x 1-1/2	1225	1145	FL
HTWM20	HTSM20, MTSM20	14	1-1/4	20	7-3/4	4	1/4" x 1-3/4"	8	10d x 1-1/2	1225	1145	

1) Allowable loads have been increased 60% for wind or seismic loads; no further increase shall be permitted.
 2) Use DeWalt 1/4" x 1-3/4" Screw-Bolt™+; or equal, installed in accordance with manufacturer's specification.
 3) DeWalt 1/4" x 1-3/4" Screw-Bolt™+ are not supplied with HTWM straps. See page 45 for anchor information.
 4) Grout or concrete compressive strength shall be 2,500 psi or greater at 28 days.
 5) **NAILS:** 10d x 1-1/2 nails are 0.148" dia. x 1-1/2" long.

KSA – 12 gauge seismic horizontal tension tie

KHSA – 3 gauge. Designed for installation with bolts only

Materials: See chart

Finish: KSA – G90 galvanizing;
KHSA – Primer

Codes: IBC, FL, LA

Installation:

- Use all specified fasteners. See Product Notes, page 18.
- KSA36 can be field adjusted for smaller beam widths.

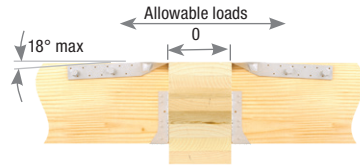

Typical KSA installation

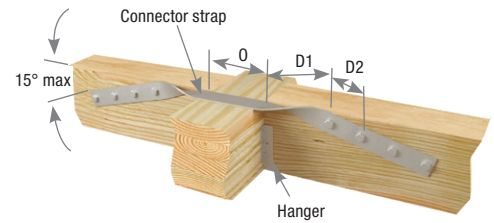

Typical KHSA4 installation



Typical KSA installation



KSA36

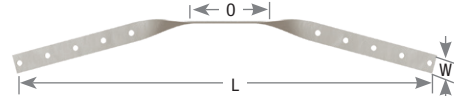

KHSA5

MiTek Stock No.	Ref. No.	Steel Gauge	Dimensions (in)					Fastener Schedule ^{3,4}		DF/SP Allowable Tension Loads (Lbs.) ^{1,2}	Code Ref.
			W	L	0	D1	D2	Qty	Type		
										160%	
KSA36	SA36	12	2-1/16	37-7/8	9	6-11/16	4-1/2	22	16d	2620	IBC, FL, LA
								4	1/2	2015	
KHSA1	--	3	3	30	9	10	--	2	3/4	2435	
KHSA2	--	3	3	38-1/2	9	10	4-1/2	4	3/4	4810	
KHSA3	--	3	3	47	9	10	4-1/2	6	3/4	7005	
KHSA4	--	3	3	56	9	10	4-1/2	8	3/4	8920	
KHSA5	--	3	3-1/2	64-1/2	9	10	4-1/2	10	3/4	10785	

- 1) Allowable loads are based on the use of either nails or bolts; nail and bolt values cannot be combined.
- 2) Bolt values assume wood member thickness of 3-1/2" with bolts in single shear.
- 3) Bolts shall be loaded parallel to grain.
- 4) **NAILS:** 16d nails are 0.162" dia. x 3-1/2" long.

KVB – Installs with MiTek’s WS3 structural wood screws for higher load capacity. It can be retrofit into existing framing

KVBI – Installs with common nails. Designed to be used with I-Joist purlins

Materials: 12 gauge
Finish: G90 galvanizing
Codes: IBC, FL, LA

Installation:

- Use all specified fasteners. See Product Notes, page 18.
- MiTek’s WS3 structural wood screws are included with KVB shipments.
- Install flanges at angles of 45° or more to the vertical plane to assure proper lateral resistance.

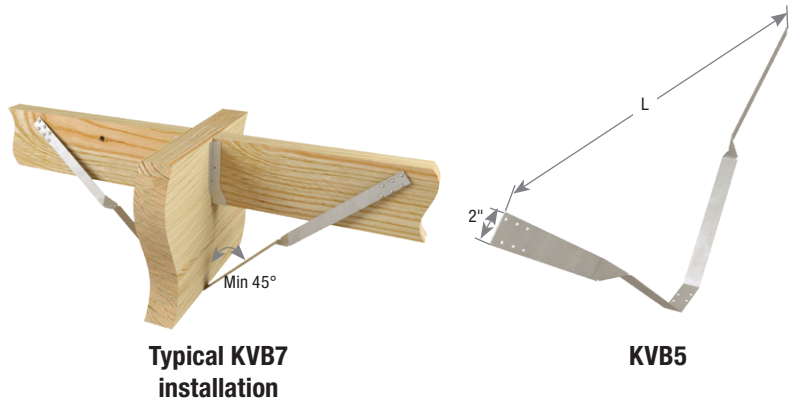

MiTek Stock No.	Ref. No.	Steel Gauge	Dimensions (in)		Fastener Schedule ^{1,2}				DF/SP Allowable Tension Loads (Lbs.)			Code Ref.
			Beam Depth	L	Beam		Joist		100%	125%	160%	
					Qty	Type	Qty	Type				
KVB5	VB5	12	10 - 15	60	4	WS3	12	WS3	1920	1920	1920	IBC, FL, LA
KVB7	VB7	12	15 - 22-1/2	84	4	WS3	12	WS3	1920	1920	1920	
KVB8	VB8	12	22-1/2 - 28-1/2	96	4	WS3	12	WS3	1920	1920	1920	
KVB10	VB10	12	28-1/2 - 36	120	4	WS3	12	WS3	1920	1920	1920	
KVB12	VB12	12	36 - 42	144	4	WS3	12	WS3	1920	1920	1920	
KVBI5	--	12	10 - 15	60	4	10d	12	10d	895	1060	1275	
KVBI7	--	12	15 - 22-1/2	84	6	10d	12	10d	895	1060	1275	
KVBI8	--	12	22-1/2 - 28-1/2	96	6	10d	12	10d	895	1060	1275	
KVBI10	--	12	28-1/2 - 36	120	6	10d	12	10d	895	1060	1275	
KVBI12	--	12	36 - 42	144	6	10d	12	10d	895	1060	1275	

1) MiTek’s WS3 structural wood screws are 1/4" dia. x 3" long and are included with specified KVB models.
 2) **NAILS:** 10d nails are 0.148" dia. x 3" long.

LUMBER HANGERS



LUMBER HANGERS

136-241

LUMBER HANGERS

138-193

Face Mount Hangers	139-165, 181-184
Hanger Selection Guide	138
Masonry Hangers	185-193
Panel & Purlin Hangers	177-181
Slope/Skew Hangers	173-176
Strap Hangers	172
Top Mount Hangers	166-171



FIRE WALL HANGERS

194-201

Top Mount Fire Wall Hangers	194-199
Face Mount Fire Wall Hangers	200-201



EWP HANGERS

202-231

Adjustable Connectors	230
EWP Hanger Selector Guide	204
EWP Installation	202-203
Face Mount Hangers	205-216
Top Mount Hangers	217-229
Slope/Skew Hangers	231



GLULAM BEAM HANGERS

232-241

Face Mount Hangers	232-234
Hinge Connectors	240-241
Seismic Straps	241
Top Mount Hangers	234-239

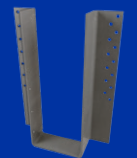

Hanger Type	MiTek Series	Steel Gauge	Style		Supporting / Header Member							Supported / Joist Member					Allowable Loads (Lbs.) Range		MiTek Series Catalog Page Reference			
			Formed	Welded	Beam/Joist/Rafter (rect shapes)	I-Joist	Truss (2x)	Floor Truss 4x	Nailer	Glulam	Wall	Post	Rim Joist	Beam/Joist/Rafter (rect shapes)	I-Joist	Truss (2x)	Floor Truss 4x	Glulam		Stringer	Header Material	
																					Masonry 100%	DF/SP 100%
Face Mount	JL	20	•	•	•	•			•			•	•	•					--	470 - 1,960	139, 142-143, 154-155	
	FB	18	•								•	•							--	315 - 330	184	
	JUS	18	•		•	•			•			•	•	•	•				--	675 - 2,420	140, 142-150, 154-162	
	CSH	18	•			•											•		--	890	181	
	MUS	18	•		•	•			•			•	•	•	•	•			--	1,285 - 1,710	140, 142-143, 154-155	
	JLIF	18	•		•	•					•	•		•					--	465 - 1,520	139, 142-143, 154-155	
	SUH	16	•		•	•			•			•	•	•					--	500 - 2,645	139, 142-151, 153-163, 165	
	HUS	16	•		•	•			•			•	•	•	•				--	850 - 5,580	140, 142-145, 149-150, 154-157, 161-162	
		14	•		•	•			•			•	•	•	•				--	850 - 5,580	140, 142-145, 149-150, 154-157, 161-162	
	HD	14	•		•	•			•		•	•	•	•	•	•			--	615 - 4,620	141-165	
	ADTT	14	•		•	•					•	•	•	•	•				--	790 - 850 ¹	182	
DTB	14	•		•	•			•			•	•	•					--	1835 ¹	183		
HDQIF	14	•		•	•			•		•	•	•	•	•	•			--	3,340 - 5,605	141, 144-152, 156-164		
Fire Wall	FWH	14	•	•	•	•	•	•	•	•	•	•	•	•	•	•	•	•	--	2,045 - 2,980	194-195	
	FWHBP	12	•	•	•	•	•	•	•	•	•	•	•	•	•	•	•	•	--	5,695 - 8,015	196-197	
	FWHFM	12	•	•	•	•	•	•	•	•	•	•	•	•	•	•	•	•	--	5,960	200-201	
	FWHH	12	•	•	•	•	•	•	•	•	•	•	•	•	•	•	•	•	--	6,005 - 7,355	198-199	
Top Mount	HL	18	•		•				•		•	•	•	•	•			--	1,255 - 1,490	166, 169		
	JH	18	•		•	•			•		•	•	•					--	1,910 - 2,555	172		
	KLB	14	•		•	•			•		•	•	•	•				--	1,670 - 2,140	166, 169		
	KB	12	•		•	•			•		•	•	•	•				--	4,075 - 4,795	166, 170-171		
	HDO	12	•		•	•			•		•	•	•	•				--	2,405 - 5,845	167, 169-171		
	SW	12	•		•	•			•		•	•	•	•				--	2,315 - 2,520	168-170		
	SWH	7 - Top Flange; 12 - Stirrup	•		•	•			•		•	•	•	•				--	3,305	168-171		
KHW	3 - Top Flange; 10 - Stirrup	•		•	•			•		•	•	•	•				--	5,295 - 5,535	168, 170-171			
Slope and Skew	RR	18	•		•	•	•	•	•		•	•	•					--	365 - 380	173		
	LS	18	•		•	•	•	•	•		•	•	•					--	840 - 1,285	173		
	LSSH	18	•		•	•	•	•	•		•	•	•	•	•	•	•	--	620 - 2,645	174		
		16	•		•	•	•	•	•		•	•	•	•	•	•	•	--	620 - 2,645	174		
	SKH	14	•		•	•	•	•	•		•	•	•	•				--	510 - 3,170	175-176		
SKHH	14	•		•	•	•	•	•		•	•	•	•				--	1,765 - 4,005	175-176			
Panel and Purlin	JPF	20	•		•	•	•	•	•		•	•	•					--	1,035	178		
	DTUS	20	•		•	•	•	•	•		•	•	•					--	485 - 580	180		
	TUS	20	•		•	•	•	•	•		•	•	•					--	485 - 580	180		
	KF	18	•		•	•	•	•	•		•	•	•					--	695 - 810	177		
	PHG	18	•		•	•	•	•	•		•	•	•					--	580 - 650	177		
	FHD	18	•		•	•	•	•	•		•	•	•					--	960	181		
	JDS	18	•		•	•	•	•	•		•	•	•					--	480 - 1,675	179		
Masonry	HD	14	•		•	•	•	•	•		•	•	•	•	•	•	•	•	335 - 5750	--	186	
	MPH	12	•		•	•	•	•	•		•	•	•	•	•	•	•	•	2,585 - 4,280	--	188-189	
	LGUM	12	•		•	•	•	•	•		•	•	•	•	•	•	•	•	6,065 - 9,905	--	187	
	HGUM	7	•		•	•	•	•	•		•	•	•	•	•	•	•	•	16,680	--	187	
	HWUH	1/4" - Top Flange; 7 - Stirrup	•		•	•	•	•	•		•	•	•	•	•	•	•	•	3,060 - 5,265	--	190-191	
	UMH	1/4"	•		•	•	•	•	•		•	•	•	•	•	•	•	•	3,550 - 6,380	--	185	
	NFM	3/8" - Top Flange; 7 - Stirrup	•		•	•	•	•	•		•	•	•	•	•	•	•	•	6,720 - 10,310	--	192-193	

• Represents common applications and product configurations. Consult MiTek for additional applications and/or optional product configurations.
 1) Allowable loads reflect DF/SP Tension 160%.
 2) When an I-Joist is used as a header, designer must evaluate if a web stiffener or backer block is required.
 New products or updated product information are designated in **blue font**.

Copyright © 2022 MiTek Industries, Inc. All Rights Reserved

MiTek offers a wide variety of light-gauge face mount joist hangers to accommodate application and installation preferences.

JL series – 20 gauge, 2x dimensional joist hangers

JLIF series – 18 gauge, 2x dimensional joist hangers. For installation at end of post or beam or where inverted flange is needed

SUH series – 16 gauge steel construction for more demanding applications and light truss support

Materials: See chart

Finish: G90 galvanizing; JLIF-G-185 galvanizing

Options: See chart for Corrosion Finish Options. See SUH Specialty Options Chart

Codes: IBC, FL, LA

Installation:

- Use all specified fasteners. See Product Notes, page 18.



Typical JL26 installation



Typical SUH26-2 installation

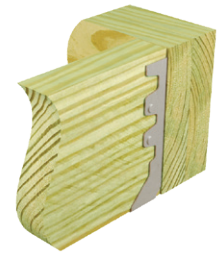

Typical JL210IF-TZ inverted flange installation

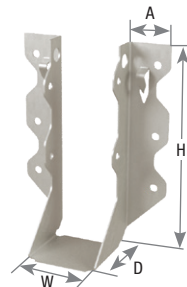

JL26

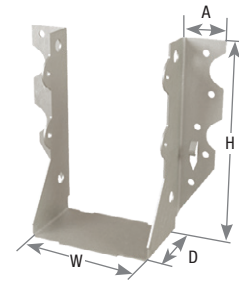

SUH26-2

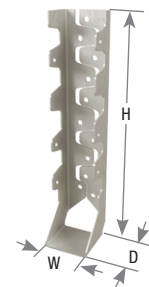

JLIF

SUH Specialty Options Chart

Refer to Specialty Options pages 320-321 for additional details.

Option ⁴	Skewed ^{1,3}	Sloped Seat ^{2,3}	Sloped / Skewed ^{1,2,3}
Range	1° to 67-1/2° when width is 1-3/4" or less. 1° to 50° on all others.	1° to 45°	See Sloped Seat and Skewed
Allowable Loads	100% of table load. 75% of uplift load on skews greater than 15°.	100% of table load	80% of table load. 75% of uplift load on skews greater than 15°.
Ordering	Add <i>SK</i> angle required, right (<i>R</i>) or left (<i>L</i>), and square cut (<i>SQ</i>) or bevel cut (<i>BV</i>) to product number. Ex. SUH210_SK45R_SQ	Add <i>SL</i> , slope required, and up (<i>U</i>) or down (<i>D</i>), to product number. Ex. SUH210_SL30D	See Sloped Seat and Skewed. Ex. SUH210_SK45R_SQ_SL30D

- 1) Skewed hangers with skews greater than 15° may have all joist nailing on outside flange.
- 2) Sloped or sloped / skewed hangers with slopes greater than 15° may have additional joist nails.
- 3) For skewed hangers, the required cut type (square or bevel) of joist member may vary based on skew angle and width of hanger. Some square cut hangers will require custom pricing due to welded back plate.
- 4) SUH option hangers may be manufactured as welded products to achieve listed loads. Welded products have a primer finish.

HUS / JUS / MUS Slant Nail Face Mount Joist Hangers

Lumber Hangers

The HUS, JUS and MUS hanger series offers double shear nailing. MiTek's dimple allows for 30° to 45° nailing through the joist into the header resulting in higher loads and less nailing. Slant nailing allows for higher load values, fewer nails, and faster installation.

Materials: JUS – 18 gauge; MUS – 18 gauge; HUS – 14 or 16 gauge

Finish: G90 galvanizing

Options: See chart for Corrosion Finish Options. See HUS Specialty Options Chart.

Codes: IBC, FL, LA

Installation:

- Use all specified fasteners. See Product Notes, page 18.
- Joist nails must be driven at a 30° to 45° angle through the joist or truss into the header to achieve listed loads. **Slant/double shear nails must be used to achieve listed load values.**
- JUS & MUS – 16d sinkers (0.148" x 3-1/4") may be used where 10d commons are specified with no load reduction.



Typical HUS46 installation



Typical JUS26 installation

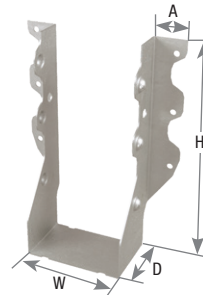

HUS28-2

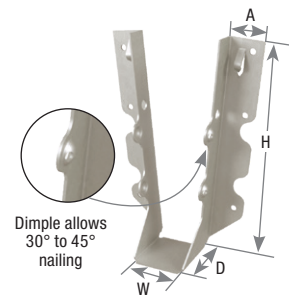

JUS28

AVAILABLE IN
**GOLD
COAT**

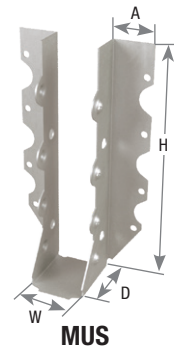

MUS

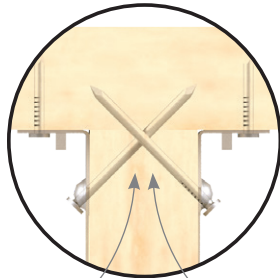

Double shear nail design features fewer nails and faster installation

Uses standard length common nails

HUS Specialty Options Chart

Refer to Specialty Options pages 320-321 for additional details.

Option	Inverted Flange
Range	Not available in widths less than 2-1/4".
Allowable Loads	100% of table load. 65% of table load when nailing into the support members end grain.
Ordering	Add <i>IF</i> to product number. Ex. HUS410_IF



Typical HUS410IF inverted flange installation

HD Heavy-Duty Face Mount Hangers

Lumber Hangers

HD hangers are heavy-duty face mount hangers utilizing round and diamond holes to achieve design flexibility and maximum loads for use with headers, joists, and trusses.

Materials: 14 gauge

Finish: G90 galvanizing

Options: See chart for Corrosion Finish Options. All nominal lumber sizes are available rough/full size lumber. See Specialty Options Chart

Codes: IBC, FL, LA

Installation:

- Use all specified fasteners. See Product Notes, page 18.
- **Min Nailing** – Fill all round nail holes.
- **Max Nailing** – Fill all round and diamond nail holes.
- 16d sinkers (0.148" dia. x 3-1/4" long) may be used at 0.84 of the table load where 16d commons are specified.



Typical HD610 installation



Typical HD210-2 installation



Typical HD3212 glulam installation

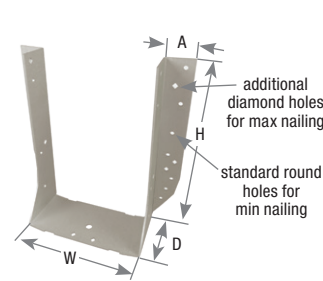

HD610

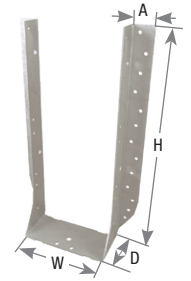

HD51135

Specialty Options Chart

Refer to Specialty Options pages 320-321 for additional details.

Option	Skewed ^{1,3}	Sloped Seat ^{2,3}	Sloped / Skewed ^{1,2,3}	Inverted Flange
Range	1° to 67-1/2° when width is 1-3/4" or less. 1° to 50° on all others.	1° to 45°	See Sloped Seat and Skewed	2-1/4" widths or greater (Widths < 2-1/4" may be available as a Custom, contact MiTek)
Allowable Loads	100% of table load. 75% of uplift load on skews greater than 15°.	100% of table load	80% of table load. 75% of uplift load on skews greater than 15°.	100% of table load. 65% of table load when nailing into the support members end grain.
Ordering	Add <i>SK</i> , angle required, right (<i>R</i>) or left (<i>L</i>), and square cut (<i>SQ</i>) or bevel cut (<i>BV</i>) to product number. Example: HD410_SK45R_SQ	Add <i>SL</i> , slope required, and up (<i>U</i>) or down (<i>D</i>), to product number. Example: HD410_SL30D	See Sloped Seat and Skewed Example: HD410_SK45R_SQ_SL30D	Add <i>IF</i> , to product number. Example: HD410_IF



Typical HD210-2IF inverted flange installation

- 1) Skewed hangers with skews greater than 15° may have all joist nailing on outside flange.
- 2) Sloped or sloped / skewed hangers with slopes greater than 15° may have additional joist nails.
- 3) For skewed hangers, the required cut type (square or bevel) of joist member may vary based on skew angle and width of hanger. Some square cut hangers will require custom pricing due to welded back plate.
- 4) HD option hangers may be manufactured as welded products to achieve listed loads. Welded products have a primer interior finish.

HDQIF Inverted Flange Face Mount Hangers

HDQIF inverted flange hangers install with wood screws eliminating the need to drill bolt holes, simplifying installation.

Materials: 14 gauge

Finish: G90 galvanizing

Options: See chart for Corrosion Finish Options

Codes: IBC, FL, LA

Installation:

- Use all specified fasteners. See Product Notes, page 18.
- MiTek's WS15 (1/4" dia. x 1-1/2" long) and WS3 (1/4" dia. x 3" long) structural wood screws are supplied with HDQIF hangers.



Typical HDQIF inverted flange installation

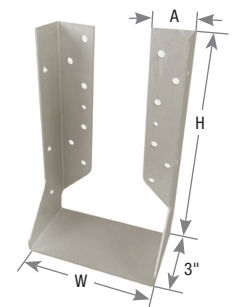

HDQIF

Joist Size	MiTek Stock No.	Ref. No.	Steel Gauge	Dimensions (in)				Fastener Schedule ³				DF/SP Allowable Loads (Lbs.) ²				Corrosion Finish	Code Ref.		
				W	H	D	A	Min/Max	Header		Joist		Floor		Roof			Uplift ¹	
									Qty	Type	Qty	Type	100%	115%	125%				160%
2 x 4	JL24	LU24	20	1-9/16	3	1-1/2	15/16	--	4	10d	2	10d x 1-1/2	470	540	580	295			
										16d			560	640	695				
	JL24IF-TZ	--	18	1-9/16	3-1/8	1-1/2	--	--	4	10d HDG	2	10d x 1-1/2 HDG	480	545	590	265			
										16d HDG			570	600	600				
	JUS24	LUS24	18	1-9/16	3-1/8	1-3/4	1	--	4	10d	2	10d	675	775	835	660			
2 x 6	SUH24	U24	16	1-9/16	3-1/4	2	1-3/16	--	4	10d	2	10d x 1-1/2	500	560	605	380			
										16d			590	665	720				
	HD26	HU26	14	1-9/16	3-1/2	2-1/2	1-1/8	Min	4	16d	2	10d x 1-1/2	615	695	745	335			
								Max	4		4					585			
	JL26	LU26	20	1-9/16	4-3/4	1-1/2	15/16	--	6	10d	4	10d x 1-1/2	710	805	870	600			
										16d			840	960	1045				
	JL26IF-TZ	LUC26Z	18	1-9/16	4-1/2	1-1/2	--	--	6	10d HDG	4	10d x 1-1/2 HDG	720	820	885	740			
										16d HDG			860	975	1060				
JUS26	LUS26	18	1-9/16	4-13/16	1-3/4	1	--	4	10d	4	10d	870	1000	1080	1050				
2 x 8	MUS26	MUS26	18	1-9/16	5-1/16	2	1	--	6	10d	6	10d	1310	1495	1620	865			
	SUH26	U26	16	1-9/16	5-1/8	2	1-3/16	--	6	10d	4	10d x 1-1/2	750	840	910	755			
										16d			880	1000	1080				
	HUS26	HUS26	16	1-5/8	5-7/16	3	2	--	14	16d	6	16d	2760	3140	3400	2045			
	HD26	HU26	14	1-9/16	3-1/2	2-1/2	1-1/8	Min	4	16d	2	10d x 1-1/2	615	695	745	335			
								Max	4		4					585			
	HD28	HU28	14	1-9/16	5-1/4	2-1/2	1-1/8	--	8	16d	6	10d x 1-1/2	1230	1390	1490	760			
	JL26	LU26	20	1-9/16	4-3/4	1-1/2	15/16	--	6	10d	4	10d x 1-1/2	710	805	870	600			
2 x 8										16d			840	960	1045				
	JL26IF-TZ	LUC26Z	18	1-9/16	4-1/2	1-1/2	--	--	6	10d HDG	4	10d x 1-1/2 HDG	720	820	885	740			
										16d HDG			860	975	1060				
	JL28	LU28	20	1-9/16	6-3/8	1-1/2	15/16	--	10	10d	6	10d x 1-1/2	1180	1345	1450	815			
										16d			1400	1600	1740				
	JL28IF-TZ	--	18	1-9/16	6-1/8	1-1/2	--	--	8	10d HDG	4	10d x 1-1/2 HDG	960	1095	1180	740			
										16d HDG			1145	1195	1195				
	JUS26	LUS26	18	1-9/16	4-13/16	1-3/4	1	--	4	10d	4	10d	870	1000	1080	1050			
	JUS28	LUS28	18	1-9/16	6-5/8	1-3/4	1	--	6	10d	4	10d	1110	1270	1375	1050			
	MUS26	MUS26	18	1-9/16	5-1/16	2	1	--	6	10d	6	10d	1310	1495	1620	865			
	MUS28	MUS28	18	1-9/16	7-1/16	2	1	--	8	10d	8	10d	1745	1995	2160	1230			
	SUH26	U26	16	1-9/16	5-1/8	2	1-3/16	--	6	10d	4	10d x 1-1/2	750	840	910	755			
										16d			880	1000	1080				
	SUH28	--	16	1-9/16	6-5/8	2	1-3/16	--	8	10d	6	10d x 1-1/2	1000	1120	1210	875			
									16d			1175	1335	1440					
HUS26	HUS26	16	1-5/8	5-7/16	3	2	--	14	16d	6	16d	2760	3140	3400	2045				
HUS28	HUS28	16	1-5/8	7-3/16	3	2	--	22	16d	8	16d	4170	4745	5125	2990				
HD28	HU28	14	1-9/16	5-1/4	2-1/2	1-1/8	--	8	16d	6	10d x 1-1/2	1230	1390	1490	760				
HD210	HU210	14	1-9/16	7-3/16	2-1/2	1-1/8	Min	10	16d	4	10d x 1-1/2	1540	1735	1865	760				
							Max	14		6		2155	2430	2610	1170				

IBC, FL, LA

Copyright © 2022 MiTek Industries, Inc. All Rights Reserved

1) Uplift loads have been increased 60% for wind or seismic loads; no further increase shall be permitted.
 2) For JUS, HUS, and MUS hangers: Nails must be driven at a 30° to 45° angle through the joist or truss into the header to achieve the table loads.
 3) **NAILS:** 10d x 1-1/2 nails are 0.148" dia. x 1-1/2" long, 10d nails are 0.148" dia. x 3" long, 16d nails are 0.162" dia. x 3-1/2" long.
 New products or updated product information are designated in **blue font**.

Corrosion Finish Key ■ Stainless Steel ■ Gold Coat ■ HDG ■ Triple Zinc

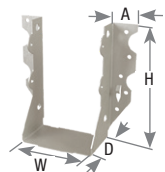

Continued on next page

Face Mount Hangers – DF/SP Allowable Loads

Lumber Hangers

Joist Size	MiTek Stock No.	Ref. No.	Steel Gauge	Dimensions (in)				Fastener Schedule ³				DF/SP Allowable Loads (Lbs.) ²				Corrosion Finish	Code Ref.		
				W	H	D	A	Min/Max	Header		Joist		Floor		Roof			Uplift ¹	
									Qty	Type	Qty	Type	100%	115%	125%				160%
2 x 10	JL28	LU28	20	1-9/16	6-3/8	1-1/2	15/16	--	10	10d	6	10d x 1-1/2	1180	1345	1450	815			
													1400	1600	1740				
	JL28IF-TZ	--	18	1-9/16	6-1/8	1-1/2	--	--	8	10d HDG	4	10d x 1-1/2 HDG	960	1095	1180	740			
													1145	1195	1195				
	JL210	LU210	20	1-9/16	8-1/4	1-1/2	15/16	--	14	10d	8	10d x 1-1/2	1650	1885	2030	1030			
													1960	2040	2040				
	JL210IF-TZ	LUC210Z	18	1-9/16	8-1/4	1-1/2	--	--	11	10d HDG	6	10d x 1-1/2 HDG	1320	1505	1625	1115			
													1575	1785	1940				
	JUS28	LUS28	18	1-9/16	6-5/8	1-3/4	1	--	6	10d	4	10d	1110	1270	1375	1050			
	JUS210	LUS210	18	1-9/16	7-3/4	1-3/4	1	--	8	10d	4	10d	1350	1545	1670	1050			
	MUS28	MUS28	18	1-9/16	7-1/16	2	1	--	8	10d	8	10d	1745	1995	2160	1230			
	SUH28	--	16	1-9/16	6-5/8	2	1-3/16	--	8	10d	6	10d x 1-1/2	1000	1120	1210	875			
												1175	1335	1440					
SUH210	U210	16	1-9/16	8	2	1-3/16	--	10	10d	6	10d x 1-1/2	1250	1405	1515	1135				
												1470	1670	1800					
HUS28	HUS28	16	1-5/8	7-3/16	3	2	--	22	16d	8	16d	4170	4745	5125	2990				
HUS210	HUS210	16	1-5/8	9-3/16	3	2	--	30	16d	10	16d	5455	5825	6060	4110				
HD210	HU210	14	1-9/16	7-3/16	2-1/2	1-1/8	Min	10	16d	4	10d x 1-1/2	1540	1735	1865	760				
							Max	14		6		2155	2430	2610	1170				
2 x 12	JL210	LU210	20	1-9/16	8-1/4	1-1/2	15/16	--	14	10d	8	10d x 1-1/2	1650	1885	2030	1030			
													1960	2040	2040				
	JL210IF-TZ	LUC210Z	18	1-9/16	8-1/4	1-1/2	--	--	11	10d HDG	6	10d x 1-1/2 HDG	1320	1505	1625	1115			
													1575	1785	1940				
	JUS210	LUS210	18	1-9/16	7-3/4	1-3/4	1	--	8	10d	4	10d	1350	1545	1670	1050			
	SUH210	U210	16	1-9/16	8	2	1-3/16	--	10	10d	6	10d x 1-1/2	1250	1405	1515	1135			
													1470	1670	1800				
	HUS210	HUS210	16	1-5/8	9-3/16	3	2	--	30	16d	10	16d	5455	5825	6060	4110			
HD210	HU210	14	1-9/16	7-3/16	2-1/2	1-1/8	Min	10	16d	4	10d x 1-1/2	1540	1735	1865	760				
							Max	14		6		2155	2430	2610	1170				
HD212	HU212	14	1-9/16	9-13/16	2-1/2	1-1/8	Min	14	16d	6	10d x 1-1/2	2155	2430	2610	1170				
							Max	20		10		3080	3475	3725	1510				
HD212IF	HUC212	14	1-9/16	9-1/4	2	--	--	16	16d	8	10d x 1-1/2	2465	2780	2980	1180				
2 x 14	SUH214	U214	16	1-9/16	10	2	1-1/8	--	12	10d	8	10d x 1-1/2	1500	1685	1815	1510			
													1765	2000	2160				
	HD212	HU212	14	1-9/16	9-13/16	2-1/2	1-1/8	Min	14	16d	6	10d x 1-1/2	2155	2430	2610	1170			
								Max	20		10		3080	3475	3725	1510			
HD212IF	HUC212	14	1-9/16	9-1/4	2	--	--	16	16d	8	10d x 1-1/2	2465	2780	2980	1180				
HD214	HU214	14	1-9/16	10-13/16	2-1/2	1-1/8	Min	16	16d	8	10d x 1-1/2	2465	2780	2980	1190				
							Max	24		12		3695	4125	4250	1510				
2 x 16	SUH214	U214	16	1-9/16	10	2	1-1/8	--	12	10d	8	10d x 1-1/2	1500	1685	1815	1510			
													1765	2000	2160				
	HD212	HU212	14	1-9/16	9-13/16	2-1/2	1-1/8	Min	14	16d	6	10d x 1-1/2	2155	2430	2610	1170			
								Max	20		10		3080	3475	3725	1510			
	HD212IF	HUC212	14	1-9/16	9-1/4	2	--	--	16	16d	8	10d x 1-1/2	2465	2780	2980	1180			
	HD214	HU214	14	1-9/16	10-13/16	2-1/2	1-1/8	Min	16	16d	8	10d x 1-1/2	2465	2780	2980	1190			
							Max	24		12		3695	4125	4250	1510				
HD216	HU216	14	1-9/16	12-3/4	2-1/2	1-1/8	Min	18	16d	8	10d x 1-1/2	2770	3125	3355	1510				
							Max	26		12		3930	4125	4250	1900				

IBC, FL, LA

Lumber Hangers

Copyright © 2022 MiTek Industries, Inc. All Rights Reserved

1) Uplift loads have been increased 60% for wind or seismic loads; no further increase shall be permitted.
 2) For JUS, HUS, and MUS hangers: Nails must be driven at a 30° to 45° angle through the joist or truss into the header to achieve the table loads.
 3) **NAILS:** 10d x 1-1/2 nails are 0.148" dia. x 1-1/2" long, 10d nails are 0.148" dia. x 3" long, 16d nails are 0.162" dia. x 3-1/2" long.
 New products or updated product information are designated in **blue font**.

Corrosion Finish Key ■ Stainless Steel ■ Gold Coat ■ HDG ■ Triple Zinc

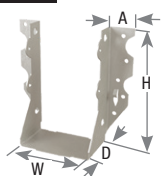

Continued on next page

Joist Size	MiTek Stock No.	Ref. No.	Steel Gauge	Dimensions (in)				Fastener Schedule ^{3,4}				DF/SP Allowable Loads (Lbs.) ²				Corrosion Finish	Code Ref.		
				W	H	D	A	Min/Max	Header		Joist		Floor		Roof			Uplift ¹	
									Qty	Type	Qty	Type	100%	115%	125%				160%
				Qty	Type	Qty	Type	100%	115%	125%	160%								
(2) 2 x 4	JUS24-2	LUS24-2	18	3-1/8	3-7/16	2	1	--	4	16d	2	16d	805	900	900	660			
	SUH24-2	U24-2	16	3-1/8	3-1/8	2	1-1/8	--	6	10d 16d	2	10d	750 880	840 1000	910 1080	380			
	HD24-2	HU24-2	14	3-1/8	3-1/2	2-1/2	1-1/8	--	4	16d	2	10d	615	695	745	365			
	HUS24-2	--	14	3-1/8	3-7/16	2	1	--	4	16d	2	16d	850	965	1040	765			
	HUS24-2IF	--	14	3-1/8	3-7/16	2	1	--	4	16d	2	16d	850	965	1040	765			
(2) 2 x 6	JUS26-2	LUS26-2	18	3-1/8	5-1/4	2	1	--	4	16d	4	16d	1040	1185	1290	1270			
	SUH26-2	U26-2	16	3-1/8	5-1/16	2	1-1/8	--	10	10d 16d	4	10d	1250 1470	1405 1670	1515 1800	755			
	HUS26-2	HUS26-2	14	3-1/8	5-1/4	2	1	--	4	16d	4	16d	1085	1235	1330	1170			
	HUS26-2IF	HUSC26-2	14	3-1/8	5-1/4	2	1	--	4	16d	4	16d	1085	1235	1330	1170			
	HD26-2	HU26-2	14	3-1/8	5-1/4	2-1/2	1-1/8	Min	8	16d	4	10d	1230	1390	1490	760			
	HD26-2IF	HUC26-2	14	3-1/8	5-1/4	2-1/2	--	Max	12	16d	6	10d	1850	2085	2235	1170			
(2) 2 x 8	JUS26-2	LUS26-2	18	3-1/8	5-1/4	2	1	--	4	16d	4	16d	1040	1185	1290	1270			
	JUS28-2	LUS28-2	18	3-1/8	7-1/8	2	1	--	6	16d	4	16d	1325	1510	1645	1270			
	SUH26-2	U26-2	16	3-1/8	5-1/16	2	1-1/8	--	10	10d 16d	4	10d	1250 1470	1405 1670	1515 1800	755			
	SUH28-2	--	16	3-1/8	6-1/4	2	1-1/8	--	12	10d 16d	4	10d	1500 1765	1685 2000	1815 2000	755			
	HUS26-2	HUS26-2	14	3-1/8	5-1/4	2	1	--	4	16d	4	16d	1085	1235	1330	1170			
	HUS26-2IF	HUSC26-2	14	3-1/8	5-1/4	2	1	--	4	16d	4	16d	1085	1235	1330	1170			
	HUS28-2	HUS28-2	14	3-1/8	7-1/8	2	1	--	6	16d	6	16d	1625	1850	1880	2420			
	HUS28-2IF	HUSC28-2	14	3-1/8	7-1/8	2	1	--	6	16d	6	16d	1625	1850	1880	2420			
	HD26-2	HU26-2	14	3-1/8	5-1/4	2-1/2	1-1/8	Min	8	16d	4	10d	1230	1390	1490	760			
	HD26-2IF	HUC26-2	14	3-1/8	5-1/4	2-1/2	--	Max	12	16d	6	10d	1850	2085	2235	1170			
	HD28-2	HU28-2	14	3-1/8	7-1/8	2-1/2	1-1/8	Min	10	16d	4	10d	1540	1735	1865	780			
	HD28-2IF	HUC28-2	14	3-1/8	7-1/8	2-1/2	--	Max	14	16d	6	10d	2155	2430	2610	1170			
(2) 2 x 10	JUS28-2	LUS28-2	18	3-1/8	7-1/8	2	1	--	6	16d	4	16d	1325	1510	1645	1270			
	JUS210-2	LUS210-2	18	3-1/8	9-1/8	2	1	--	8	16d	6	16d	1845	2105	2290	2345			
	SUH28-2	--	16	3-1/8	6-1/4	2	1-1/8	--	12	10d 16d	4	10d	1500 1765	1685 2000	1815 2000	755			
	SUH210-2	U210-2	16	3-1/8	8-9/16	2	1-1/8	--	16	10d 16d	6	10d	2000 2350	2245 2670	2420 2880	1135			
	HUS28-2	HUS28-2	14	3-1/8	7-1/8	2	1	--	6	16d	6	16d	1625	1850	1880	2420			
	HUS28-2IF	HUSC28-2	14	3-1/8	7-1/8	2	1	--	6	16d	6	16d	1625	1850	1880	2420			
	HD28-2	HU28-2	14	3-1/8	7-1/8	2-1/2	1-1/8	Min	10	16d	4	10d	1540	1735	1865	780			
	HD28-2IF	HUC28-2	14	3-1/8	7-1/8	2-1/2	--	Max	14	16d	6	10d	2155	2430	2610	1170			
	HUS210-2	HUS210-2	14	3-1/8	9-1/8	2	1	--	8	16d	8	16d	2170	2465	2660	2420			
	HUS210-2IF	HUSC210-2	14	3-1/8	9-1/8	2	1	--	8	16d	8	16d	2170	2465	2660	2420			
	HD210-2	HU210-2	14	3-1/8	9	2-1/2	1-1/8	Min	14	16d	6	10d	2155	2430	2610	1170			
	HD210-2IF	HUC210-2	14	3-1/8	9	2-1/2	--	Max	20	16d	10	10d	3080	3475	3725	1950			
	HDQ210-2IF	HUCQ210-2	14	3-1/4	9	3	1-1/2	--	12	WS3	6	WS3	5015	5145	5145	2975			

IBC, FL, LA

Copyright © 2022 MiTek Industries, Inc. All Rights Reserved

1) Uplift loads have been increased 60% for wind or seismic loads; no further increase shall be permitted.
 2) For JUS and HUS hangers: Nails must be driven at a 30° to 45° angle through the joist or truss into the header to achieve the table loads.
 3) MiTek's WS3 structural wood screws are 1/4" dia. x 3" long and are included with HDQIF hangers.
 4) **NAILS:** 10d nails are 0.148" dia. x 3" long, 16d are 0.162" dia. x 3-1/2" long.
 New products or updated product information are designated in **blue font**.

Corrosion Finish Key ■ Stainless Steel ■ Gold Coat ■ HDG ■ Triple Zinc

Continued on next page

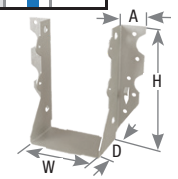

Joist Size	MiTek Stock No.	Ref. No.	Steel Gauge	Dimensions (in)				Fastener Schedule ^{3,4}				DF/SP Allowable Loads (Lbs.) ²				Corrosion Finish	Code Ref.		
				W	H	D	A	Min/Max	Header		Joist		Floor	Roof	125%			Uplift ¹	
									Qty	Type	Qty	Type							
(2) 2 x 12	JUS210-2	LUS210-2	18	3-1/8	9-1/8	2	1	--	8	16d	6	16d	1845	2105	2290	2345	Green	IBC, FL, LA	
	SUH210-2	U210-2	16	3-1/8	8-9/16	2	1-1/8	--	16	10d	6	10d	2000	2245	2420	1135	Grey		
	HUS210-2	HUS210-2	14	3-1/8	9-1/8	2	1	--	8	16d	8	16d	2170	2465	2660	2420	Green		
	HUS210-2IF	HUSC210-2	14	3-1/8	9-1/8	2	1	--	8	16d	8	16d	2170	2465	2660	2420	Green		
	HD210-2	HU210-2	14	3-1/8	9	2-1/2	1-1/8	Min	14	16d	6	10d	2155	2430	2610	1170	Green		
							Max	20	10				3080	3475	3725	1950	Green		
		HD210-2IF	HUC210-2	14	3-1/8	9	2-1/2	--	Min	14	16d	6	10d	2155	2430	2610	1170		Green
							Max	20	10	3080				3475	3725	1950	Green		
		HUS212-2	HUS212-2	14	3-1/8	11-1/8	2	1	--	10	16d	10	16d	2710	3080	3325	3615		Green
		HUS212-2IF	HUSC212-2	14	3-1/8	11-1/8	2	--	--	10	16d	10	16d	2710	3080	3325	3615		Green
	HD212-2	HU212-2	14	3-1/8	11	2-1/2	1-1/8	Min	16	16d	8	10d	2465	2780	2980	1305	Green		
						Max	24	12	3695				4170	4470	2340	Green			
	HD212-2IF	HUC212-2	14	3-1/8	11	2-1/2	--	Min	16	16d	8	10d	2465	2780	2980	1305	Green		
						Max	24	12	3695				4170	4470	2340	Green			
	HDQ210-2IF	HUCQ210-2	14	3-1/4	9	3	1-1/2	--	12	WS3	6	WS3	5015	5145	5145	2975	Blue		
(2) 2 x 14	JUS210-2	LUS210-2	18	3-1/8	9-1/8	2	1	--	8	16d	6	16d	1845	2105	2290	2345	Green	IBC, FL, LA	
	JUS214-2	LUS214-2	18	3-1/8	13-1/8	2	1	--	12	16d	6	16d	2420	2755	2830	2345	Green		
	SUH210-2	U210-2	16	3-1/8	8-9/16	2	1-1/8	--	16	10d	6	10d	2000	2245	2420	1135	Grey		
										16d			2350	2670	2880		Grey		
		HD210-2	HU210-2	14	3-1/8	9	2-1/2	1-1/8	Min	14	16d	6	10d	2155	2430	2610	1170		Green
							Max	20	10	3080				3475	3725	1950	Green		
		HD210-2IF	HUC210-2	14	3-1/8	9	2-1/2	--	Min	14	16d	6	10d	2155	2430	2610	1170		Green
							Max	20	10	3080				3475	3725	1950	Green		
		HUS210-2	HUS210-2	14	3-1/8	9-1/8	2	1	--	8	16d	8	16d	2170	2465	2660	2420		Green
		HUS210-2IF	HUSC210-2	14	3-1/8	9-1/8	2	1	--	8	16d	8	16d	2170	2465	2660	2420		Green
	HUS212-2	HUS212-2	14	3-1/8	11-1/8	2	1	--	10	16d	10	16d	2710	3080	3325	3615	Green		
	HUS212-2IF	HUSC212-2	14	3-1/8	11-1/8	2	1	--	10	16d	10	16d	2710	3080	3325	3615	Green		
	HD212-2	HU212-2	14	3-1/8	11	2-1/2	1-1/8	Min	16	16d	8	10d	2465	2780	2980	1305	Green		
						Max	24	12	3695				4170	4470	2340	Green			
	HD212-2IF	HUC212-2	14	3-1/8	11	2-1/2	--	Min	16	16d	8	10d	2465	2780	2980	1305	Green		
						Max	24	12	3695				4170	4470	2340	Green			
	HD214-2	HU214-2	14	3-1/8	13	2-1/2	1-1/8	Min	18	16d	8	10d	2770	3125	3355	1510	Green		
						Max	26	12	4005				4515	4845	2340	Green			
	HDQ210-2IF	HUCQ210-2	14	3-1/4	9	3	1-1/2	--	12	WS3	6	WS3	5015	5145	5145	2975	Blue		
(2) 2 x 16	JUS214-2	LUS214-2	18	3-1/8	13-1/8	2	1	--	12	16d	6	16d	2420	2755	2830	2345	Green	IBC, FL, LA	
	HD212-2	HU212-2	14	3-1/8	11	2-1/2	1-1/8	Min	16	16d	8	10d	2465	2780	2980	1305	Green		
							Max	24	12				3695	4170	4470	2340	Green		
	HD212-2IF	HUC212-2	14	3-1/8	11	2-1/2	--	Min	16	16d	8	10d	2465	2780	2980	1305	Green		
							Max	24	12				3695	4170	4470	2340	Green		
HD214-2	HU214-2	14	3-1/8	13	2-1/2	1-1/8	Min	18	16d	8	10d	2770	3125	3355	1510	Green			
						Max	26	12				4005	4515	4845	2340	Green			
3 x 4	SUH34	U34	16	2-9/16	3-3/8	2	1-1/8	--	6	10d	2	10d x 1-1/2	750	840	910	380	Grey	IBC, FL, LA	
										16d			880	1000	1080		Grey		
	HD34	HU34	14	2-9/16	3	2-1/2	1-1/8	Min	4	16d	2	10d x 1-1/2	615	695	745	335	Green		
						Max	4	4	585				Green						
	HD34IF	HUC34	14	2-9/16	3	2-1/2	--	Min	4	16d	2	10d x 1-1/2	615	695	745	335	Green		
						Max	4	4	585				Green						

Lumber Hangers

Copyright © 2022 MiTek Industries, Inc. All Rights Reserved

1) Uplift loads have been increased 60% for wind or seismic loads; no further increase shall be permitted.
 2) For JUS and HUS hangers: Nails must be driven at a 30° to 45° angle through the joist or truss into the header to achieve the table loads.
 3) MiTek's WS15 (1/4" dia. x 1-1/2" long) and WS3 (1/4" dia. x 3" long) structural wood screws are included with HDQIF hangers.
 4) **NAILS:** 10d x 1-1/2 nails are 0.148" dia. x 1-1/2" long, 10d nails are 0.148" dia. x 3" long, 16d nails are 0.162" dia. x 3-1/2" long.
 New products or updated product information are designated in **blue font**.

Corrosion Finish Key ■ Stainless Steel ■ Gold Coat ■ HDG ■ Triple Zinc

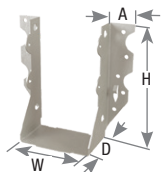

Continued on next page

Joist Size	MiTek Stock No.	Ref. No.	Steel Gauge	Dimensions (in)				Fastener Schedule ^{3,4}				DF/SP Allowable Loads (Lbs.) ²				Corrosion Finish	Code Ref.	
				W	H	D	A	Min/Max	Header		Joist		Floor	Roof	Uplift ¹			
									Qty	Type	Qty	Type						100%
3 x 6	JUS36	LUS36	18	2-9/16	5-1/4	2	1	--	4	16d	4	16d	1040	1185	1290	1270		
	SUH36	U36	16	2-9/16	5-5/16	2	1-1/8	--	10	10d	4	10d x 1-1/2	1250	1405	1515	755		
	HD36	HU36	14	2-9/16	4-3/4	2-1/2	1-1/8	--	8	16d	6	10d x 1-1/2	1230	1390	1490	760		
	HD36IF	HUC36	14	2-9/16	4-3/4	2-1/2	--	--	8	16d	6	10d x 1-1/2	1230	1390	1490	760		
3 x 8	JUS38	--	18	2-9/16	6-3/4	2	1	--	6	16d	4	16d	1325	1510	1645	1270		
	SUH36	U36	16	2-9/16	5-5/16	2	1-1/8	--	10	10d	4	10d x 1-1/2	1250	1405	1515	755		
	HD38	HU38	14	2-9/16	6-11/16	2-1/2	1-1/8	Min	10	16d	4	10d x 1-1/2	1540	1735	1865	760		
	HD38IF	HUC38	14	2-9/16	6-11/16	2-1/2	--	Max	14	16d	6	10d x 1-1/2	2155	2430	2610	1170		
3 x 10	HD38IF	HUC38	14	2-9/16	6-3/4	2	1-1/8	Min	10	16d	4	10d x 1-1/2	1540	1735	1865	760		
	HD38IF	HUC38	14	2-9/16	6-3/4	2	--	Max	14	16d	6	10d x 1-1/2	2155	2430	2610	1170		
	HD310	HU310	14	2-9/16	7-7/16	2-1/2	1-1/8	Min	10	16d	4	10d x 1-1/2	1540	1735	1865	760		
	HD310IF	HUC310	14	2-9/16	7-7/16	2-1/2	--	Max	14	16d	6	10d x 1-1/2	2155	2430	2610	1170		
	HD310IF	HUC310	14	2-9/16	7-7/16	2-1/2	--	Min	10	16d	4	10d x 1-1/2	1540	1735	1865	760		
	HD310IF	HUC310	14	2-9/16	7-7/16	2-1/2	--	Max	14	16d	6	10d x 1-1/2	2155	2430	2610	1170		
	HDQ310IF	HUCQ310	14	2-9/16	9	3	1-3/16	--	8	WS3	4	WS15	3340	3605	3605	1140		IBC, FL, LA
	HDQ310IF	HUCQ310	14	2-9/16	9	3	1-3/16	--	8	WS3	4	WS15	3340	3605	3605	1140		
3 x 12	SUH310	U310	16	2-9/16	8-7/8	2	1-1/8	--	16	10d	6	10d x 1-1/2	2000	2245	2420	1135		
	SUH310	U310	16	2-9/16	8-7/8	2	1-1/8	--	16	16d	6	10d x 1-1/2	2350	2585	2585			
	HD310	HU310	14	2-9/16	7-7/16	2-1/2	1-1/8	Min	10	16d	4	10d x 1-1/2	1540	1735	1865	760		
	HD310IF	HUC310	14	2-9/16	7-7/16	2-1/2	--	Max	14	16d	6	10d x 1-1/2	2155	2430	2610	1170		
	HD310IF	HUC310	14	2-9/16	7-7/16	2-1/2	--	Min	10	16d	4	10d x 1-1/2	1540	1735	1865	760		
	HD310IF	HUC310	14	2-9/16	7-7/16	2-1/2	--	Max	14	16d	6	10d x 1-1/2	2155	2430	2610	1170		
3 x 14	HDQ310IF	HUCQ310	14	2-9/16	9	3	1-3/16	--	8	WS3	4	WS15	3340	3605	3605	1140		
	HDQ310IF	HUCQ310	14	2-9/16	9	3	1-3/16	--	8	WS3	4	WS15	3340	3605	3605	1140		
	HD312	HU312	14	2-9/16	9-5/16	2-1/2	1-1/8	Min	14	16d	6	10d x 1-1/2	2155	2430	2610	1170		
	HD312IF	HUC312	14	2-9/16	9-5/16	2-1/2	--	Max	20	16d	10	10d x 1-1/2	3080	3475	3725	1510		
	HD312IF	HUC312	14	2-9/16	9-5/16	2-1/2	--	Min	14	16d	6	10d x 1-1/2	2155	2430	2610	1170		
	HD312IF	HUC312	14	2-9/16	9-5/16	2-1/2	--	Max	20	16d	10	10d x 1-1/2	3080	3475	3725	1510		
3 x 14	HD314	HU314	14	2-9/16	11-5/16	2-1/2	1-1/8	Min	16	16d	8	10d x 1-1/2	2465	2780	2980	1190		
	HD314IF	HUC314	14	2-9/16	11-5/16	2-1/2	--	Max	24	16d	12	10d x 1-1/2	3695	4170	4435	1900		
	HD314IF	HUC314	14	2-9/16	11-5/16	2-1/2	--	Min	16	16d	8	10d x 1-1/2	2465	2780	2980	1190		
	HD314IF	HUC314	14	2-9/16	11-5/16	2-1/2	--	Max	24	16d	12	10d x 1-1/2	3695	4170	4435	1900		
	SUH314	U314	16	2-9/16	10-9/16	2	1-1/8	--	18	10d	6	10d x 1-1/2	2250	2525	2725	1135		
	SUH314	U314	16	2-9/16	10-9/16	2	1-1/8	--	18	16d	6	10d x 1-1/2	2645	3000	3240			

1) Uplift loads have been increased 60% for wind or seismic loads; no further increase shall be permitted.
 2) For JUS and HUS hangers: Nails must be driven at a 30° to 45° angle through the joist or truss into the header to achieve the table loads.
 3) MiTek's WS15 (1/4" dia. x 1-1/2" long) and WS3 (1/4" dia. x 3" long) structural wood screws are included with HDQIF hangers.
 4) **NAILS:** 10d x 1-1/2 nails are 0.148" dia. x 1-1/2" long, 10d nails are 0.148" dia. x 3" long, 16d nails are 0.162" dia. x 3-1/2" long.
 New products or updated product information are designated in **blue font**.

Corrosion Finish Key ■ Stainless Steel ■ Gold Coat ■ HDG ■ Triple Zinc

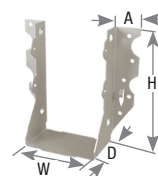

Continued on next page

Joist Size	MiTek Stock No.	Ref. No.	Steel Gauge	Dimensions (in)				Fastener Schedule ^{3,4}				DF/SP Allowable Loads (Lbs.) ²				Corrosion Finish	Code Ref.		
				W	H	D	A	Min/Max	Header		Joist		Floor		Roof			Uplift ¹	
									Qty	Type	Qty	Type	100%	115%	125%				160%
3 x 16	SUH314	U314	16	2-9/16	10-9/16	2	1-1/8	--	18	10d	6	10d x 1-1/2	2250	2525	2725	1135			
	HD314	HU314	14	2-9/16	11-5/16	2-1/2	1-1/8	Min	16	16d	8	10d x 1-1/2	2645	3000	3240				
	HD314IF	HUC314	14	2-9/16	11-5/16	2-1/2	--	Max	24	16d	12	10d x 1-1/2	2465	2780	2980	1190			
	HD316	HU316	14	2-9/16	13-5/16	2-1/2	1-1/8	Min	16	16d	8	10d x 1-1/2	2465	2780	2980	1190			
	HD316IF	HUC316	14	2-9/16	13-5/16	2-1/2	--	Max	24	16d	12	10d x 1-1/2	3695	4170	4435	1900			
(2) 3 x 8	HD38-2	HU38-2	14	5-1/8	6-1/8	2-1/2	1-1/8	Min	10	16d	4	10d	2770	3125	3355	1510			
								Max	26	16d	12	10d x 1-1/2	4005	4435	4435	1900			
(2) 3 x 10	HD38-2	HU38-2	14	5-1/8	6-1/8	2-1/2	1-1/8	Min	10	16d	4	10d	2770	3125	3355	1510			
	HD310-2	HU310-2	14	5-1/8	8	2-1/2	1-1/8	Max	26	16d	12	10d x 1-1/2	4005	4435	4435	1900			
(2) 3 x 12	HD312-2	HU312-2	14	5-1/8	10	2-1/2	1-1/8	Min	10	16d	4	10d	1540	1735	1865	780			
								Max	14	16d	6	10d	2155	2430	2610	1170			
(2) 3 x 14	HD312-2	HU312-2	14	5-1/8	10	2-1/2	1-1/8	Min	14	16d	6	10d	2155	2430	2610	1170			
								Max	20	16d	10	10d	3080	3475	3725	1510			
(3) 2 x 6	JUS26-3	LUS26-3	18	4-5/8	4-1/2	2	1	--	4	16d	4	16d	1040	1185	1290	1270			
	SUH26-3	U26-3	16	4-5/8	5-1/4	2	1	--	8	10d	2	10d	1000	1120	1210	380			
	HD26-3	HU26-3	14	4-5/8	4-1/2	2-1/2	1-1/8	Min	8	16d	4	10d	1175	1335	1440				
	HD26-3IF	HUC26-3	14	4-5/8	4-1/2	2-1/2	--	Max	12	16d	6	10d	1230	1390	1490	760			
(3) 2 x 8	HD26-3IF	HUC26-3	14	4-5/8	4-1/2	2-1/2	--	Min	8	16d	4	10d	1850	2085	2235	1170			
								Max	12	16d	6	10d	1230	1390	1490	760			
	JUS28-3	LUS28-3	18	4-5/8	6-3/8	2	1	--	4	16d	4	16d	1040	1185	1290	1270			
	SUH28-3	U28-3	16	4-5/8	5-1/4	2	1	--	8	10d	2	10d	1325	1510	1645	1270			
	HD28-3	--	14	4-5/8	6-3/8	2-1/2	1-1/8	Min	8	16d	4	10d	1000	1120	1210	380			
	HD28-3IF	--	14	4-5/8	6-3/8	2-1/2	--	Max	12	16d	6	10d	1175	1335	1440				
	HD28-3IF	--	14	4-5/8	6-3/8	2-1/2	--	Min	8	16d	4	10d	1230	1390	1490	760			
(3) 2 x 10	HD28-3IF	--	14	4-5/8	6-3/8	2-1/2	--	Max	12	16d	6	10d	1850	2085	2235	1170			
	HD28-3	--	14	4-5/8	6-3/8	2-1/2	1-1/8	Min	10	16d	4	10d	1540	1735	1865	780			
	HD28-3IF	--	14	4-5/8	6-3/8	2-1/2	--	Max	14	16d	6	10d	2155	2430	2610	1170			
	HD210-3	HU210-3	14	4-5/8	8-1/4	2-1/2	1-1/8	Min	10	16d	4	10d	1540	1735	1865	780			
	HD210-3IF	HUC210-3	14	4-5/8	8-1/4	2-1/2	--	Max	14	16d	6	10d	2155	2430	2610	1170			
	HD210-3	HU210-3	14	4-5/8	8-1/4	2-1/2	1-1/8	Min	14	16d	6	10d	2155	2430	2610	1170			
	HD210-3IF	HUC210-3	14	4-5/8	8-1/4	2-1/2	--	Max	20	16d	10	10d	3080	3475	3725	1950			
	HDQ210-3IF	HUCQ210-3	14	4-5/8	9	3	1-1/2	--	12	WS3	6	WS3	5015	5145	5145	2975			

IBC, FL, LA

Lumber Hangers

Copyright © 2022 MiTek Industries, Inc. All Rights Reserved

1) Uplift loads have been increased 60% for wind or seismic loads; no further increase shall be permitted.
 2) For JUS and HUS hangers: Nails must be driven at a 30° to 45° angle through the joist or truss into the header to achieve the table loads.
 3) MiTek's WS3 structural wood screws are 1/4" dia. x 3" long and are included with HDQIF hangers.
 4) **NAILS:** 10d x 1-1/2 nails are 0.148" dia. x 1-1/2" long, 10d nails are 0.148" dia. x 3" long, 16d nails are 0.162" dia. x 3-1/2" long.
 New products or updated product information are designated in **blue font**.

Corrosion Finish Key ■ Stainless Steel ■ Gold Coat ■ HDG ■ Triple Zinc

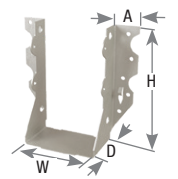

Continued on next page

Joist Size	MiTek Stock No.	Ref. No.	Steel Gauge	Dimensions (in)				Fastener Schedule ^{3,4}				DF/SP Allowable Loads (Lbs.) ²				Corrosion Finish	Code Ref.		
				W	H	D	A	Min/Max	Header		Joist		Floor		Roof			Uplift ¹	
									Qty	Type	Qty	Type	100%	115%	125%				160%
(3) 2 x 12	JUS210-3	LUS210-3	18	4-5/8	8-3/8	2	1	--	8	16d	6	16d	1845	2105	2290	2345			
	SUH210-3	U210-3	16	4-5/8	8-3/8	2	1	--	14	10d 16d	6	10d	1750 2000	1965 2000	2000	1135			
	HD210-3	HU210-3	14	4-5/8	8-1/4	2-1/2	1-1/8	Min Max	14 20	16d	6 10	10d	2155 3080	2430 3475	2610 3725	1170 1950			
	HD210-3IF	HUC210-3	14	4-5/8	8-1/4	2-1/2	--	Min Max	14 20	16d	6 10	10d	2155 3080	2430 3475	2610 3725	1170 1950			
	HDQ210-3IF	HUCQ210-3	14	4-5/8	9	3	1-1/2	--	12	WS3	6	WS3	5015	5145	5145	2975			
	HD212-3	HU212-3	14	4-5/8	10-1/4	2-1/2	1-1/8	Min Max	16 24	16d	8 12	10d	2465 3695	2780 4170	2980 4470	1305 2340			
	HD212-3IF	HUC212-3	14	4-5/8	10-1/4	2-1/2	--	Min Max	16 24	16d	8 12	10d	2465 3695	2780 4170	2980 4470	1305 2340			
(3) 2 x 14	JUS210-3	LUS210-3	18	4-5/8	8-3/8	2	1	--	8	16d	6	16d	1845	2105	2290	2345			
	SUH210-3	U210-3	16	4-5/8	8-3/8	2	1	--	14	10d 16d	6	10d	1750 2000	1965 2000	2000	1135			
	HDQ210-3IF	HUCQ210-3	14	4-5/8	9	3	1-1/2	--	12	WS3	6	WS3	5015	5145	5145	2975			
	HD212-3	HU212-3	14	4-5/8	10-1/4	2-1/2	1-1/8	Min Max	16 24	16d	8 12	10d	2465 3695	2780 4170	2980 4470	1305 2340			
	HD212-3IF	HUC212-3	14	4-5/8	10-1/4	2-1/2	--	Min Max	16 24	16d	8 12	10d	2465 3695	2780 4170	2980 4470	1305 2340			
	HD214-3	HU214-3	14	4-5/8	12-1/4	2-1/2	1-1/8	Min Max	18 26	16d	8 12	10d	2770 4005	3125 4515	3355 4845	1510 2340		IBC, FL, LA	
	HD216-3	HU216-3	14	4-5/8	13-1/4	2-1/2	1-1/8	Min Max	22 30	16d	10 14	10d	3390 4620	3820 5035	4100 5035	1950 2735			
(3) 2 x 16	HD212-3	HU212-3	14	4-5/8	10-1/4	2-1/2	1-1/8	Min Max	16 24	16d	8 12	10d	2465 3695	2780 4170	2980 4470	1305 2340			
	HD212-3IF	HUC212-3	14	4-5/8	10-1/4	2-1/2	--	Min Max	16 24	16d	8 12	10d	2465 3695	2780 4170	2980 4470	1305 2340			
	HD214-3	HU214-3	14	4-5/8	12-1/4	2-1/2	1-1/8	Min Max	18 26	16d	8 12	10d	2770 4005	3125 4515	3355 4845	1510 2340			
	HD216-3	HU216-3	14	4-5/8	13-1/4	2-1/2	1-1/8	Min Max	22 30	16d	10 14	10d	3390 4620	3820 5035	4100 5035	1950 2735			
(4) 2 x 8	HD28-4	HU28-4	14	6-1/8	7	2-1/2	1-3/4	Min Max	10 14	16d	4 6	16d	1540 2155	1735 2430	1865 2610	870 1305			
	HD210-4	HU210-4	14	6-1/8	9-1/4	2-1/2	2	Min Max	14 18	16d	6 8	16d	2155 2770	2430 3125	2610 3355	1305 1845			
(4) 2 x 10	HD210-4	HU210-4	14	6-1/8	9-1/4	2-1/2	2	Min Max	14 18	16d	6 8	16d	2155 2770	2430 3125	2610 3355	1305 1845			
	HD210-4	HU210-4	14	6-1/8	9-1/4	2-1/2	2	Min Max	14 18	16d	6 8	16d	2155 2770	2430 3125	2610 3355	1305 1845			
(4) 2 x 12	HD210-4	HU210-4	14	6-1/8	9-1/4	2-1/2	2	Min Max	14 18	16d	6 8	16d	2155 2770	2430 3125	2610 3355	1305 1845			
	HD210-4	HU210-4	14	6-1/8	9-1/4	2-1/2	2	Min Max	14 18	16d	6 8	16d	2155 2770	2430 3125	2610 3355	1305 1845			
4 x 4	JUS44	LUS44	18	3-5/8	3-1/4	2	1	--	4	16d	2	16d	780	780	780	660			
	SUH44	U44	16	3-9/16	2-7/8	2	1-1/8	--	6	10d 16d	2	10d	750 880	840 1000	910 1080	380			
	HD44	HU44	14	3-9/16	3-5/16	2-1/2	1-1/8	--	4	16d	2	10d	615	695	745	390			
	HD44IF	HUC44	14	3-9/16	3-5/16	2-1/2	--	--	4	16d	2	10d	615	695	745	390			

1) Uplift loads have been increased 60% for wind or seismic loads; no further increase shall be permitted.
 2) For JUS and HUS hangers: Nails must be driven at a 30° to 45° angle through the joist or truss into the header to achieve the table loads.
 3) MiTek's WS3 structural wood screws are 1/4" dia. x 3" long and are included with HDQIF hangers.
 4) **NAILS:** 10d nails are 0.148" dia. x 3" long, 16d nails are 0.162" dia. x 3-1/2" long.
 New products or updated product information are designated in **blue font**.

Corrosion Finish Key ■ Stainless Steel ■ Gold Coat ■ HDG ■ Triple Zinc

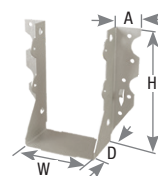

Continued on next page

Joist Size	MiTek Stock No.	Ref. No.	Steel Gauge	Dimensions (in)				Fastener Schedule ^{3,4}				DF/SP Allowable Loads (Lbs.) ²				Corrosion Finish	Code Ref.	
				W	H	D	A	Min/Max	Header		Joist		Allowable Loads (Lbs.) ²					
									Qty	Type	Qty	Type	Floor	Roof	Uplift ¹			
				100%	115%	125%	160%											
4 x 6	JUS46	LUS46	18	3-5/8	5	2	1	--	4	16d	4	16d	1040	1185	1290	1270		
	SUH46	U46	16	3-9/16	4-13/16	2	1-1/8	--	10	10d 16d	4	10d	1250 1470	1405 1670	1515 1800	755		
	HUS46	HUS46	14	3-5/8	5	2	1	--	4	16d	4	16d	1085	1235	1330	1170		
	HUS46IF	HUSC46	14	3-5/8	5	2	1	--	4	16d	4	16d	1085	1235	1330	1170		
	HD46	HU46	14	3-9/16	5-1/16	2-1/2	1-1/8	Min Max	8 12	16d	4 6	10d	1230 1850	1390 2085	1490 2235	760 1170		
	HD46IF	HUC46	14	3-9/16	5-1/16	2-1/2	--	Min Max	8 12	16d	4 6	10d	1230 1850	1390 2085	1490 2235	760 1170		
4 x 8	JUS46	LUS46	18	3-5/8	5	2	1	--	4	16d	4	16d	1040	1185	1290	1270		
	JUS48	LUS48	18	3-5/8	6-7/8	2	1	--	6	16d	4	16d	1325	1510	1645	1270		
	SUH46	U46	16	3-9/16	4-13/16	2	1-1/8	--	10	10d 16d	4	10d	1250 1470	1405 1670	1515 1800	755		
	HUS46	HUS46	14	3-5/8	5	2	1	--	4	16d	4	16d	1085	1235	1330	1170		
	HUS46IF	HUSC46	14	3-5/8	5	2	1	--	4	16d	4	16d	1085	1235	1330	1170		
	HUS48	HUS48	14	3-5/8	7	2	1	--	6	16d	6	16d	1625	1850	1880	2420		
	HUS48IF	HUSC48	14	3-5/8	7	2	1	--	6	16d	6	16d	1625	1850	1880	2420		
	HD46	HU46	14	3-9/16	5-1/16	2-1/2	1-1/8	Min Max	8 12	16d	4 6	10d	1230 1850	1390 2085	1490 2235	760 1170		
	HD46IF	HUC46	14	3-9/16	5-1/16	2-1/2	--	Min Max	8 12	16d	4 6	10d	1230 1850	1390 2085	1490 2235	760 1170		
	HD48	HU48	14	3-9/16	6-15/16	2-1/2	1-1/8	Min Max	10 14	16d	4 6	10d	1540 2155	1735 2430	1865 2610	780 1170		IBC, FL, LA
HD48IF	HUC48	14	3-9/16	6-15/16	2-1/2	--	Min Max	10 14	16d	4 6	10d	1540 2155	1735 2430	1865 2610	780 1170			
4 x 10	JUS48	LUS48	18	3-5/8	6-7/8	2	1	--	6	16d	4	16d	1325	1510	1645	1270		
	JUS410	LUS410	18	3-5/8	8-7/8	2	1	--	8	16d	6	16d	1845	2105	2290	2345		
	SUH410	U410	16	3-9/16	8-3/8	2	1-1/8	--	16	10d 16d	6	10d	2000 2350	2245 2670	2420 2880	1135		
	HUS48	HUS48	14	3-5/8	7	2	1	--	6	16d	6	16d	1625	1850	1880	2420		
	HUS48IF	HUSC48	14	3-5/8	7	2	1	--	6	16d	6	16d	1625	1850	1880	2420		
	HD48	HU48	14	3-9/16	6-15/16	2-1/2	1-1/8	Min Max	10 14	16d	4 6	10d	1540 2155	1735 2430	1865 2610	780 1170		
	HD48IF	HUC48	14	3-9/16	6-15/16	2-1/2	--	Min Max	10 14	16d	4 6	10d	1540 2155	1735 2430	1865 2610	780 1170		
	HUS410	HUS410	14	3-5/8	8-7/8	2	1	--	8	16d	8	16d	2170	2465	2660	2420		
	HUS410IF	HUSC410	14	3-5/8	8-7/8	2	1	--	8	16d	8	16d	2170	2465	2660	2420		
	HD410	HU410	14	3-9/16	8-13/16	2-1/2	1-1/8	Min Max	14 20	16d	6 10	10d	2155 3080	2430 3475	2610 3725	1170 1950		
	HD410IF	HUC410	14	3-9/16	8-13/16	2-1/2	--	Min Max	14 20	16d	6 10	10d	2155 3080	2430 3475	2610 3725	1170 1950		
	HDQ410IF	HUCQ410	14	3-9/16	9	3	1-1/2	--	12	WS3	6	WS3	5015	5145	5145	2975		

1) Uplift loads have been increased 60% for wind or seismic loads; no further increase shall be permitted.
 2) For JUS and HUS hangers: Nails must be driven at a 30° to 45° angle through the joist or truss into the header to achieve the table loads.
 3) MiTek's WS3 structural wood screws are 1/4" dia. x 3" long and are included with HDQIF hangers.
 4) **NAILS:** 10d nails are 0.148" dia. x 3" long, 16d nails are 0.162" dia. x 3-1/2" long.
 New products or updated product information are designated in **blue font**.

Corrosion Finish Key ■ Stainless Steel ■ Gold Coat ■ HDG ■ Triple Zinc

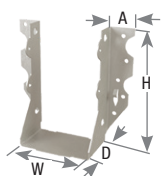

Continued on next page

Joist Size	MiTek Stock No.	Ref. No.	Steel Gauge	Dimensions (in)				Fastener Schedule ^{3,4}				DF/SP Allowable Loads (Lbs.) ²				Corrosion Finish	Code Ref.		
				W	H	D	A	Min/Max	Header		Joist		Floor		Roof			Uplift ¹	
									Qty	Type	Qty	Type	100%	115%	125%				160%
4 x 12	JUS410	LUS410	18	3-5/8	8-7/8	2	1	--	8	16d	6	16d	1845	2105	2290	2345			
	SUH410	U410	16	3-9/16	8-3/8	2	1-1/8	--	16	10d	6	10d	2000	2245	2420	1135			
	HUS410	HUS410	14	3-5/8	8-7/8	2	1	--	8	16d	8	16d	2170	2465	2660	2420			
	HUS410IF	HUSC410	14	3-5/8	8-7/8	2	1	--	8	16d	8	16d	2170	2465	2660	2420			
	HD410	HU410	14	3-9/16	8-13/16	2-1/2	1-1/8	Min	14	16d	6	10d	2155	2430	2610	1170			
								Max	20		10		3080	3475	3725	1950			
	HD410IF	HUC410	14	3-9/16	8-13/16	2-1/2	--	Min	14	16d	6	10d	2155	2430	2610	1170			
								Max	20		10		3080	3475	3725	1950			
	HDQ410IF	HUCQ410	14	3-9/16	9	3	1-1/2	--	12	WS3	6	WS3	5015	5145	5145	2975			
	HUS412	HUS412	14	3-5/8	10-7/8	2	1	--	10	16d	10	16d	2710	3080	3325	3615			
	HUS412IF	HUSC412	14	3-5/8	10-7/8	2	1	--	10	16d	10	16d	2710	3080	3325	3615			
HD412	HU412	14	3-9/16	10-13/16	2-1/2	1-1/8	Min	16	16d	8	10d	2465	2780	2980	1305				
							Max	24		12		3695	4170	4470	2340				
HD412IF	HUC412	14	3-9/16	10-13/16	2-1/2	--	Min	16	16d	8	10d	2465	2780	2980	1305				
							Max	24		12		3695	4170	4470	2340				
HDQ412IF	HUCQ412	14	3-9/16	11	3	1-1/2	--	14	WS3	6	WS3	5605	5605	5605	3280				
4 x 14	JUS414	LUS414	18	3-5/8	12-7/8	2	1	--	12	16d	6	16d	2405	2405	2405	2345			
	SUH414	U414	16	3-9/16	10-1/16	2	1-1/8	--	18	10d	6	10d	2250	2525	2725	1135			
										16d			2645	3000	3240				
	HD410	HU410	14	3-9/16	8-13/16	2-1/2	1-1/8	Min	14	16d	6	10d	2155	2430	2610	1170			
								Max	20		10		3080	3475	3725	1950			
	HD410IF	HUC410	14	3-9/16	8-13/16	2-1/2	--	Min	14	16d	6	10d	2155	2430	2610	1170			
								Max	20		10		3080	3475	3725	1950			
	HDQ410IF	HUCQ410	14	3-9/16	9	3	1-1/2	--	12	WS3	6	WS3	5015	5145	5145	2975			
	HUS412	HUS412	14	3-5/8	10-7/8	2	1	--	10	16d	10	16d	2710	3080	3325	3615			
	HUS412IF	HUSC412	14	3-5/8	10-7/8	2	1	--	10	16d	10	16d	2710	3080	3325	3615			
	HDQ412IF	HUCQ412	14	3-9/16	11	3	1-1/2	--	14	WS3	6	WS3	5605	5605	5605	3280			
HD412	HU412	14	3-9/16	10-13/16	2-1/2	1-1/8	Min	16	16d	8	10d	2465	2780	2980	1305				
							Max	24		12		3695	4170	4470	2340				
HD412IF	HUC412	14	3-9/16	10-13/16	2-1/2	--	Min	16	16d	8	10d	2465	2780	2980	1305				
							Max	24		12		3695	4170	4470	2340				
HD414	HU414	14	3-9/16	12-13/16	2-1/2	1-1/8	Min	18	16d	8	10d	2770	3125	3355	1510				
							Max	26		12		4005	4515	4815	2340				
HD414IF	HUC414	14	3-9/16	12-13/16	2-1/2	--	Min	18	16d	8	10d	2770	3125	3355	1510				
							Max	26		12		4005	4515	4815	2340				
4 x 16	JUS414	LUS414	18	3-5/8	12-7/8	2	1	--	12	16d	6	16d	2405	2405	2405	2345			
	SUH414	U414	16	3-9/16	10-1/16	2	1-1/8	--	18	10d	6	10d	2250	2525	2725	1135			
										16d			2645	3000	3240				
	HD412	HU412	14	3-9/16	10-13/16	2-1/2	1-1/8	Min	16	16d	8	10d	2465	2780	2980	1305			
								Max	24		12		3695	4170	4470	2340			
	HD412IF	HUC412	14	3-9/16	10-13/16	2-1/2	--	Min	16	16d	8	10d	2465	2780	2980	1305			
								Max	24		12		3695	4170	4470	2340			
	HDQ412IF	HUCQ412	14	3-9/16	11	3	1-1/2	--	14	WS3	6	WS3	5605	5605	5605	3280			
	HD414	HU414	14	3-9/16	12-13/16	2-1/2	1-1/8	Min	18	16d	8	10d	2770	3125	3355	1510			
							Max	26		12		4005	4515	4815	2340				
HD414IF	HUC414	14	3-9/16	12-13/16	2-1/2	--	Min	18	16d	8	10d	2770	3125	3355	1510				
							Max	26		12		4005	4515	4815	2340				
HD416	HU416	14	3-9/16	14-13/16	2-1/2	1-1/8	Min	22	16d	10	10d	3390	3820	4100	1950				
							Max	30		14		4620	4990	4990	2245				
HD416IF	HUC416	14	3-9/16	14-13/16	2-1/2	--	Min	22	16d	10	10d	3390	3820	4100	1950				
							Max	30		14		4620	4990	4990	2245				

IBC, FL, LA

Lumber Hangers

Copyright © 2022 MiTek Industries, Inc. All Rights Reserved

- 1) Uplift loads have been increased 60% for wind or seismic loads; no further increase shall be permitted.
 - 2) For JUS and HUS hangers: Nails must be driven at a 30° to 45° angle through the joist or truss into the header to achieve the table loads.
 - 3) MiTek's WS3 structural wood screws are 1/4" dia. x 3" long and are included with HDQIF hangers.
 - 4) **NAILS:** 10d nails are 0.148" dia. x 3" long, 16d nails are 0.162" dia. x 3-1/2" long.
- New products or updated product information are designated in **blue font**.

Corrosion Finish Key ■ Stainless Steel ■ Gold Coat ■ HDG ■ Triple Zinc

Continued on next page

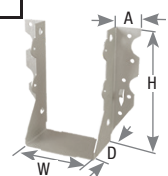

Joist Size	MiTek Stock No.	Ref. No.	Steel Gauge	Dimensions (in)				Fastener Schedule ³				DF/SP Allowable Loads (Lbs.) ²				Corrosion Finish	Code Ref.		
				W	H	D	A	Min/Max	Header		Joist		Floor		Roof			Uplift ¹	
									Qty	Type	Qty	Type	100%	115%	125%				160%
4 x 18	HD414	HU414	14	3-9/16	12-13/16	2-1/2	1-1/8	Min 18 Max 26	18	16d	8	10d	2770 4005	3125 4515	3355 4815	1510 2340			
	HD414IF	HUC414	14	3-9/16	12-13/16	2-1/2	--	Min 18 Max 26	18	16d	8	10d	2770 4005	3125 4515	3355 4815	1510 2340			
	HD416	HU416	14	3-9/16	14-13/16	2-1/2	1-1/8	Min 22 Max 30	22	16d	10	10d	3390 4620	3820 4990	4100 4990	1950 2245			
	HD416IF	HUC416	14	3-9/16	14-13/16	2-1/2	--	Min 22 Max 30	22	16d	10	10d	3390 4620	3820 4990	4100 4990	1950 2245			
	HD418	--	14	3-9/16	16-1/2	2-1/2	1-1/4	--	28	16d	8	10d	4310	4815	4815	1560			
6 x 6	SUH66	U66	16	5-1/2	5	2	1	--	8	10d 16d	4	10d	1000 1175	1120 1335	1210 1440	755			
	HD66	HU66	14	5-1/2	4-1/16	2-1/2	1-1/8	Min 8 Max 12	8	16d	4	16d	1230 1850	1390 2085	1490 2235	870 1305			
	HD66IF	HUC66	14	5-1/2	4-1/16	2-1/2	--	Min 8 Max 12	8	16d	4	16d	1230 1850	1390 2085	1490 2235	870 1305			
6 x 8	SUH66	U66	16	5-1/2	5	2	1	--	8	10d 16d	4	10d	1000 1175	1120 1335	1210 1440	755			
	HD66	HU66	14	5-1/2	4-1/16	2-1/2	1-1/8	Min 8 Max 12	8	16d	4	16d	1230 1850	1390 2085	1490 2235	870 1305			
	HD66IF	HUC66	14	5-1/2	4-1/16	2-1/2	--	Min 8 Max 12	8	16d	4	16d	1230 1850	1390 2085	1490 2235	870 1305			
	HD68	HU68	14	5-1/2	5-15/16	2-1/2	1-1/8	Min 10 Max 14	10	16d	4	16d	1540 2155	1735 2430	1865 2610	920 1305		IBC, FL, LA	
	HD68IF	HUC68	14	5-1/2	5-15/16	2-1/2	--	Min 10 Max 14	10	16d	4	16d	1540 2155	1735 2430	1865 2610	920 1305			
6 x 10	SUH610	U610	16	5-1/2	9	2	1	--	14	10d 16d	6	10d	1750 2060	1965 2335	2120 2520	1135			
	HD68	HU68	14	5-1/2	5-15/16	2-1/2	1-1/8	Min 10 Max 14	10	16d	4	16d	1540 2155	1735 2430	1865 2610	920 1305			
	HD68IF	HUC68	14	5-1/2	5-15/16	2-1/2	--	Min 10 Max 14	10	16d	4	16d	1540 2155	1735 2430	1865 2610	920 1305			
	HD610	HU610	14	5-1/2	7-13/16	2-1/2	1-1/8	Min 14 Max 20	14	16d	6	16d	2155 3080	2430 3475	2610 3725	1305 2305			
	HD610IF	HUC610	14	5-1/2	7-13/16	2-1/2	--	Min 14 Max 20	14	16d	6	16d	2155 3080	2430 3475	2610 3725	1305 2305			
	HDQ610IF	HUCQ610	14	5-1/2	9	3	1-1/8	--	12	WS3	6	WS3	5015	5145	5145	2975			
6 x 12	SUH610	U610	16	5-1/2	9	2	1	--	14	10d 16d	6	10d	1750 2060	1965 2335	2120 2520	1135			
	HD610	HU610	14	5-1/2	7-13/16	2-1/2	1-1/8	Min 14 Max 20	14	16d	6	16d	2155 3080	2430 3475	2610 3725	1305 2305			
	HD610IF	HUC610	14	5-1/2	7-13/16	2-1/2	--	Min 14 Max 20	14	16d	6	16d	2155 3080	2430 3475	2610 3725	1305 2305			
	HDQ610IF	HUCQ610	14	5-1/2	9	3	1-1/2	--	12	WS3	6	WS3	5015	5145	5145	2975			
	HD612	HU612	14	5-1/2	9-13/16	2-1/2	1-1/8	Min 16 Max 24	16	16d	8	16d	2465 3695	2780 4170	2980 4470	1305 2765			
	HD612IF	HUC612	14	5-1/2	9-13/16	2-1/2	--	Min 16 Max 24	16	16d	8	16d	2465 3695	2780 4170	2980 4470	1305 2765			
HDQ612IF	HUCQ612	14	5-1/2	11	3	1-1/2	--	14	WS3	6	WS3	5605	5605	5605	3280				

1) Uplift loads have been increased 60% for wind or seismic loads; no further increase shall be permitted.

2) MiTek's WS3 structural wood screws are 1/4" dia. x 3" long and are included with HDQIF hangers.

3) **NAILS:** 10d nails are 0.148" dia. x 3" long, 16d nails are 0.162" dia. x 3-1/2" long.

New products or updated product information are designated in **blue font**.

Corrosion Finish Key ■ Stainless Steel ■ Gold Coat ■ HDG ■ Triple Zinc

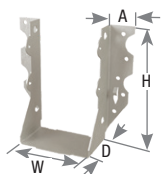

Continued on next page

Joist Size	MiTek Stock No.	Ref. No.	Steel Gauge	Dimensions (in)				Fastener Schedule ^{2,3}				DF/SP Allowable Loads (Lbs.)				Corrosion Finish	Code Ref.	
				W	H	D	A	Min/Max	Header		Joist		Allowable Loads (Lbs.)					
									Qty	Type	Qty	Type	Floor	Roof				Uplift ¹
6 x 14	HDQ610IF	HUCQ610	14	5-1/2	9	3	1-1/2	--	12	WS3	6	WS3	5015	5145	5145	2975		
	HD612	HU612	14	5-1/2	9-13/16	2-1/2	1-1/8	Min	16	16d	8	16d	2465	2780	2980	1305		
								Max	24		12		3695	4170	4470	2765		
	HD612IF	HUC612	14	5-1/2	9-13/16	2-1/2	--	Min	16	16d	8	16d	2465	2780	2980	1305		
								Max	24		12		3695	4170	4470	2765		
	HDQ612IF	HUCQ612	14	5-1/2	11	3	1-1/2	--	14	WS3	6	WS3	5605	5605	5605	3280		
HD614	HU614	14	5-1/2	11-13/16	2-1/2	1-1/8	Min	18	16d	8	16d	2770	3125	3355	1845			
							Max	26		12		4005	4515	4845	2765			
HD614IF	HUC614	14	5-1/2	11-13/16	2-1/2	--	Min	18	16d	8	16d	2770	3125	3355	1845			
							Max	26		12		4005	4515	4845	2765			
6 x 16	HD612	HU612	14	5-1/2	9-13/16	2-1/2	1-1/8	Min	16	16d	8	16d	2465	2780	2980	1305		
								Max	24		12		3695	4170	4470	2765		
	HD612IF	HUC612	14	5-1/2	9-13/16	2-1/2	--	Min	16	16d	8	16d	2465	2780	2980	1305		
								Max	24		12		3695	4170	4470	2765		
	HDQ612IF	HUCQ612	14	5-1/2	11	3	1-1/2	--	14	WS3	6	WS3	5605	5605	5605	3280		
	HD614	HU614	14	5-1/2	11-13/16	2-1/2	1-1/8	Min	18	16d	8	16d	2770	3125	3355	1845		
Max								26	12		4005		4515	4845	2765			
HD614IF	HUC614	14	5-1/2	11-13/16	2-1/2	--	Min	18	16d	8	16d	2770	3125	3355	1845			
							Max	26		12		4005	4515	4845	2765			
HD616	HU616	14	5-1/2	13-13/16	2-1/2	1-1/8	Min	22	16d	10	16d	3390	3820	4100	2305			
							Max	30		14		4620	4990	4990	3225			
HD616IF	HUC616	14	5-1/2	13-13/16	2-1/2	--	Min	22	16d	10	16d	3390	3820	4100	2305			
							Max	30		14		4620	4990	4990	3225			
6 x 18	HD614	HU614	14	5-1/2	11-13/16	2-1/2	1-1/8	Min	18	16d	8	16d	2770	3125	3355	1845		
								Max	26		12		4005	4515	4845	2765		
	HD614IF	HUC614	14	5-1/2	11-13/16	2-1/2	--	Min	18	16d	8	16d	2770	3125	3355	1845		
								Max	26		12		4005	4515	4845	2765		
HD616	HU616	14	5-1/2	13-13/16	2-1/2	1-1/8	Min	22	16d	10	16d	3390	3820	4100	2305			
							Max	30		14		4620	4990	4990	3225			
HD616IF	HUC616	14	5-1/2	13-13/16	2-1/2	--	Min	22	16d	10	16d	3390	3820	4100	2305			
							Max	30		14		4620	4990	4990	3225			
8 x 6	HD86	--	14	7-1/2	4-15/16	2-1/2	1-1/2	Min	8	16d	4	16d	1230	1390	1490	870		
								Max	10		4		1540	1735	1865	920		
HD86IF	--	14	7-1/2	5-1/8	2-1/2	--	--	10	16d	4	16d	1540	1735	1865	920			
8 x 8	HD88	HU88	14	7-1/2	6-13/16	2-1/2	1-1/2	Min	10	16d	4	16d	1540	1735	1865	920		
								Max	14		6		2155	2430	2610	1305		
	HD88IF	HUC88	14	7-1/2	6-13/16	2-1/2	--	Min	10	16d	4	16d	1540	1735	1865	920		
								Max	14		6		2155	2430	2610	1305		

IBC, FL, LA

Copyright © 2022 MiTek Industries, Inc. All Rights Reserved

- 1) Uplift loads have been increased 60% for wind or seismic loads; no further increase shall be permitted.
- 2) MiTek's WS3 structural wood screws are 1/4" dia. x 3" long and are included with HDQIF hangers.
- 3) **NAILS:** 10d x 1-1/2 nails are 0.148" dia. x 1-1/2" long, 10d nails are 0.148" dia. x 3" long, 16d nails are 0.162" dia. x 3-1/2" long. New products or updated product information are designated in **blue font**.

Corrosion Finish Key ■ Stainless Steel ■ Gold Coat ■ HDG ■ Triple Zinc

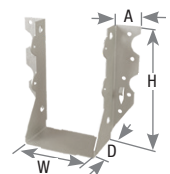

Continued on next page

Joist Size	MiTek Stock No.	Ref. No.	Steel Gauge	Dimensions (in)				Fastener Schedule ²				DF/SP Allowable Loads (Lbs.)				Code Ref.	
				W	H	D	A	Min/Max	Header		Joist		Allowable Loads (Lbs.)				
									Qty	Type	Qty	Type	Floor	Roof			Uplift ¹
100%	115%	125%	160%														
8 x 10	HD810	HU810	14	7-1/2	8-9/16	2-1/2	1-1/2	Min	14	16d	6	16d	2155	2430	2610	1305	IBC, FL, LA
								Max	18		8		2770	3125	3355	1845	
	HD810IF	HUC810	14	7-1/2	8-9/16	2-1/2	--	Min	14	16d	6	16d	2155	2430	2610	1305	
								Max	18		8		2770	3125	3355	1845	
8 x 12	HD812	HU812	14	7-1/2	10-1/2	2-1/2	1-1/2	Min	16	16d	6	16d	2465	2780	2980	1305	
								Max	22		8		3390	3820	4100	1845	
	HD812IF	HUC812	14	7-1/2	10-1/2	2-1/2	--	Min	16	16d	6	16d	2465	2780	2980	1305	
								Max	22		8		3390	3820	4100	1845	
8 x 14	HD814	HU814	14	7-1/2	11-13/16	2-1/2	1-1/2	Min	18	16d	8	16d	2770	3125	3355	1845	
								Max	24		12		3695	4170	4435	2765	
	HD814IF	HUC814	14	7-1/2	11-13/16	2-1/2	--	Min	18	16d	8	16d	2770	3125	3355	1845	
								Max	24		12		3695	4170	4435	2765	
8 x 16	HD816	HU816	14	7-1/2	12-13/16	2-1/2	1-1/2	Min	20	16d	8	16d	3080	3475	3725	1845	
								Max	26		12		4005	4435	4435	2765	
	HD816IF	HUC816	14	7-1/2	13-5/8	2-1/2	--	Min	26	16d	12	16d	4005	4435	4435	2765	
								Max	26		12		4005	4435	4435	2765	
ROUGH LUMBER SIZES																	
2 x 4	SUH24R	LU24R-18, U24R	16	2	3-1/16	2	1-1/8	--	4	10d	2	10d x 1-1/2	500	560	605	380	
										16d			590	665	720		
2 x 6 - 8	SUH26R	LU26R-18, U26R	16	2	4-15/16	2	1-3/16	--	6	10d	4	10d x 1-1/2	750	840	910	755	
										16d			880	1000	1080		
2 x 8 - 10	SUH28R	LU28R-18	16	2	6-7/16	2	1-1/8	--	8	10d	6	10d x 1-1/2	1000	1120	1210	875	
										16d			1175	1335	1440		
2 x 10 - 12	SUH210R	LU210R-18, U210R	16	2	7-13/16	2	1-1/8	--	10	10d	6	10d x 1-1/2	1250	1405	1515	1135	
										16d			1470	1670	1800		
2 x 14 - 16	SUH214R	--	16	2	9-13/16	2	1-1/8	--	12	10d	8	10d x 1-1/2	1500	1685	1815	1510	
										16d			1765	2000	2160		
4 x 4	SUH44R	U44R	16	4	2-11/16	2	1-1/8	--	6	10d	2	16d	750	840	910	450	
										16d			880	1000	1080		
4 x 6	SUH46R	U46R	16	4	4-11/16	2	1-1/8	--	8	10d	4	16d	1000	1120	1210	875	
										16d			1175	1335	1440		
4 x 10 - 12	SUH410R	U410R	16	4	8-3/16	2	2	--	14	10d	6	16d	1750	1965	2120	1220	
										16d			2060	2335	2520		
6 x 8	SUH66R	U66R	16	6	5	2	1	--	8	10d	4	16d	1000	1120	1210	875	
										16d			1175	1335	1440		
6 x 10 - 12 - 14	SUH610R	U610R	16	6	9	2	1	--	14	10d	6	16d	1750	1965	2120	1220	
										16d			2060	2335	2520		
GLULAM SIZES																	
3-1/8 x 10-1/2 - 19-1/2	HD32105	HU3.25/10.5	14	3-1/4	9-15/16	2-1/2	1-1/8	Min	16	16d	6	10d	2465	2780	2980	1170	
								Max	22		10		3390	3820	4100	1950	
3-1/8 x 12 - 21	HD3212	HU3.25/12	14	3-1/4	11-7/8	2-1/2	1-1/8	Min	18	16d	8	10d	2770	3125	3355	1510	
								Max	26		12		4005	4515	4845	2340	
5-1/8 x 10-1/2 - 19-1/2	HD5112	HU5.125/12	14	5-1/4	9-15/16	2-1/2	1-1/8	Min	16	16d	8	16d	2465	2780	2980	1305	
								Max	24		12		3695	4170	4470	2765	
5-1/8 x 14-1/2 - 21	HD51135	HU5.125/13.5	14	5-1/4	12-15/16	2-1/2	1-1/8	Min	20	16d	10	16d	3080	3475	3725	2305	
								Max	28		14		4310	4860	5035	3225	

1) Uplift loads have been increased 60% for wind or seismic loads; no further increase shall be permitted.
 2) **NAILS:** 10d x 1-1/2 nails are 0.148" dia. x 1-1/2" long, 10d nails are 0.148" dia. x 3" long, 16d nails are 0.162" dia. x 3-1/2" long.

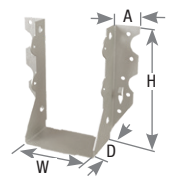

Continued on next page

Copyright © 2022 MiTek Industries, Inc. All Rights Reserved

Lumber Hangers

Joist Size	MiTek Stock No.	Ref. No.	Steel Gauge	Dimensions (in)				Fastener Schedule ³				SPF Allowable Loads (Lbs.) ²				Corrosion Finish	Code Ref.		
				W	H	D	A	Min/Max	Header		Joist		Floor		Roof			Uplift ¹	
									Qty	Type	Qty	Type	100%	115%	125%				160%
2 x 4	JL24	LU24	20	1-9/16	3	1-1/2	15/16	--	4	10d	2	10d x 1-1/2	415	475	510	235			
										16d			495	560	565				
	JL24IF-TZ	--	18	1-9/16	3-1/8	1-1/2	--	--	4	10d HDG	2	10d x 1-1/2 HDG	430	490	495	220			
										16d HDG			495	495	495				
	JUS24	LUS24	18	1-9/16	3-1/8	1-3/4	1	--	4	10d	2	10d	595	680	735	525			
2 x 6	SUH24	U24	16	1-9/16	3-1/4	2	1-3/16	--	4	10d	2	10d x 1-1/2	440	495	530	310			
										16d			515	585	635				
	HD26	HU26	14	1-9/16	3-1/2	2-1/2	1-1/8	Min	4	16d	2	10d x 1-1/2	540	610	655	265			
								Max	4		4					465			
	JL26	LU26	20	1-9/16	4-3/4	1-1/2	15/16	--	6	10d	4	10d x 1-1/2	625	710	765	485			
2 x 8										16d			740	845	915				
	JL26IF-TZ	LUC26Z	18	1-9/16	4-1/2	1-1/2	--	--	6	10d HDG	4	10d x 1-1/2 HDG	645	735	790	665			
										16d HDG			770	870	945				
	JUS26	LUS26	18	1-9/16	4-13/16	1-3/4	1	--	4	10d	4	10d	765	880	950	840			
	MUS26	MUS26	18	1-9/16	5-1/16	2	1	--	6	10d	6	10d	1235	1415	1530	785			
2 x 8	SUH26	U26	16	1-9/16	5-1/8	2	1-3/16	--	6	10d	4	10d x 1-1/2	660	740	800	665			
										16d			775	880	950				
	HUS26	HUS26	16	1-5/8	5-7/16	3	2	--	14	16d	6	16d	2430	2765	2990	1640			
	HD26	HU26	14	1-9/16	3-1/2	2-1/2	1-1/8	Min	4	16d	2	10d x 1-1/2	540	610	655	265			
								Max	4		4					465			
2 x 8	HD28	HU28	14	1-9/16	5-1/4	2-1/2	1-1/8	--	8	16d	6	10d x 1-1/2	1085	1220	1310	610			
	JL26	LU26	20	1-9/16	4-3/4	1-1/2	15/16	--	6	10d	4	10d x 1-1/2	625	710	765	485			
										16d			740	845	915				
	JL26IF-TZ	LUC26Z	18	1-9/16	4-1/2	1-1/2	--	--	6	10d HDG	4	10d x 1-1/2 HDG	645	735	790	665			
										16d HDG			770	870	945				
	JL28	LU28	20	1-9/16	6-3/8	1-1/2	15/16	--	10	10d	6	10d x 1-1/2	1040	1185	1275	665			
										16d			1230	1405	1530				
	JL28IF-TZ	--	18	1-9/16	6-1/8	1-1/2	--	--	8	10d HDG	4	10d x 1-1/2 HDG	860	980	990	665			
										16d HDG			990	990	990				
	JUS26	LUS26	18	1-9/16	4-13/16	1-3/4	1	--	4	10d	4	10d	765	880	950	840			
	JUS28	LUS28	18	1-9/16	6-5/8	1-3/4	1	--	6	10d	4	10d	980	1120	1210	840			
	MUS26	MUS26	18	1-9/16	5-1/16	2	1	--	6	10d	6	10d	1235	1415	1530	785			
	MUS28	MUS28	18	1-9/16	7-1/16	2	1	--	8	10d	8	10d	1615	1850	2000	1090			
SUH26	U26	16	1-9/16	5-1/8	2	1-3/16	--	6	10d	4	10d x 1-1/2	660	740	800	665				
									16d			775	880	950					
SUH28	--	16	1-9/16	6-5/8	2	1-3/16	--	8	10d	6	10d x 1-1/2	880	990	1065	705				
									16d			1035	1175	1265					
HUS26	HUS26	16	1-5/8	5-7/16	3	2	--	14	16d	6	16d	2430	2765	2990	1640				
HUS28	HUS28	16	1-5/8	7-3/16	3	2	--	22	16d	8	16d	3670	4035	4130	2410				
HD28	HU28	14	1-9/16	5-1/4	2-1/2	1-1/8	--	8	16d	6	10d x 1-1/2	1085	1220	1310	610				
HD210	HU210	14	1-9/16	7-3/16	2-1/2	1-1/8	Min	10	16d	4	10d x 1-1/2	1355	1525	1640	610				
							Max	14		6		1895	2140	2295	955				

IBC, FL, LA

1) Uplift loads have been increased 60% for wind or seismic loads; no further increase shall be permitted.
 2) For JUS, HUS, and MUS hangers: Nails must be driven at a 30° to 45° angle through the joist or truss into the header to achieve the table loads.
 3) **NAILS:** 10d x 1-1/2 nails are 0.148" dia. x 1-1/2" long, 10d nails are 0.148" dia. x 3" long, 16d nails are 0.162" dia. x 3-1/2" long.
 New products or updated product information are designated in **blue font**.

Corrosion Finish Key ■ Stainless Steel ■ Gold Coat ■ HDG ■ Triple Zinc

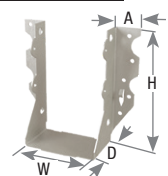

Continued on next page

Joist Size	MiTek Stock No.	Ref. No.	Steel Gauge	Dimensions (in)				Fastener Schedule ³				SPF Allowable Loads (Lbs.) ²				Corrosion Finish	Code Ref.		
				W	H	D	A	Min/Max	Header		Joist		Allowable Loads (Lbs.) ²						
									Qty	Type	Qty	Type	Floor	Roof	Uplift ¹				
100%	115%	125%	160%																
2 x 10	JL28	LU28	20	1-9/16	6-3/8	1-1/2	15/16	--	10	10d	6	10d x 1-1/2	1040	1185	1275	665			
										16d			1230	1405	1530				
	JL28IF-TZ	--	18	1-9/16	6-1/8	1-1/2	--	--	8	10d HDG	4	10d x 1-1/2 HDG	860	980	990	665			
										16d HDG			990	990	990				
	JL210	LU210	20	1-9/16	8-1/4	1-1/2	15/16	--	14	10d	8	10d x 1-1/2	1455	1655	1675	845			
										16d			1675	1675	1675				
	JL210IF-TZ	LUC210Z	18	1-9/16	8-1/4	1-1/2	--	--	11	10d HDG	6	10d x 1-1/2 HDG	1140	1305	1405	965			
										16d HDG			1360	1545	1675				
	JUS28	LUS28	18	1-9/16	6-5/8	1-3/4	1	--	6	10d	4	10d	980	1120	1210	840			
	JUS210	LUS210	18	1-9/16	7-3/4	1-3/4	1	--	8	10d	4	10d	1190	1360	1395	840			
	MUS28	MUS28	18	1-9/16	7-1/16	2	1	--	8	10d	8	10d	1745	1995	2160	1230			
	2 x 12	SUH28	--	16	1-9/16	6-5/8	2	1-3/16	--	8	10d	6	10d x 1-1/2	880	990	1065	705		
										16d			1035	1175	1265				
SUH210		U210	16	1-9/16	8	2	1-3/16	--	10	10d	6	10d x 1-1/2	1100	1235	1330	990			
										16d			1295	1465	1585				
HUS28		HUS28	16	1-5/8	7-3/16	3	2	--	22	16d	8	16d	3670	4035	4130	2410			
HUS210		HUS210	16	1-5/8	9-3/16	3	2	--	30	16d	10	16d	4235	4565	4780	3410			
HD210		HU210	14	1-9/16	7-3/16	2-1/2	1-1/8	Min	10	16d	4	10d x 1-1/2	1355	1525	1640	610			
								Max	14		6		1895	2140	2295	955			
JL210		LU210	20	1-9/16	8-1/4	1-1/2	15/16	--	14	10d	8	10d x 1-1/2	1455	1655	1675	845			
										16d			1675	1675	1675				
JL210IF-TZ		LUC210Z	18	1-9/16	8-1/4	1-1/2	--	--	11	10d HDG	6	10d x 1-1/2 HDG	1140	1305	1405	965			
										16d HDG			1360	1545	1675				
JUS210	LUS210	18	1-9/16	7-3/4	1-3/4	1	--	8	10d	4	10d	1190	1360	1395	840				
SUH210	U210	16	1-9/16	8	2	1-3/16	--	10	10d	6	10d x 1-1/2	1100	1235	1330	990				
									16d			1295	1465	1585					
HUS210	HUS210	16	1-5/8	9-3/16	3	2	--	30	16d	10	16d	4235	4565	4780	3410				
HD210	HU210	14	1-9/16	7-3/16	2-1/2	1-1/8	Min	10	16d	4	10d x 1-1/2	1355	1525	1640	610				
							Max	14		6		1895	2140	2295	955				
HD212	HU212	14	1-9/16	9-13/16	2-1/2	1-1/8	Min	14	16d	6	10d x 1-1/2	1895	2140	2295	955				
							Max	20		10		2710	2900	2990	1225				
HD212IF	HUC212	14	1-9/16	9-1/4	2	--	--	16	16d	8	10d x 1-1/2	2165	2320	2390	960				
2 x 14	SUH214	U214	16	1-9/16	10	2	1-1/8	--	12	10d	8	10d x 1-1/2	1320	1480	1595	1330			
										16d			1550	1760	1900				
	HD212	HU212	14	1-9/16	9-13/16	2-1/2	1-1/8	Min	14	16d	6	10d x 1-1/2	1895	2140	2295	955			
								Max	20		10		2710	2900	2990	1225			
	HD212IF	HUC212	14	1-9/16	9-1/4	2	--	--	16	16d	8	10d x 1-1/2	2165	2320	2390	960			
HD214	HU214	14	1-9/16	10-13/16	2-1/2	1-1/8	Min	16	16d	8	10d x 1-1/2	2165	2445	2620	960				
							Max	24		12		2985	3160	3270	1230				
2 x 16	SUH214	U214	16	1-9/16	10	2	1-1/8	--	12	10d	8	10d x 1-1/2	1320	1480	1595	1330			
										16d			1550	1760	1900				
	HD212	HU212	14	1-9/16	9-13/16	2-1/2	1-1/8	Min	14	16d	6	10d x 1-1/2	1895	2140	2295	955			
								Max	20		10		2710	2900	2990	1225			
	HD212IF	HUC212	14	1-9/16	9-1/4	2	--	--	16	16d	8	10d x 1-1/2	2165	2320	2390	960			
HD214	HU214	14	1-9/16	10-13/16	2-1/2	1-1/8	Min	16	16d	8	10d x 1-1/2	2165	2445	2620	960				
							Max	24		12		2985	3160	3270	1230				
HD216	HU216	14	1-9/16	12-3/4	2-1/2	1-1/8	Min	18	16d	8	10d x 1-1/2	2440	2640	2710	1220				
							Max	26		12		2985	3160	3270	1550				

IBC, FL, LA

Lumber Hangers

Copyright © 2022 MiTek Industries, Inc. All Rights Reserved

1) Uplift loads have been increased 60% for wind or seismic loads; no further increase shall be permitted.
 2) For JUS, HUS, and MUS hangers: Nails must be driven at a 30° to 45° angle through the joist or truss into the header to achieve the table loads.
 3) **NAILS:** 10d x 1-1/2 nails are 0.148" dia. x 1-1/2" long, 10d nails are 0.148" dia. x 3" long, 16d nails are 0.162" dia. x 3-1/2" long.
 New products or updated product information are designated in **blue font**.

Corrosion Finish Key ■ Stainless Steel ■ Gold Coat ■ HDG ■ Triple Zinc

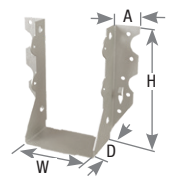

Continued on next page

Joist Size	MiTek Stock No.	Ref. No.	Steel Gauge	Dimensions (in)				Fastener Schedule ^{3,4}				SPF Allowable Loads (Lbs.) ²				Corrosion Finish	Code Ref.	
				W	H	D	A	Min/Max	Header		Joist		Allowable Loads (Lbs.) ²					
									Qty	Type	Qty	Type	Floor	Roof	Uplift ¹			100%
(2) 2 x 4	JUS24-2	LUS24-2	18	3-1/8	3-7/16	2	1	--	4	16d	2	16d	710	715	715	520		
	SUH24-2	U24-2	16	3-1/8	3-1/8	2	1-1/8	--	6	10d 16d	2	10d	660 775	740 880	800 950	330		
	HD24-2	HU24-2	14	3-1/8	3-1/2	2-1/2	1-1/8	--	4	16d	2	10d	540	610	655	290		
	HUS24-2	--	14	3-1/8	3-7/16	2	1	--	4	16d	2	16d	750	825	825	605		
	HUS24-2IF	--	14	3-1/8	3-7/16	2	1	--	4	16d	2	16d	750	825	825	605		
(2) 2 x 6	JUS26-2	LUS26-2	18	3-1/8	5-1/4	2	1	--	4	16d	4	16d	915	1045	1135	1010		
	SUH26-2	U26-2	16	3-1/8	5-1/16	2	1-1/8	--	10	10d 16d	4	10d	1100 1295	1235 1465	1330 1585	665		
	HUS26-2	HUS26-2	14	3-1/8	5-1/4	2	1	--	4	16d	4	16d	910	1035	1115	850		
	HUS26-2IF	HUSC26-2	14	3-1/8	5-1/4	2	1	--	4	16d	4	16d	955	1085	1170	930		
	HD26-2	HU26-2	14	3-1/8	5-1/4	2-1/2	1-1/8	Min	8	16d	4	10d	1085	1220	1310	605		
	HD26-2IF	HUC26-2	14	3-1/8	5-1/4	2-1/2	--	Max	12	16d	6	10d	1625	1835	1965	1030		
(2) 2 x 8	JUS26-2	LUS26-2	18	3-1/8	5-1/4	2	1	--	4	16d	4	16d	915	1045	1135	1010		
	JUS28-2	LUS28-2	18	3-1/8	7-1/8	2	1	--	6	16d	4	16d	1165	1330	1445	1010		
	SUH26-2	U26-2	16	3-1/8	5-1/16	2	1-1/8	--	10	10d 16d	4	10d	1100 1295	1235 1465	1330 1585	665		
	SUH28-2	--	16	3-1/8	6-1/4	2	1-1/8	--	12	10d 16d	4	10d	1320 1550	1480 1660	1595 1660	665		
	HUS26-2	HUS26-2	14	3-1/8	5-1/4	2	1	--	4	16d	4	16d	910	1035	1115	850		
	HUS26-2IF	HUSC26-2	14	3-1/8	5-1/4	2	1	--	4	16d	4	16d	955	1085	1170	930		
	HUS28-2	HUS28-2	14	3-1/8	7-1/8	2	1	--	6	16d	6	16d	1430	1500	1500	1935		
	HUS28-2IF	HUSC28-2	14	3-1/8	7-1/8	2	1	--	6	16d	6	16d	1430	1500	1500	1935		
	HD26-2	HU26-2	14	3-1/8	5-1/4	2-1/2	1-1/8	Min	8	16d	4	10d	1085	1220	1310	605		
	HD26-2IF	HUC26-2	14	3-1/8	5-1/4	2-1/2	--	Max	12	16d	6	10d	1625	1835	1965	1030		
	HD28-2	HU28-2	14	3-1/8	7-1/8	2-1/2	1-1/8	Min	10	16d	4	10d	1355	1525	1640	685		
	HD28-2IF	HUC28-2	14	3-1/8	7-1/8	2-1/2	--	Max	14	16d	6	10d	1895	2140	2295	1030		
(2) 2 x 10	JUS28-2	LUS28-2	18	3-1/8	7-1/8	2	1	--	6	16d	4	16d	1165	1330	1445	1010		
	JUS210-2	LUS210-2	18	3-1/8	9-1/8	2	1	--	8	16d	6	16d	1625	1850	1925	1875		
	SUH28-2	--	16	3-1/8	6-1/4	2	1-1/8	--	12	10d 16d	4	10d	1320 1550	1480 1660	1595 1660	665		
	SUH210-2	U210-2	16	3-1/8	8-9/16	2	1-1/8	--	16	10d 16d	6	10d	1760 2070	1975 2345	2130 2535	975		
	HUS28-2	HUS28-2	14	3-1/8	7-1/8	2	1	--	6	16d	6	16d	1430	1500	1500	1935		
	HUS28-2IF	HUSC28-2	14	3-1/8	7-1/8	2	1	--	6	16d	6	16d	1430	1500	1500	1935		
	HD28-2	HU28-2	14	3-1/8	7-1/8	2-1/2	1-1/8	Min	10	16d	4	10d	1355	1525	1640	685		
	HD28-2IF	HUC28-2	14	3-1/8	7-1/8	2-1/2	--	Max	14	16d	6	10d	1895	2140	2295	1030		
	HUS210-2	HUS210-2	14	3-1/8	9-1/8	2	1	--	8	16d	8	16d	1905	2170	2340	1945		
	HUS210-2IF	HUSC210-2	14	3-1/8	9-1/8	2	1	--	8	16d	8	16d	1905	2170	2340	1945		
	HD210-2	HU210-2	14	3-1/8	9	2-1/2	1-1/8	Min	14	16d	6	10d	1895	2140	2295	1030		
	HD210-2IF	HUC210-2	14	3-1/8	9	2-1/2	--	Max	20	16d	10	10d	2710	3055	3195	1715		
	HDQ210-2IF	HUCQ210-2	14	3-1/4	9	3	1-1/2	--	12	WS3	6	WS3	4480	4600	4600	2665		

IBC, FL, LA

- 1) Uplift loads have been increased 60% for wind or seismic loads; no further increase shall be permitted.
- 2) For JUS and HUS hangers: Nails must be driven at a 30° to 45° angle through the joist or truss into the header to achieve the table loads.
- 3) MiTek's WS3 structural wood screws are 1/4" dia. x 3" long and are included with HDQIF hangers.
- 4) **NAILS:** 10d nails are 0.148" dia. x 3" long, 16d are 0.162" dia. x 3-1/2" long. New products or updated product information are designated in **blue font**.

Corrosion Finish Key ■ Stainless Steel ■ Gold Coat ■ HDG ■ Triple Zinc

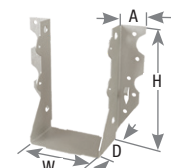

Continued on next page

Joist Size	MiTek Stock No.	Ref. No.	Steel Gauge	Dimensions (in)				Fastener Schedule ^{3,4}				SPF Allowable Loads (Lbs.) ²				Corrosion Finish	Code Ref.	
				W	H	D	A	Min/Max	Header		Joist		Allowable Loads (Lbs.) ²					
									Qty	Type	Qty	Type	Floor 100%	Roof 115%	125%			Uplift ¹ 160%
(2) 2 x 12	JUS210-2	LUS210-2	18	3-1/8	9-1/8	2	1	--	8	16d	6	16d	1625	1850	1925	1875	IBC, FL, LA	
	SUH210-2	U210-2	16	3-1/8	8-9/16	2	1-1/8	--	16	10d	6	10d	1760	1975	2130	975		
	HUS210-2	HUS210-2	14	3-1/8	9-1/8	2	1	--	8	16d	8	16d	1905	2170	2340	1945		
	HUS210-2IF	HUSC210-2	14	3-1/8	9-1/8	2	1	--	8	16d	8	16d	1905	2170	2340	1945		
	HD210-2	HU210-2	14	3-1/8	9	2-1/2	1-1/8	Min	14	16d	6	10d	1895	2140	2295	1030		
								Max	20		10		2710	3055	3195	1715		
	HD210-2IF	HUC210-2	14	3-1/8	9	2-1/2	--	Min	14	16d	6	10d	1895	2140	2295	1030		
								Max	20		10		2710	3055	3195	1715		
	HUS212-2	HUS212-2	14	3-1/8	11-1/8	2	1	--	10	16d	10	16d	2385	2710	2885	2915		
	HUS212-2IF	HUSC212-2	14	3-1/8	11-1/8	2	--	--	10	16d	10	16d	2385	2710	2885	2915		
(2) 2 x 14	HD212-2	HU212-2	14	3-1/8	11	2-1/2	1-1/8	Min	16	16d	8	10d	2165	2445	2620	1045		
							Max	24		12		3250	3665	3865	2060			
	HD212-2IF	HUC212-2	14	3-1/8	11	2-1/2	--	Min	16	16d	8	10d	2165	2445	2620	1045		
							Max	24		12		3250	3665	3865	2060			
	HDQ210-2IF	HUCQ210-2	14	3-1/4	9	3	1-1/2	--	12	WS3	6	WS3	4480	4600	4600	2665		
	JUS210-2	LUS210-2	18	3-1/8	9-1/8	2	1	--	8	16d	6	16d	1625	1850	1925	1875	IBC, FL, LA	
	JUS214-2	LUS214-2	18	3-1/8	13-1/8	2	1	--	12	16d	6	16d	2125	2260	2260	1875		
	SUH210-2	U210-2	16	3-1/8	8-9/16	2	1-1/8	--	16	10d	6	10d	1760	1975	2130	975		
										16d			2070	2345	2535			
													1895	2140	2295	1030		
(2) 2 x 16													2710	3055	3195	1715		
	HUS210-2	HUS210-2	14	3-1/8	9-1/8	2	1	--	8	16d	8	16d	1905	2170	2340	1945		
	HUS210-2IF	HUSC210-2	14	3-1/8	9-1/8	2	1	--	8	16d	8	16d	1905	2170	2340	1945		
	HUS212-2	HUS212-2	14	3-1/8	11-1/8	2	1	--	10	16d	10	16d	2385	2710	2885	2915		
	HUS212-2IF	HUSC212-2	14	3-1/8	11-1/8	2	1	--	10	16d	10	16d	2385	2710	2885	2915		
	HD212-2	HU212-2	14	3-1/8	11	2-1/2	1-1/8	Min	16	16d	8	10d	2165	2445	2620	1045		
								Max	24		12		3250	3665	3865	2060		
	HD212-2IF	HUC212-2	14	3-1/8	11	2-1/2	--	Min	16	16d	8	10d	2165	2445	2620	1045		
								Max	24		12		3250	3665	3865	2060		
	HD214-2	HU214-2	14	3-1/8	13	2-1/2	1-1/8	Min	18	16d	8	10d	2440	2750	2950	1205		
							Max	26		12		3520	3970	4045	2060			
(2) 2 x 16	HD216-2	HU216-2	14	3-1/8	14	2-1/2	1-1/8	Min	22	16d	10	10d	2980	3360	3605	1715		
							Max	30		14		4060	4060	4060	2405			
	JUS214-2	LUS214-2	18	3-1/8	13-1/8	2	1	--	12	16d	6	16d	2125	2260	2260	1875		
	HD212-2	HU212-2	14	3-1/8	11	2-1/2	1-1/8	Min	16	16d	8	10d	2165	2445	2620	1045		
								Max	24		12		3250	3665	3865	2060		
3 x 4	HD212-2IF	HUC212-2	14	3-1/8	11	2-1/2	--	Min	16	16d	8	10d	2165	2445	2620	1045		
							Max	24		12		3250	3665	3865	2060			
	HD214-2	HU214-2	14	3-1/8	13	2-1/2	1-1/8	Min	18	16d	8	10d	2440	2750	2950	1205		
							Max	26		12		3520	3970	4045	2060			
3 x 4	SUH34	U34	16	2-9/16	3-3/8	2	1-1/8	--	6	10d	2	10d x 1-1/2	660	740	800	330		
										16d			775	880	950			
	HD34	HU34	14	2-9/16	3	2-1/2	1-1/8	Min	4	16d	2	10d x 1-1/2	540	610	655	265		
							Max	4		4					465			
	HD34IF	HUC34	14	2-9/16	3	2-1/2	--	Min	4	16d	2	10d x 1-1/2	540	610	655	265		
							Max	4		4					465			

1) Uplift loads have been increased 60% for wind or seismic loads; no further increase shall be permitted.
 2) For JUS and HUS hangers: Nails must be driven at a 30° to 45° angle through the joist or truss into the header to achieve the table loads.
 3) MiTek's WS15 (1/4" dia. x 1-1/2" long) and WS3 (1/4" dia. x 3" long) structural wood screws are included with HDQIF hangers.
 4) **NAILS:** 10d x 1-1/2 nails are 0.148" dia. x 1-1/2" long, 10d nails are 0.148" dia. x 3" long, 16d nails are 0.162" dia. x 3-1/2" long.
 New products or updated product information are designated in **blue font**.

Corrosion Finish Key ■ Stainless Steel ■ Gold Coat ■ HDG ■ Triple Zinc

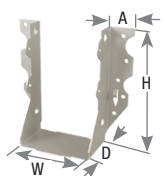

Continued on next page

Joist Size	MiTek Stock No.	Ref. No.	Steel Gauge	Dimensions (in)				Fastener Schedule ^{3,4}				SPF Allowable Loads (Lbs.) ²				Corrosion Finish	Code Ref.		
				W	H	D	A	Min/Max	Header		Joist		Floor		Roof			Uplift ¹	
									Qty	Type	Qty	Type	100%	115%	125%				160%
3 x 6	JUS36	LUS36	18	2-9/16	5-1/4	2	1	--	4	16d	4	16d	915	1045	1135	1015			
	SUH36	U36	16	2-9/16	5-5/16	2	1-1/8	--	10	10d	4	10d x 1-1/2	1100	1235	1330	665			
										16d			1295	1465	1585				
	HD36	HU36	14	2-9/16	4-3/4	2-1/2	1-1/8	--	8	16d	6	10d x 1-1/2	1085	1220	1310	610			
HD36IF	HUC36	14	2-9/16	4-3/4	2-1/2	--	--	8	16d	6	10d x 1-1/2	1085	1220	1310	610				
3 x 8	JUS38	--	18	2-9/16	6-3/4	2	1	--	6	16d	4	16d	1165	1330	1445	1015			
	SUH36	U36	16	2-9/16	5-5/16	2	1-1/8	--	10	10d	4	10d x 1-1/2	1100	1235	1330	665			
										16d			1295	1465	1585				
	HD38	HU38	14	2-9/16	6-11/16	2-1/2	1-1/8	Min	10	16d	4	10d x 1-1/2	1355	1525	1640	605			
									14				1895	2140	2295		950		
HD38IF	HUC38	14	2-9/16	6-11/16	2-1/2	--	Min	10	16d	6	10d x 1-1/2	1355	1525	1640	605				
								14				1895	2140	2295		950			
3 x 10	JUS310	LUS310	18	2-9/16	9-1/8	2	1	--	8	16d	6	16d	1625	1850	1930	1880			
	SUH310	U310	16	2-9/16	8-7/8	2	1-1/8	--	16	10d	6	10d x 1-1/2	1760	1975	2130	980			
										16d			2070	2070	2070				
	HD38	HU38	14	2-9/16	6-3/4	2	1-1/8	Min	10	16d	4	10d x 1-1/2	1355	1525	1640	605			
									14				1895	2140	2295		950		
	HD38IF	HUC38	14	2-9/16	6-3/4	2	--	Min	10	16d	4	10d x 1-1/2	1355	1525	1640	605			
									14				1895	2140	2295		950		
	HD310	HU310	14	2-9/16	7-7/16	2-1/2	1-1/8	Min	10	16d	4	10d x 1-1/2	1355	1525	1640	605			
14									1895				2140	2295	950				
HD310IF	HUC310	14	2-9/16	7-7/16	2-1/2	--	Min	10	16d	4	10d x 1-1/2	1355	1525	1640	605				
								14				1895	2140	2295		950			
HDQ310IF	HUCQ310	14	2-9/16	9	3	1-3/16	--	8	WS3	4	WS15	3215	3350	3350	1060		IBC, FL, LA		
3 x 12	SUH310	U310	16	2-9/16	8-7/8	2	1-1/8	--	16	10d	6	10d x 1-1/2	1760	1975	2130	980			
										16d			2070	2070	2070				
	HD310	HU310	14	2-9/16	7-7/16	2-1/2	1-1/8	Min	10	16d	4	10d x 1-1/2	1355	1525	1640	605			
									14				1895	2140	2295		950		
	HD310IF	HUC310	14	2-9/16	7-7/16	2-1/2	--	Min	10	16d	4	10d x 1-1/2	1355	1525	1640	605			
									14				1895	2140	2295		950		
HDQ310IF	HUCQ310	14	2-9/16	9	3	1-3/16	--	8	WS3	4	WS15	3215	3350	3350	1060				
HD312	HU312	14	2-9/16	9-5/16	2-1/2	1-1/8	Min	14	16d	6	10d x 1-1/2	1895	2140	2295	950				
								20				2710	3055	3210		1215			
HD312IF	HUC312	14	2-9/16	9-5/16	2-1/2	--	Min	14	16d	6	10d x 1-1/2	1895	2140	2295	950				
								20				2710	3055	3210		1215			
3 x 14	SUH314	U314	16	2-9/16	10-9/16	2	1-1/8	--	18	10d	6	10d x 1-1/2	1980	2220	2395	980			
										16d			2325	2640	2850				
	HDQ310IF	HUCQ310	14	2-9/16	9	3	1-3/16	--	8	WS3	4	WS15	3215	3350	3350	1060			
	HD312	HU312	14	2-9/16	9-5/16	2-1/2	1-1/8	Min	14	16d	6	10d x 1-1/2	1895	2140	2295	950			
									20				2710	3055	3210		1215		
	HD312IF	HUC312	14	2-9/16	9-5/16	2-1/2	--	Min	14	16d	6	10d x 1-1/2	1895	2140	2295	950			
20									2710				3055	3210	1215				
HD314	HU314	14	2-9/16	11-5/16	2-1/2	1-1/8	Min	16	16d	8	10d x 1-1/2	2165	2445	2620	955				
								24				3250	3665	3930		1535			
HD314IF	HUC314	14	2-9/16	11-5/16	2-1/2	--	Min	16	16d	8	10d x 1-1/2	2165	2445	2620	955				
								24				3250	3665	3930		1535			

1) Uplift loads have been increased 60% for wind or seismic loads; no further increase shall be permitted.
 2) For JUS and HUS hangers: Nails must be driven at a 30° to 45° angle through the joist or truss into the header to achieve the table loads.
 3) MiTek's WS15 (1/4" dia. x 1-1/2" long) and WS3 (1/4" dia. x 3" long) structural wood screws are included with HDQIF hangers.
 4) **NAILS:** 10d x 1-1/2" nails are 0.148" dia. x 1-1/2" long, 10d nails are 0.148" dia. x 3" long, 16d nails are 0.162" dia. x 3-1/2" long.
 New products or updated product information are designated in **blue font**.

Corrosion Finish Key ■ Stainless Steel ■ Gold Coat ■ HDG ■ Triple Zinc

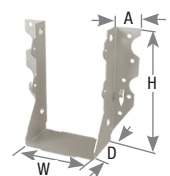

Continued on next page

Face Mount Hangers – SPF Allowable Loads

Lumber Hangers

Joist Size	MiTek Stock No.	Ref. No.	Steel Gauge	Dimensions (in)				Fastener Schedule ^{3,4}				SPF Allowable Loads (Lbs.) ²				Corrosion Finish	Code Ref.	
				W	H	D	A	Min/Max	Header		Joist		Floor	Roof	125%			Uplift ¹
									Qty	Type	Qty	Type						
				100%	115%	125%	160%											
3 x 16	SUH314	U314	16	2-9/16	10-9/16	2	1-1/8	--	18	10d 16d	6	10d x 1-1/2	1980 2325	2220 2640	2395 2850	980		
	HD314	HU314	14	2-9/16	11-5/16	2-1/2	1-1/8	Min Max	16 24	16d	8 12	10d x 1-1/2	2165 3250	2445 3665	2620 3930	955 1535		
	HD314IF	HUC314	14	2-9/16	11-5/16	2-1/2	--	Min Max	16 24	16d	8 12	10d x 1-1/2	2165 3250	2445 3665	2620 3930	955 1535		
	HD316	HU316	14	2-9/16	13-5/16	2-1/2	1-1/8	Min Max	18 26	16d	8 12	10d x 1-1/2	2440 3520	2750 3950	2950 3950	1210 1535		
	HD316IF	HUC316	14	2-9/16	13-5/16	2-1/2	--	Min Max	18 26	16d	8 12	10d x 1-1/2	2440 3520	2750 3950	2950 3950	1210 1535		
(2) 3 x 8	HD38-2	HU38-2	14	5-1/8	6-1/8	2-1/2	1-1/8	Min Max	10 14	16d	4 6	10d	1355 1895	1525 2140	1640 2295	685 1030		
(2) 3 x 10	HD38-2	HU38-2	14	5-1/8	6-1/8	2-1/2	1-1/8	Min Max	10 14	16d	4 6	10d	1355 1895	1525 2140	1640 2295	685 1030		
	HD310-2	HU310-2	14	5-1/8	8	2-1/2	1-1/8	Min Max	14 20	16d	6 10	10d	1895 2710	2140 3055	2295 3275	945 1200		
(2) 3 x 12	HD312-2	HU312-2	14	5-1/8	10	2-1/2	1-1/8	Min	16	16d	8	10d	2165	2445	2620	1035		
								Max	24		12		3250	3665	3930	2060		
(2) 3 x 14	HD312-2	HU312-2	14	5-1/8	10	2-1/2	1-1/8	Min	16	16d	8	10d	2165	2445	2620	1035		
								Max	24		12		3250	3665	3930	2060		
(3) 2 x 6	JUS26-3	LUS26-3	18	4-5/8	4-1/2	2	1	--	4	16d	4	16d	915	1045	1135	1005		
	SUH26-3	U26-3	16	4-5/8	5-1/4	2	1	--	8	10d 16d	2	10d	880 1035	990 1175	1065 1265	330		
	HD26-3	HU26-3	14	4-5/8	4-1/2	2-1/2	1-1/8	Min Max	8 12	16d	4 6	10d	1085 1625	1220 1835	1310 1965	600 1030		
	HD26-3IF	HUC26-3	14	4-5/8	4-1/2	2-1/2	--	Min Max	8 12	16d	4 6	10d	1085 1625	1220 1835	1310 1965	600 1030		
(3) 2 x 8	JUS26-3	LUS26-3	18	4-5/8	4-1/2	2	1	--	4	16d	4	16d	915	1045	1135	1005		
	JUS28-3	LUS28-3	18	4-5/8	6-3/8	2	1	--	6	16d	4	16d	1165	1330	1445	1005		
	SUH26-3	U26-3	16	4-5/8	5-1/4	2	1	--	8	10d 16d	2	10d	880 1035	990 1175	1065 1265	330		
	HD26-3	HU26-3	14	4-5/8	4-1/2	2-1/2	1-1/8	Min Max	8 12	16d	4 6	10d	1085 1625	1220 1835	1310 1965	600 1030		
	HD26-3IF	HUC26-3	14	4-5/8	4-1/2	2-1/2	--	Min Max	8 12	16d	4 6	10d	1085 1625	1220 1835	1310 1965	600 1030		
	HD28-3	--	14	4-5/8	6-3/8	2-1/2	1-1/8	Min Max	10 14	16d	4 6	10d	1355 1895	1525 2140	1640 2295	685 1030		
(3) 2 x 10	JUS28-3	LUS28-3	18	4-5/8	6-3/8	2	1	--	6	16d	4	16d	1165	1330	1445	1005		
	JUS210-3	LUS210-3	18	4-5/8	8-3/8	2	1	--	8	16d	6	16d	1625	1850	1910	1865		
	SUH210-3	U210-3	16	4-5/8	8-3/8	2	1	--	14	10d 16d	6	10d	1540 1660	1660	1660	970		
	HD28-3	--	14	4-5/8	6-3/8	2-1/2	1-1/8	Min Max	10 14	16d	4 6	10d	1355 1895	1525 2140	1640 2295	685 1030		
	HD28-3IF	--	14	4-5/8	6-3/8	2-1/2	--	Min Max	10 14	16d	4 6	10d	1355 1895	1525 2140	1640 2295	685 1030		
	HD210-3	HU210-3	14	4-5/8	8-1/4	2-1/2	1-1/8	Min Max	14 20	16d	6 10	10d	1895 2710	2140 3055	2295 3275	1030 1715		
	HD210-3IF	HUC210-3	14	4-5/8	8-1/4	2-1/2	--	Min Max	14 20	16d	6 10	10d	1895 2710	2140 3055	2295 3275	1030 1715		
	HDQ210-3IF	HUCQ210-3	14	4-5/8	9	3	1-1/2	--	12	WS3	6	WS3	4480	4575	4575	2650		

IBC, FL, LA

Lumber Hangers

Copyright © 2022 MiTek Industries, Inc. All Rights Reserved

- 1) Uplift loads have been increased 60% for wind or seismic loads; no further increase shall be permitted.
- 2) For JUS and HUS hangers: Nails must be driven at a 30° to 45° angle through the joist or truss into the header to achieve the table loads.
- 3) MiTek's WS3 structural wood screws are 1/4" dia. x 3" long and are included with HDQIF hangers.
- 4) **NAILS:** 10d x 1-1/2 nails are 0.148" dia. x 1-1/2" long, 10d nails are 0.148" dia. x 3" long, 16d nails are 0.162" dia. x 3-1/2" long. New products or updated product information are designated in blue font.

Corrosion Finish Key ■ Stainless Steel ■ Gold Coat ■ HDG ■ Triple Zinc

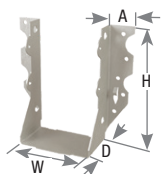

Continued on next page

Joist Size	MiTek Stock No.	Ref. No.	Steel Gauge	Dimensions (in)				Fastener Schedule ^{3,4}				SPF Allowable Loads (Lbs.) ²				Corrosion Finish	Code Ref.		
				W	H	D	A	Min/Max	Header		Joist		Floor		Roof			Uplift ¹	
									Qty	Type	Qty	Type	100%	115%	125%				160%
(3) 2 x 12	JUS210-3	LUS210-3	18	4-5/8	8-3/8	2	1	--	8	16d	6	16d	1625	1850	1910	1865			
	SUH210-3	U210-3	16	4-5/8	8-3/8	2	1	Min	14	10d	6	10d	1540	1660	1660	970			
								Max	16d				1660						
	HD210-3	HU210-3	14	4-5/8	8-1/4	2-1/2	1-1/8	Min	14	16d	6	10d	1895	2140	2295	1030			
								Max	20		10		2710	3055	3275	1715			
	HD210-3IF	HUC210-3	14	4-5/8	8-1/4	2-1/2	--	Min	14	16d	6	10d	1895	2140	2295	1030			
								Max	20		10		2710	3055	3275	1715			
	HDQ210-3IF	HUCQ210-3	14	4-5/8	9	3	1-1/2	--	12	WS3	6	WS3	4480	4575	4575	2650			
(3) 2 x 14	JUS210-3	LUS210-3	18	4-5/8	8-3/8	2	1	--	8	16d	6	16d	1625	1850	1910	1865			
	SUH210-3	U210-3	16	4-5/8	8-3/8	2	1	Min	14	10d	6	10d	1540	1660	1660	970			
								Max	16d				1660						
	HDQ210-3IF	HUCQ210-3	14	4-5/8	9	3	1-1/2	--	12	WS3	6	WS3	4480	4575	4575	2650			
	HD212-3	HU212-3	14	4-5/8	10-1/4	2-1/2	1-1/8	Min	16	16d	8	10d	2165	2445	2620	1040			
								Max	24		12		3250	3625	3625	2060			
	HD212-3IF	HUC212-3	14	4-5/8	10-1/4	2-1/2	--	Min	16	16d	8	10d	2165	2445	2620	1040			
							Max	24		12		3250	3625	3625	2060				
	HD214-3	HU214-3	14	4-5/8	12-1/4	2-1/2	1-1/8	Min	18	16d	8	10d	2440	2750	2950	1200			
							Max	26		12		3520	3970	4025	2060				
(3) 2 x 16	HD212-3	HU212-3	14	4-5/8	10-1/4	2-1/2	1-1/8	Min	16	16d	8	10d	2165	2445	2620	1040			
							Max	24		12		3250	3625	3625	2060				
	HD212-3IF	HUC212-3	14	4-5/8	10-1/4	2-1/2	--	Min	16	16d	8	10d	2165	2445	2620	1040			
							Max	24		12		3250	3625	3625	2060				
	HD214-3	HU214-3	14	4-5/8	12-1/4	2-1/2	1-1/8	Min	18	16d	8	10d	2440	2750	2950	1200			
							Max	26		12		3520	3970	4025	2060				
	HD216-3	HU216-3	14	4-5/8	13-1/4	2-1/2	1-1/8	Min	22	16d	10	10d	2980	3360	3605	1715			
							Max	30		14		4035	4035	4035	2405				
(4) 2 x 8	HD28-4	HU28-4	14	6-1/8	7	2-1/2	1-3/4	Min	10	16d	4	16d	1355	1525	1640	685			
							Max	14		6		1895	2140	2295	1035				
(4) 2 x 10	HD210-4	HU210-4	14	6-1/8	9-1/4	2-1/2	2	Min	14	16d	6	16d	1895	2140	2295	1035			
							Max	18		8		2440	2750	2950	1620				
(4) 2 x 12	HD210-4	HU210-4	14	6-1/8	9-1/4	2-1/2	2	Min	14	16d	6	16d	1895	2140	2295	1035			
							Max	18		8		2440	2750	2950	1620				
(4) 2 x 14	HD210-4	HU210-4	14	6-1/8	9-1/4	2-1/2	2	Min	14	16d	6	16d	1895	2140	2295	1035			
							Max	18		8		2440	2750	2950	1620				
4 x 4	JUS44	LUS44	18	3-5/8	3-1/4	2	1	--	4	16d	2	16d	615	615	615	520			
	SUH44	U44	16	3-9/16	2-7/8	2	1-1/8	Min	6	10d	2	10d	660	740	800	330			
								Max	16d				775	880	950				
	HD44	HU44	14	3-9/16	3-5/16	2-1/2	1-1/8	--	4	16d	2	10d	540	610	655	345			
	HD44IF	HUC44	14	3-9/16	3-5/16	2-1/2	--	--	4	16d	2	10d	540	610	655	345			

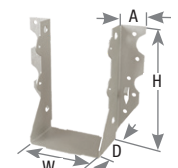

- 1) Uplift loads have been increased 60% for wind or seismic loads; no further increase shall be permitted.
- 2) For JUS and HUS hangers: Nails must be driven at a 30° to 45° angle through the joist or truss into the header to achieve the table loads.
- 3) MiTek's WS3 structural wood screws are 1/4" dia. x 3" long and are included with HDQIF hangers.
- 4) **NAILS:** 10d nails are 0.148" dia. x 3" long, 16d nails are 0.162" dia. x 3-1/2" long. New products or updated product information are designated in **blue font**.

Corrosion Finish Key ■ Stainless Steel ■ Gold Coat ■ HDG ■ Triple Zinc

Continued on next page

Joist Size	MiTek Stock No.	Ref. No.	Steel Gauge	Dimensions (in)				Fastener Schedule ^{3,4}				SPF Allowable Loads (Lbs.) ²				Corrosion Finish	Code Ref.		
				W	H	D	A	Min/Max	Header		Joist		Allowable Loads (Lbs.) ²						
									Qty	Type	Qty	Type	Floor	Roof				Uplift ¹	
				100%	115%	125%	160%	100%	115%	125%	160%								
4 x 6	JUS46	LUS46	18	3-5/8	5	2	1	--	4	16d	4	16d	915	1045	1135	1010			
	SUH46	U46	16	3-9/16	4-13/16	2	1-1/8	--	10	10d	4	10d	1100	1235	1330	665			
	HUS46	HUS46	14	3-5/8	5	2	1	--	4	16d	4	16d	955	1085	1170	930			
	HUS46IF	HUSC46	14	3-5/8	5	2	1	--	4	16d	4	16d	955	1085	1170	930			
	HD46	HU46	14	3-9/16	5-1/16	2-1/2	1-1/8	Min	8	16d	4	10d	1085	1220	1310	605			
							Max	12	6		1625		1835	1965	1030				
	HD46IF	HUC46	14	3-9/16	5-1/16	2-1/2	--	Min	8	16d	4	10d	1085	1220	1310	605			
						Max	12	6	1625		1835		1965	1030					
4 x 8	JUS46	LUS46	18	3-5/8	5	2	1	--	4	16d	4	16d	915	1045	1135	1010			
	JUS48	LUS48	18	3-5/8	6-7/8	2	1	--	6	16d	4	16d	1165	1330	1445	1010			
	SUH46	U46	16	3-9/16	4-13/16	2	1-1/8	--	10	10d	4	10d	1100	1235	1330	665			
	HUS46	HUS46	14	3-5/8	5	2	1	--	4	16d	4	16d	955	1085	1170	930			
	HUS46IF	HUSC46	14	3-5/8	5	2	1	--	4	16d	4	16d	955	1085	1170	930			
	HUS48	HUS48	14	3-5/8	7	2	1	--	6	16d	6	16d	1430	1500	1500	1930			
	HUS48IF	HUSC48	14	3-5/8	7	2	1	--	6	16d	6	16d	1430	1500	1500	1930			
	HD46	HU46	14	3-9/16	5-1/16	2-1/2	1-1/8	Min	8	16d	4	10d	1085	1220	1310	605			
							Max	12	6		1625		1835	1965	1030				
		HD46IF	HUC46	14	3-9/16	5-1/16	2-1/2	--	Min	8	16d	4	10d	1085	1220	1310	605		
						Max	12	6	1625	1835		1965		1030					
	HD48	HU48	14	3-9/16	6-15/16	2-1/2	1-1/8	Min	10	16d	4	10d	1355	1525	1640	685			
						Max	14	6	1895		2140		2295	1030					
	HD48IF	HUC48	14	3-9/16	6-15/16	2-1/2	--	Min	10	16d	4	10d	1355	1525	1640	685			
						Max	14	6	1895		2140		2295	1030					
4 x 10	JUS48	LUS48	18	3-5/8	6-7/8	2	1	--	6	16d	4	16d	1165	1330	1445	1010			
	JUS410	LUS410	18	3-5/8	8-7/8	2	1	--	8	16d	6	16d	1625	1850	1920	1870			
	SUH410	U410	16	3-9/16	8-3/8	2	1-1/8	--	16	10d	6	10d	1760	1975	2130	975			
	HUS48	HUS48	14	3-5/8	7	2	1	--	6	16d	6	16d	1430	1500	1500	1930			
	HUS48IF	HUSC48	14	3-5/8	7	2	1	--	6	16d	6	16d	1430	1500	1500	1930			
	HD48	HU48	14	3-9/16	6-15/16	2-1/2	1-1/8	Min	10	16d	4	10d	1355	1525	1640	685			
							Max	14	6		1895		2140	2295	1030				
		HD48IF	HUC48	14	3-9/16	6-15/16	2-1/2	--	Min	10	16d	4	10d	1355	1525	1640	685		
							Max	14	6	1895		2140		2295	1030				
		HUS410	HUS410	14	3-5/8	8-7/8	2	1	--	8	16d	8	16d	1905	2170	2340	1935		
		HUS410IF	HUSC410	14	3-5/8	8-7/8	2	1	--	8	16d	8	16d	1905	2170	2340	1935		
		HD410	HU410	14	3-9/16	8-13/16	2-1/2	1-1/8	Min	14	16d	6	10d	1895	2140	2295	1030		
						Max	20	10	2710	3055		3190		1715					
	HD410IF	HUC410	14	3-9/16	8-13/16	2-1/2	--	Min	14	16d	6	10d	1895	2140	2295	1030			
						Max	20	10	2710		3055		3190	1715					
	HDQ410IF	HUCQ410	14	3-9/16	9	3	1-1/2	--	12	WS3	6	WS3	4480	4590	4590	2655			

IBC, FL, LA

Lumber Hangers

Copyright © 2022 MiTek Industries, Inc. All Rights Reserved

- 1) Uplift loads have been increased 60% for wind or seismic loads; no further increase shall be permitted.
- 2) For JUS and HUS hangers: Nails must be driven at a 30° to 45° angle through the joist or truss into the header to achieve the table loads.
- 3) MiTek's WS3 structural wood screws are 1/4" dia. x 3" long and are included with HDQIF hangers.
- 4) NAILS: 10d nails are 0.148" dia. x 3" long, 16d nails are 0.162" dia. x 3-1/2" long.

New products or updated product information are designated in blue font.
Corrosion Finish Key ■ Stainless Steel ■ Gold Coat ■ HDG ■ Triple Zinc

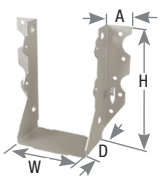

Continued on next page

Joist Size	MiTek Stock No.	Ref. No.	Steel Gauge	Dimensions (in)				Fastener Schedule ^{3,4}				SPF Allowable Loads (Lbs.) ²				Corrosion Finish	Code Ref.	
				W	H	D	A	Min/Max	Header		Joist		Allowable Loads (Lbs.) ²					
									Qty	Type	Qty	Type	Floor	Roof	Uplift ¹			
												100%	115%	125%	160%			
4 x 12	JUS410	LUS410	18	3-5/8	8-7/8	2	1	--	8	16d	6	16d	1625	1850	1920	1870		
	SUH410	U410	16	3-9/16	8-3/8	2	1-1/8	--	16	10d 16d	6	10d	1760 2070	1975 2345	2130 2535	975		
	HUS410	HUS410	14	3-5/8	8-7/8	2	1	--	8	16d	8	16d	1905	2170	2340	1935		
	HUS410IF	HUSC410	14	3-5/8	8-7/8	2	1	--	8	16d	8	16d	1905	2170	2340	1935		
	HD410	HU410	14	3-9/16	8-13/16	2-1/2	1-1/8	Min Max	14 20	16d	6 10	10d	1895 2710	2140 3055	2295 3190	1030 1715		
	HD410IF	HUC410	14	3-9/16	8-13/16	2-1/2	--	Min Max	14 20	16d	6 10	10d	1895 2710	2140 3055	2295 3190	1030 1715		
	HDQ410IF	HUCQ410	14	3-9/16	9	3	1-1/2	--	12	WS3	6	WS3	4480	4590	4590	2655		
	HUS412	HUS412	14	3-5/8	10-7/8	2	1	--	10	16d	10	16d	2385	2710	2875	2910		
	HUS412IF	HUSC412	14	3-5/8	10-7/8	2	1	--	10	16d	10	16d	2385	2710	2875	2910		
	HD412	HU412	14	3-9/16	10-13/16	2-1/2	1-1/8	Min Max	16 24	16d	8 12	10d	2165 3250	2445 3665	2620 3860	1040 2060		
	HD412IF	HUC412	14	3-9/16	10-13/16	2-1/2	--	Min Max	16 24	16d	8 12	10d	2165 3250	2445 3665	2620 3860	1040 2060		
	HDQ412IF	HUCQ412	14	3-9/16	11	3	1-1/2	--	14	WS3	6	WS3	5605	5605	5605	3280		
4 x 14	JUS414	LUS414	18	3-5/8	12-7/8	2	1	--	12	16d	6	16d	1920	1920	1920	1870		
	SUH414	U414	16	3-9/16	10-1/16	2	1-1/8	--	18	10d 16d	6	10d	1980 2325	2220 2640	2395 2850	975		
	HD410	HU410	14	3-9/16	8-13/16	2-1/2	1-1/8	Min Max	14 20	16d	6 10	10d	1895 2710	2140 3055	2295 3190	1030 1715		
	HD410IF	HUC410	14	3-9/16	8-13/16	2-1/2	--	Min Max	14 20	16d	6 10	10d	1895 2710	2140 3055	2295 3190	1030 1715		
	HDQ410IF	HUCQ410	14	3-9/16	9	3	1-1/2	--	12	WS3	6	WS3	4480	4590	4590	2655		
	HUS412	HUS412	14	3-5/8	10-7/8	2	1	--	10	16d	10	16d	2385	2710	2875	2910		
	HUS412IF	HUSC412	14	3-5/8	10-7/8	2	1	--	10	16d	10	16d	2385	2710	2875	2910		
	HDQ412IF	HUCQ412	14	3-9/16	11	3	1-1/2	--	14	WS3	6	WS3	5605	5605	5605	3280		
	HD412	HU412	14	3-9/16	10-13/16	2-1/2	1-1/8	Min Max	16 24	16d	8 12	10d	2165 3250	2445 3665	2620 3860	1040 2060		
	HD412IF	HUC412	14	3-9/16	10-13/16	2-1/2	--	Min Max	16 24	16d	8 12	10d	2165 3250	2445 3665	2620 3860	1040 2060		
	HD414	HU414	14	3-9/16	12-13/16	2-1/2	1-1/8	Min Max	18 26	16d	8 12	10d	2440 3520	2750 3860	2950 3860	1205 2060		
	HD414IF	HUC414	14	3-9/16	12-13/16	2-1/2	--	Min Max	18 26	16d	8 12	10d	2440 3520	2750 3860	2950 3860	1205 2060		
4 x 16	JUS414	LUS414	18	3-5/8	12-7/8	2	1	--	12	16d	6	16d	1920	1920	1920	1870		
	SUH414	U414	16	3-9/16	10-1/16	2	1-1/8	--	18	10d 16d	6	10d	1980 2325	2220 2640	2395 2850	975		
	HD412	HU412	14	3-9/16	10-13/16	2-1/2	1-1/8	Min Max	16 24	16d	8 12	10d	2165 3250	2445 3665	2620 3860	1040 2060		
	HD412IF	HUC412	14	3-9/16	10-13/16	2-1/2	--	Min Max	16 24	16d	8 12	10d	2165 3250	2445 3665	2620 3860	1040 2060		
	HDQ412IF	HUCQ412	14	3-9/16	11	3	1-1/2	--	14	WS3	6	WS3	5605	5605	5605	3280		
	HD414	HU414	14	3-9/16	12-13/16	2-1/2	1-1/8	Min Max	18 26	16d	8 12	10d	2440 3520	2750 3860	2950 3860	1205 2060		
	HD414IF	HUC414	14	3-9/16	12-13/16	2-1/2	--	Min Max	18 26	16d	8 12	10d	2440 3520	2750 3860	2950 3860	1205 2060		
	HD416	HU416	14	3-9/16	14-13/16	2-1/2	1-1/8	Min Max	22 30	16d	10 14	10d	2980 4015	3360 4015	3605 4015	1715 1805		
	HD416IF	HUC416	14	3-9/16	14-13/16	2-1/2	--	Min Max	22 30	16d	10 14	10d	2980 4015	3360 4015	3605 4015	1715 1805		

IBC, FL, LA

Lumber Hangers

Copyright © 2022 MiTek Industries, Inc. All Rights Reserved

- 1) Uplift loads have been increased 60% for wind or seismic loads; no further increase shall be permitted.
 - 2) For JUS and HUS hangers: Nails must be driven at a 30° to 45° angle through the joist or truss into the header to achieve the table loads.
 - 3) MiTek's WS3 structural wood screws are 1/4" dia. x 3" long and are included with HDQIF hangers.
 - 4) **NAILS:** 10d nails are 0.148" dia. x 3" long, 16d nails are 0.162" dia. x 3-1/2" long.
- New products or updated product information are designated in **blue font**.

Corrosion Finish Key ■ Stainless Steel ■ Gold Coat ■ HDG ■ Triple Zinc

Continued on next page

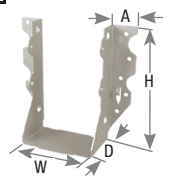

Joist Size	MiTek Stock No.	Ref. No.	Steel Gauge	Dimensions (in)				Fastener Schedule ³				SPF Allowable Loads (Lbs.) ²				Corrosion Finish	Code Ref.		
				W	H	D	A	Min/Max	Header		Joist		Floor		Roof			Uplift ¹	
									Qty	Type	Qty	Type	100%	115%	125%				160%
4 x 18	HD414	HU414	14	3-9/16	12-13/16	2-1/2	1-1/8	Min	18	16d	8	10d	2440	2750	2950	1205			
								Max	26		12		3520	3860	3860	2060			
	HD414IF	HUC414	14	3-9/16	12-13/16	2-1/2	--	Min	18	16d	8	10d	2440	2750	2950	1205			
								Max	26		12		3520	3860	3860	2060			
	HD416	HU416	14	3-9/16	14-13/16	2-1/2	1-1/8	Min	22	16d	10	10d	2980	3360	3605	1715			
								Max	30		14		4015	4015	4015	1805			
	HD416IF	HUC416	14	3-9/16	14-13/16	2-1/2	--	Min	22	16d	10	10d	2980	3360	3605	1715			
								Max	30		14		4015	4015	4015	1805			
	HD418	--	14	3-9/16	16-1/2	2-1/2	1-1/4	--	28	16d	8	10d	3795	3835	3835	1375			
	6 x 6	SUH66	U66	16	5-1/2	5	2	1	--	8	10d	4	10d	880	990	1065	665		
									16d	6	1035	1175		1265					
HD66		HU66	14	5-1/2	4-1/16	2-1/2	1-1/8	Min	8	16d	4	16d	1085	1220	1310	685			
								Max	12		6		1625	1835	1965	1035			
HD66IF		HUC66	14	5-1/2	4-1/16	2-1/2	--	Min	8	16d	4	16d	1085	1220	1310	685			
								Max	12		6		1625	1835	1965	1035			
6 x 8	SUH66	U66	16	5-1/2	5	2	1	--	8	10d	4	10d	880	990	1065	665			
									16d	6	1035		1175	1265					
	HD66	HU66	14	5-1/2	4-1/16	2-1/2	1-1/8	Min	8	16d	4	16d	1085	1220	1310	685			
								Max	12		6		1625	1835	1965	1035			
	HD66IF	HUC66	14	5-1/2	4-1/16	2-1/2	--	Min	8	16d	4	16d	1085	1220	1310	685			
								Max	12		6		1625	1835	1965	1035			
	HD68	HU68	14	5-1/2	5-15/16	2-1/2	1-1/8	Min	10	16d	4	16d	1355	1525	1640	760			
								Max	14		6		1895	2140	2295	1035			
	HD68IF	HUC68	14	5-1/2	5-15/16	2-1/2	--	Min	10	16d	4	16d	1355	1525	1640	760			
								Max	14		6		1895	2140	2295	1035			
6 x 10	SUH610	U610	16	5-1/2	9	2	1	--	14	10d	6	10d	1540	1730	1865	970			
									16d	8	1810		2055	2215					
	HD68	HU68	14	5-1/2	5-15/16	2-1/2	1-1/8	Min	10	16d	4	16d	1355	1525	1640	760			
								Max	14		6		1895	2140	2295	1035			
	HD68IF	HUC68	14	5-1/2	5-15/16	2-1/2	--	Min	10	16d	4	16d	1355	1525	1640	760			
								Max	14		6		1895	2140	2295	1035			
	HD610	HU610	14	5-1/2	7-13/16	2-1/2	1-1/8	Min	14	16d	6	16d	1895	2140	2295	1035			
								Max	20		10		2710	3055	3275	2025			
HD610IF	HUC610	14	5-1/2	7-13/16	2-1/2	--	Min	14	16d	6	16d	1895	2140	2295	1035				
							Max	20		10		2710	3055	3275	2025				
HDQ610IF	HUCQ610	14	5-1/2	9	3	1-1/8	--	12	WS3	6	WS3	4480	4565	4565	2645				
6 x 12	SUH610	U610	16	5-1/2	9	2	1	--	14	10d	6	10d	1540	1730	1865	970			
									16d	8	1810		2055	2215					
	HD610	HU610	14	5-1/2	7-13/16	2-1/2	1-1/8	Min	14	16d	6	16d	1895	2140	2295	1035			
								Max	20		10		2710	3055	3275	2025			
	HD610IF	HUC610	14	5-1/2	7-13/16	2-1/2	--	Min	14	16d	6	16d	1895	2140	2295	1035			
								Max	20		10		2710	3055	3275	2025			
	HDQ610IF	HUCQ610	14	5-1/2	9	3	1-1/2	--	12	WS3	6	WS3	4480	4565	4565	2645			
	HD612	HU612	14	5-1/2	9-13/16	2-1/2	1-1/8	Min	16	16d	8	16d	2165	2445	2620	1035			
Max								24	12		3250		3665	3930	2430				
HD612IF	HUC612	14	5-1/2	9-13/16	2-1/2	--	Min	16	16d	8	16d	2165	2445	2620	1035				
							Max	24		12		3250	3665	3930	2430				
HDQ612IF	HUCQ612	14	5-1/2	11	3	1-1/2	--	14	WS3	6	WS3	5605	5605	5605	3280				

IBC, FL, LA

Lumber Hangers

Copyright © 2022 MiTek Industries, Inc. All Rights Reserved

1) Uplift loads have been increased 60% for wind or seismic loads; no further increase shall be permitted.
 2) MiTek's WS3 structural wood screws are 1/4" dia. x 3" long and are included with HDQIF hangers.
 3) NAILS: 10d nails are 0.148" dia. x 3" long, 16d nails are 0.162" dia. x 3-1/2" long.
 New products or updated product information are designated in blue font.

Corrosion Finish Key ■ Stainless Steel ■ Gold Coat ■ HDG ■ Triple Zinc

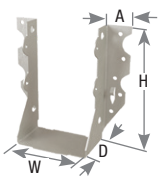

Continued on next page

Joist Size	MiTek Stock No.	Ref. No.	Steel Gauge	Dimensions (in)				Fastener Schedule ³				SPF Allowable Loads (Lbs.) ²				Corrosion Finish	Code Ref.	
				W	H	D	A	Min/Max	Header		Joist		Floor	Roof				Uplift ¹
									Qty	Type	Qty	Type		100%	115%			
6 x 14	HDQ610IF	HUCQ610	14	5-1/2	9	3	1-1/2	--	12	WS3	6	WS3	4480	4565	4565	2645		
	HD612	HU612	14	5-1/2	9-13/16	2-1/2	1-1/8	Min	16	16d	8	16d	2165	2445	2620	1035		
								Max	24		12		3250	3665	3930	2430		
	HD612IF	HUC612	14	5-1/2	9-13/16	2-1/2	--	Min	16	16d	8	16d	2165	2445	2620	1035		
								Max	24		12		3250	3665	3930	2430		
	HDQ612IF	HUCQ612	14	5-1/2	11	3	1-1/2	--	14	WS3	6	WS3	5605	5605	5605	3280		
HD614	HU614	14	5-1/2	11-13/16	2-1/2	1-1/8	Min	18	16d	8	16d	2440	2750	2950	1620			
							Max	26		12		3520	3970	4020	2430			
HD614IF	HUC614	14	5-1/2	11-13/16	2-1/2	--	Min	18	16d	8	16d	2440	2750	2950	1620			
							Max	26		12		3520	3970	4020	2430			
6 x 16	HD612	HU612	14	5-1/2	9-13/16	2-1/2	1-1/8	Min	16	16d	8	16d	2165	2445	2620	1035		
								Max	24		12		3250	3665	3930	2430		
	HD612IF	HUC612	14	5-1/2	9-13/16	2-1/2	--	Min	16	16d	8	16d	2165	2445	2620	1035		
								Max	24		12		3250	3665	3930	2430		
	HDQ612IF	HUCQ612	14	5-1/2	11	3	1-1/2	--	14	WS3	6	WS3	5605	5605	5605	3280		
	HD614	HU614	14	5-1/2	11-13/16	2-1/2	1-1/8	Min	18	16d	8	16d	2440	2750	2950	1620		
								Max	26		12		3520	3970	4020	2430		
HD614IF	HUC614	14	5-1/2	11-13/16	2-1/2	--	Min	18	16d	8	16d	2440	2750	2950	1620			
							Max	26		12		3520	3970	4020	2430			
HD616	HU616	14	5-1/2	13-13/16	2-1/2	1-1/8	Min	22	16d	10	16d	2980	3360	3605	2025			
							Max	30		14		3990	3990	3990	2835			
HD616IF	HUC616	14	5-1/2	13-13/16	2-1/2	--	Min	22	16d	10	16d	2980	3360	3605	2025			
							Max	30		14		3990	3990	3990	2835			
6 x 18	HD614	HU614	14	5-1/2	11-13/16	2-1/2	1-1/8	Min	18	16d	8	16d	2440	2750	2950	1620		
								Max	26		12		3520	3970	4020	2430		
	HD614IF	HUC614	14	5-1/2	11-13/16	2-1/2	--	Min	18	16d	8	16d	2440	2750	2950	1620		
								Max	26		12		3520	3970	4020	2430		
HD616	HU616	14	5-1/2	13-13/16	2-1/2	1-1/8	Min	22	16d	10	16d	2980	3360	3605	2025			
							Max	30		14		3990	3990	3990	2835			
HD616IF	HUC616	14	5-1/2	13-13/16	2-1/2	--	Min	22	16d	10	16d	2980	3360	3605	2025			
							Max	30		14		3990	3990	3990	2835			
8 x 6	HD86	--	14	7-1/2	4-15/16	2-1/2	1-1/2	Min	8	16d	4	16d	1085	1220	1310	685		
								Max	10		4		1355	1525	1640	760		
HD86IF	--	14	7-1/2	5-1/8	2-1/2	--	--	10	16d	4	16d	1355	1525	1640	760			
8 x 8	HD88	HU88	14	7-1/2	6-13/16	2-1/2	1-1/2	Min	10	16d	4	16d	1355	1525	1640	760		
								Max	14		6		1895	2140	2295	1030		
	HD88IF	HUC88	14	7-1/2	6-13/16	2-1/2	--	Min	10	16d	4	16d	1355	1525	1640	760		
								Max	14		6		1895	2140	2295	1030		

IBC, FL, LA

Copyright © 2022 MiTek Industries, Inc. All Rights Reserved

- 1) Uplift loads have been increased 60% for wind or seismic loads; no further increase shall be permitted.
- 2) MiTek's WS3 structural wood screws are 1/4" dia. x 3" long and are included with HDQIF hangers.
- 3) **NAILS:** 10d x 1-1/2 nails are 0.148" dia. x 1-1/2" long, 10d nails are 0.148" dia. x 3" long, 16d nails are 0.162" dia. x 3-1/2" long. New products or updated product information are designated in **blue font**.

Corrosion Finish Key ■ Stainless Steel ■ Gold Coat ■ HDG ■ Triple Zinc

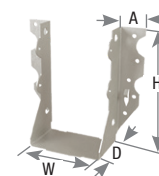

Continued on next page

Joist Size	MiTek Stock No.	Ref. No.	Steel Gauge	Dimensions (in)				Fastener Schedule ²				SPF Allowable Loads (Lbs.)				Code Ref.	
				W	H	D	A	Header		Joist		Allowable Loads (Lbs.)					
								Min/Max	Qty	Type	Qty	Type	Floor	Roof	Uplift ¹		
100%	115%	125%	160%														
8 x 10	HD810	HU810	14	7-1/2	8-9/16	2-1/2	1-1/2	Min	14	16d	6	16d	1895	2140	2295	1030	IBC, FL, LA
								Max	18		8		2440	2750	2950	1620	
	HD810IF	HUC810	14	7-1/2	8-9/16	2-1/2	--	Min	14	16d	6	16d	1895	2140	2295	1030	
								Max	18		8		2440	2750	2950	1620	
8 x 12	HD812	HU812	14	7-1/2	10-1/2	2-1/2	1-1/2	Min	16	16d	6	16d	2165	2445	2620	1030	
								Max	22		8		2980	3360	3605	1620	
	HD812IF	HUC812	14	7-1/2	10-1/2	2-1/2	--	Min	16	16d	6	16d	2165	2445	2620	1030	
								Max	22		8		2980	3360	3605	1620	
8 x 14	HD814	HU814	14	7-1/2	11-13/16	2-1/2	1-1/2	Min	18	16d	8	16d	2440	2750	2950	1620	
								Max	24		12		3250	3665	3885	2430	
	HD814IF	HUC814	14	7-1/2	11-13/16	2-1/2	--	Min	18	16d	8	16d	2440	2750	2950	1620	
								Max	24		12		3250	3665	3885	2430	
8 x 16	HD816	HU816	14	7-1/2	12-13/16	2-1/2	1-1/2	Min	20	16d	8	16d	2710	3055	3155	1620	
								Max	26		12		3520	3885	3885	2430	
	HD816IF	HUC816	14	7-1/2	13-5/8	2-1/2	--	Min	26	16d	12	16d	3520	3885	3885	2430	
								Max	26		12		3520	3885	3885	2430	
ROUGH LUMBER SIZES																	
2 x 4	SUH24R	LU24R-18, U24R	16	2	3-1/16	2	1-1/8	--	4	10d	2	10d x 1-1/2	440	495	530	310	
										16d			515	585	635		
2 x 6 - 8	SUH26R	LU26R-18, U26R	16	2	4-15/16	2	1-3/16	--	6	10d	4	10d x 1-1/2	660	740	800	665	
										16d			775	880	950		
2 x 8 - 10	SUH28R	LU28R-18	16	2	6-7/16	2	1-1/8	--	8	10d	6	10d x 1-1/2	880	990	1055	705	
										16d			1035	1175	1265		
2 x 10 - 12	SUH210R	LU210R-18, U210R	16	2	7-13/16	2	1-1/8	--	10	10d	6	10d x 1-1/2	1100	1235	1330	980	
										16d			1295	1465	1585		
2 x 14 - 16	SUH214R	--	16	2	9-13/16	2	1-1/8	--	12	10d	8	10d x 1-1/2	1320	1480	1595	1330	
										16d			1550	1760	1900		
4 x 4	SUH44R	U44R	16	4	2-11/16	2	1-1/8	--	6	10d	2	16d	660	740	800	370	
										16d			775	880	950		
4 x 6	SUH46R	U46R	16	4	4-11/16	2	1-1/8	--	8	10d	4	16d	880	990	1065	695	
										16d			1035	1175	1265		
4 x 10 - 12	SUH410R	U410R	16	4	8-3/16	2	2	--	14	10d	6	16d	1540	1730	1865	975	
										16d			1810	2055	2215		
6 x 8	SUH66R	U66R	16	6	5	2	1	--	8	10d	4	16d	880	990	1065	690	
										16d			1035	1175	1265		
6 x 10 - 12 - 14	SUH610R	U610R	16	6	9	2	1	--	14	10d	6	16d	1540	1730	1865	970	
										16d			1810	2055	2215		
GLULAM SIZES																	
3-1/8 x 10-1/2 - 19-1/2	HD32105	HU3.25/10.5	14	3-1/4	9-15/16	2-1/2	1-1/8	Min	16	16d	6	10d	2165	2445	2620	945	
								Max	22		10		2980	3360	3605	1715	
3-1/8 x 12 - 21	HD3212	HU3.25/12	14	3-1/4	11-7/8	2-1/2	1-1/8	Min	18	16d	8	10d	2440	2750	2950	1205	
								Max	26		12		3520	3970	4045	2060	
5-1/8 x 10-1/2 - 19-1/2	HD5112	HU5.125/12	14	5-1/4	9-15/16	2-1/2	1-1/8	Min	16	16d	8	16d	2165	2445	2620	1040	
								Max	24		12		3250	3625	3625	2430	
5-1/8 x 14-1/2 - 21	HD51135	HU5.125/13.5	14	5-1/4	12-15/16	2-1/2	1-1/8	Min	20	16d	10	16d	2710	3055	3175	2025	
								Max	28		14		3795	4030	4030	2835	

1) Uplift loads have been increased 60% for wind or seismic loads; no further increase shall be permitted.
 2) **NAILS:** 10d x 1-1/2 nails are 0.148" dia. x 1-1/2" long, 10d nails are 0.148" dia. x 3" long, 16d nails are 0.162" dia. x 3-1/2" long.

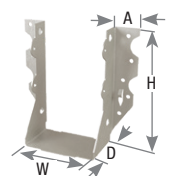

HL Light Gauge Purlin Hangers

These top mount hangers are designed for supporting floor joists or 2x dimensional lumber. The top mount style allows builders to drop in joists or purlins quickly.

Materials: 18 gauge

Finish: G90 galvanizing

Codes: IBC, FL, LA

Installation:

- Use all specified fasteners. See Product Notes, page 18.



Typical HL210 installation

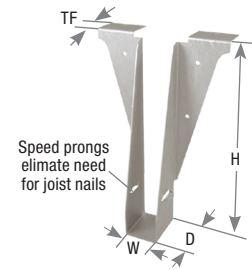

HL210

KB / KLB Beam & Purlin Hangers

With a top mount design and heavy steel fabrication the KB and KLB hangers can cover medium-to-heavy beam and purlin applications. The top mount design offers high loads with less nailing than comparable face mount hangers.

KLB – 14 gauge

KB – 12 gauge

Materials: See chart

Finish: G90 galvanizing

Options: See chart for Corrosion Finish Options

Codes: IBC, FL, LA

Installation:

- Use all specified fasteners. See Product Notes, page 18.
- NA20D nails are included with hangers where applicable.
- For welded installations, see page 325.
- **KB models are not recommended for use with LVL, PSL, or LSL members.**



Typical KB installation



Typical KLB installation

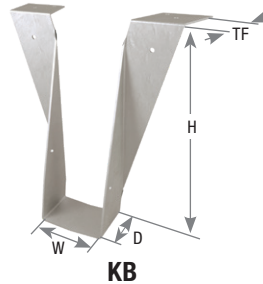

KB

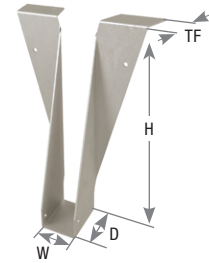

KLB

HDO Heavy-Duty Top Mount Hangers

Lumber Hangers

Primarily used to hang joists or headers in medium load conditions. These hangers provide higher load values with less nailing.

Materials: 12 gauge

Finish: G90 galvanizing

Options: All nominal lumber sizes are available for rough/full size lumber. See Specialty Options Chart.

Codes: IBC, FL, LA

Installation:

- Use all specified fasteners. See Product Notes, page 18.
- Check top flange dimensions to ensure compatibility with header widths.
- **Do not use for welded or nailer applications. Reference Specialty Options chart below for hanger options.**

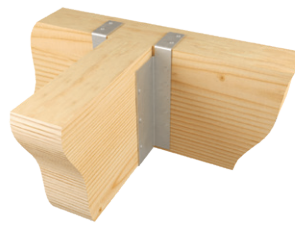

HDO standard installation

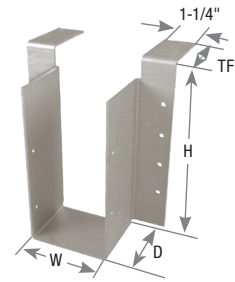

HDO28-2



Typical HDO410IF inverted flange installation



Typical HDO skewed option installation

Specialty Options Chart

Refer to Specialty Options pages 320 and 322 for additional details.

Option	Skewed ^{1,3}	Sloped Seat ²	Sloped / Skewed ^{1,2,3}	Inverted Flange
Range	1° to 67-1/2° when width is 1-3/4" or less. 1° to 50° on all others.	1° to 45°	See Sloped Seat and Skewed	Not available in widths less than 3-1/8"
Allowable Loads	100% of table load. 75% of uplift load on skews greater than 15°.	100% of table load	80% of table load. 75% of uplift load on skews greater than 15°.	100% of table load. 65% of table load when nailing into the support members end grain.
Ordering	Add <i>SK</i> , angle required, right (<i>R</i>) or left (<i>L</i>), and square cut (<i>SQ</i>) or bevel cut (<i>BI</i>) to product number. Ex. HDO210_SK45R_SQ	Add <i>SL</i> , slope required, and up (<i>U</i>) or down (<i>D</i>), to product number. Ex. HDO210_SL30D	See Sloped Seat and Skewed. Ex. HDO210_SK45R_SQ_SL30D	Add <i>IF</i> to product number. Ex. HDO610_IF

1) Skewed hangers with skews greater than 15° may have all joist nailing on outside flange.

2) Sloped or sloped / skewed hangers with slopes greater than 15° may have additional joist nails.

3) For skewed hangers, the required cut type (square or bevel) of joist member may vary based on skew angle and width of hanger. Some square cut hangers will require custom pricing due to welded back plate.

SW – Light-duty hanger

SWH – Medium-duty hanger

KHW – Heavy-duty hanger installs with NA20D nails for higher load capacities

Materials: SW top flange - 12 gauge; stirrup - 12 gauge;
SWH top flange - 7 gauge; stirrup - 12 gauge;
KHW top flange - 3 gauge; stirrup - 10 gauge

Finish: Primer

Options: All nominal lumber sizes are available for rough/ full size lumber. See Specialty Options below.

Codes: IBC, FL, LA

Installation:

- Use all specified fasteners. See Product Notes, page 18.
- NA20D nails are supplied with KHW hangers.
- For welded installations see page 325.
- **KHW models are not recommended for use with LVL, PSL, or LSL headers.**



Typical KHW46 installation



Typical SW210 installation

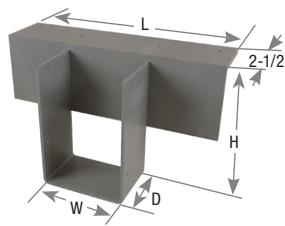

KHW46

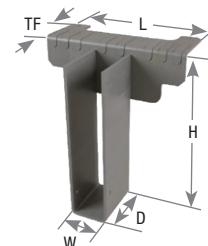

SW210

Nailer Installation Chart

Chart represents maximum allowable loads for hangers used on wood nailers. Reference page 203.

MiTek Series	Nailer Size	Fastener Schedule ⁴				DF/SP Allowable Loads (Lbs.) ^{1,3}		SPF Allowable Loads (Lbs.) ^{1,3}	
		Nailer		Joist		Download 100%	Download 100%	Download 100%	Download 100%
		Top Qty	Type	Qty	Type				
SW ² widths ≥ 2-9/16"	2X	2	10d x 1-1/2	2	10d x 1-1/2	1635		1115	
	3x	2	16d x 2-1/2	2	10d x 1-1/2	2390		2010	
	(2) 2x	2	16d x 2-1/2	2	10d x 1-1/2	2390		2010	
	4x	2	16d x 2-1/2	2	10d x 1-1/2	2390		2010	
SWH	2X	2	10d x 1-1/2	2	10d x 1-1/2	2600		1770	
	3X	2	16d x 2-1/2	2	10d x 1-1/2	3305		2280	
	(2) 2x	2	16d x 2-1/2	2	10d x 1-1/2	3305		2280	
	4x	2	16d x 2-1/2	2	10d x 1-1/2	3305		2280	
KHW	3X	4	16d x 2-1/2	2	10d	4415		3525	

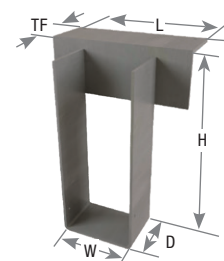

SWH410

- 1) Listed loads shall not be increased.
 - 2) SW hangers with a width of less than 2-9/16" are limited to 2,315 lbs. of download.
 - 3) **Values in the table apply to standard top mount hangers without slope, skew or any other specialty options.**
 - 4) **NAILS:** 10d x 1-1/2 nails are 0.148" dia. x 1-1/2" long, 10d nails are 0.148" dia. x 3" long, 16d x 2-1/2 nails are 0.162" dia. x 2-1/2" long.
- New products or updated product information are designated in **blue font**.

Specialty Options Chart – Refer to Specialty Options pages 320, 322-323 for additional details.

Option	Skewed ^{1,3}	Sloped Seat ²	Sloped / Skewed ^{1,2,3}	Sloped Top Flange ⁴	Top Flange Offset		Saddle	Ridge
Range	1° to 84°	1° to 45°	See Sloped Seat and Skewed	0° to 35°	--		--	0° to 45°
Allowable Loads	100% of table load	100% of table load	100% of table load	100% of table load	Hanger Width 3-1/2" or less 3-9/16" to 5-1/2" 5-9/16" to 7-1/2"	% of table load: 60% 75% 85%	100% of table load per side	100% of table load
Ordering	Add <i>SK</i> , angle required, right (<i>R</i>) or left (<i>L</i>), and square cut (<i>SQ</i>) or bevel cut (<i>BV</i>) to product number. Ex. SW212_SK45R_SQ	Add <i>SL</i> , slope required, and up (<i>U</i>) or down (<i>D</i>), to product number. Ex. SW212_SL30D	See Sloped Seat and Skewed. Ex. SW212_SK45R_SQ_SL30D	Add <i>SLTF</i> , angle required, and right (<i>R</i>) or left (<i>L</i>), to product number. Ex. SW212_SLTF30L	Add <i>OS</i> , and right (<i>R</i>) or left (<i>L</i>), to product number. Ex. SW212_OSL		Add <i>SA</i> , and saddle width required to product number. Ex. SW212_SA=5-1/2"	Add <i>DA</i> , angle required to product number. Ex. SW212_DA30

- 1) Skewed hangers with skews greater than 15° may have all joist nailing on outside flange.
 - 2) Sloped or sloped / skewed hangers with slopes greater than 15° may have additional joist nails.
 - 3) For skewed hangers, the required cut type (square or bevel) of joist member may vary based on skew angle and width of hanger. Some square cut hangers will require custom pricing due to welded back plate.
 - 4) Sloped top flanges with greater than 15° may have additional header nails.
- New products or updated product information are designated in **blue font**.

Top Mount Hanger Charts

Lumber Hangers

Beam/ Joist Size	MiTek Stock No.	Ref. No.	Steel Gauge	Dimensions (in)					Fastener Schedule ⁴					DF/SP Allowable Loads (Lbs.) ³				Corrosion Finish	Code Ref.
				W	H	D	L	TF	Header			Joist		Floor	Roof	Uplift ^{1,2}			
									Qty	Type	Qty	Type							
				Top	Face	Type	Qty	Type	100%	115%	125%	160%							
2 x 4	HDO24	HU24TF	12	1-9/16	3-7/16	2-1/4	--	2-1/2	4	2	16d	2	10d x 1-1/2	2405	2440	2460	330		
2 x 6	HL26	JB26	18	1-9/16	5-3/8	1-1/2	--	1-5/16	2	4	16d	2	prongs	1255	1255	1255	--		
	KLB26	LB26	14	1-9/16	5-3/8	1-1/2	--	1-3/8	2	4	16d	2	10d x 1-1/2	1670	1705	1725	390		
	SW26	--	12	1-9/16	5-3/8	2-1/2	6-1/2	2-1/2	2	--	10d	2	10d x 1-1/2	2315	2315	2315	135		
	HDO26	HU26TF	12	1-9/16	5-3/8	2-1/4	--	2-1/2	4	6	16d	4	10d x 1-1/2	2705	2770	2815	825		
2 x 8	HL28	JB28	18	1-9/16	7-5/16	1-3/4	--	1-5/16	2	4	16d	2	prongs	1490	1490	1490	--		
	KLB28	LB28	14	1-9/16	7-1/4	1-3/4	--	1-3/8	2	4	16d	2	10d x 1-1/2	1905	1935	1960	390		
	SW28	--	12	1-9/16	7-1/8	2-1/2	6-1/2	2-1/2	2	--	10d	2	10d x 1-1/2	2315	2315	2315	135		
	HDO28	HU28TF	12	1-9/16	7-1/8	2-1/4	--	2-1/2	4	6	16d	4	10d x 1-1/2	2705	2770	2815	825		
2 x 10	HL210	JB210A	18	1-9/16	9-5/16	2	--	1-5/16	2	4	16d	2	prongs	1490	1490	1490	--		
	KLB210	LB210A	14	1-9/16	9-1/4	2	--	1-3/8	2	4	16d	2	10d x 1-1/2	2140	2170	2195	390		
	SW210	--	12	1-9/16	9-1/8	2-1/2	6-1/2	2-1/2	2	--	10d	2	10d x 1-1/2	2315	2315	2315	135		
	HDO210	HU210TF	12	1-9/16	9-1/8	2-1/4	--	2-1/2	4	8	16d	4	10d x 1-1/2	2705	2770	2815	825		
2 x 12	HL212	JB212A	18	1-9/16	11-1/4	2-5/16	--	1-5/16	2	4	16d	2	prongs	1490	1490	1490	--		
	KLB212	LB212A	14	1-9/16	11-1/8	2	--	1-3/8	2	4	16d	2	10d x 1-1/2	2140	2170	2195	390		
	SW212	--	12	1-9/16	11-1/8	2-1/2	6-1/2	2-1/2	2	--	10d	2	10d x 1-1/2	2315	2315	2315	135		
	HDO212	HU212TF	12	1-9/16	11	2-1/4	--	2-1/2	4	10	16d	6	10d x 1-1/2	3005	3105	3165	1190		
2 x 14	HL214	JB214A	18	1-9/16	13-1/8	2	--	2-1/2	2	6	16d	2	10d x 1-1/2	1490	1490	1490	250		
	SW214	--	12	1-9/16	13-1/8	2-1/2	6-1/2	2-1/2	2	--	10d	2	10d x 1-1/2	2315	2315	2315	135		
	HDO214	HU214TF	12	1-9/16	13	2-1/4	--	2-1/2	4	12	16d	6	10d x 1-1/2	3005	3105	3140	1190		
2 x 16	SW216	--	12	1-9/16	15-1/8	2-1/2	6-1/2	2-1/2	2	--	10d	2	10d x 1-1/2	2315	2315	2315	135		
	HDO216	HU216TF, LB216	12	1-9/16	15	2-1/4	--	2-1/2	4	14	16d	8	10d x 1-1/2	3300	3435	3520	1700		
3 x 4	HDO34	HU34TF	12	2-9/16	3-7/16	2-1/2	--	2-1/2	4	4	16d	2	10d x 1-1/2	2965	2965	2965	330		
3 x 6	SW36	--	12	2-9/16	5-3/8	2-1/2	6-1/2	2-1/2	2	--	10d	2	10d x 1-1/2	2520	2520	2520	135		
	HDO36	HU36TF	12	2-9/16	5-3/8	2-1/2	--	2-1/2	4	6	16d	4	10d x 1-1/2	4125	4320	4450	825		
3 x 8	SW38	--	12	2-9/16	7-1/8	2-1/2	6-1/2	2-1/2	2	--	10d	2	10d x 1-1/2	2520	2520	2520	135		
	HDO38	HU38TF	12	2-9/16	7-1/8	2-1/2	--	2-1/2	4	8	16d	4	10d x 1-1/2	4465	4570	4575	825		
3 x 10	SW310	--	12	2-9/16	9-1/8	2-1/2	6-1/2	2-1/2	2	--	10d	2	10d x 1-1/2	2520	2520	2520	135		
	HDO310	HU310TF	12	2-9/16	9-1/8	2-1/2	--	2-1/2	4	10	16d	6	10d x 1-1/2	4575	4575	4575	1065		
3 x 12	SWH312	--	7/12	2-9/16	11-1/8	2-1/2	7	2-1/2	2	--	16d	2	10d x 1-1/2	3305	3305	3305	135		
	HDO312	HU312TF	12	2-9/16	11	2-1/2	--	2-1/2	4	12	16d	6	10d x 1-1/2	4800	4900	4965	1115		
3 x 14	SWH314	--	7/12	2-9/16	13-1/8	2-1/2	7	2-1/2	2	--	16d	2	10d x 1-1/2	3305	3305	3305	135		
	HDO314	HU314TF	12	2-9/16	13	2-1/2	--	2-1/2	4	14	16d	8	10d x 1-1/2	5100	5230	5315	1115		
3 x 16	SWH316	--	7/12	2-9/16	15-1/8	2-1/2	7	2-1/2	2	--	16d	2	10d x 1-1/2	3305	3305	3305	135		
	HDO316	HU316TF	12	2-9/16	15	2-1/2	--	2-1/2	4	16	16d	8	10d x 1-1/2	5100	5230	5315	1700		
(2) 2 x 4	HDO24-2	HU24-2TF	12	3-1/8	3-7/16	2-1/4	--	2-1/2	4	4	16d	2	10d	2965	2965	2965	400		
(2) 2 x 6	SWH26-2	WP26-2	7/12	3-1/8	5-3/8	2-1/2	7	2-1/2	2	--	16d	2	10d	3305	3305	3305	135		
	HDO26-2	HU26-2TF, HUS26-2TF	12	3-1/8	5-3/8	2-1/4	--	2-1/2	4	6	16d	4	10d	4125	4320	4450	825		
(2) 2 x 8	SWH28-2	WP28-2	7/12	3-1/8	7-1/8	2-1/2	7	2-1/2	2	--	16d	2	10d	3305	3305	3305	135		
	HDO28-2	HU28-2TF, HUS28-2TF	12	3-1/8	7-1/8	2-1/4	--	2-1/2	4	8	16d	4	10d	4465	4575	4575	825		

IBC,
FL,
LA

Lumber Hangers

Copyright © 2022 MiTek Industries, Inc. All Rights Reserved

- Uplift Loads have been increased 60% for wind or seismic loads; no further increase shall be permitted.
- HL products do not provide uplift resistance, except for the HL214.
- Refer to the respective Nailer Options chart on page 168 for hangers installed on wood nailers.
- NAILS:** 10d x 1-1/2 nails are 0.148" dia. x 1-1/2" long, 10d nails are 0.148" dia. x 3" long, 16d nails are 0.162" dia. x 3-1/2" long.

Corrosion Finish Key ■ Stainless Steel ■ Gold Coat ■ HDG ■ Triple Zinc

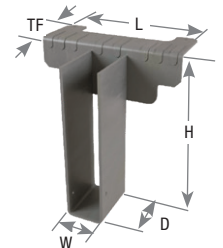

Continued on next page

Beam/ Joist Size	MiTek Stock No.	Ref. No.	Steel Gauge	Dimensions (in)					Fastener Schedule ⁴					DF/SP Allowable Loads (Lbs.) ^{2,3}				Code Ref.	
				W	H	D	L	TF	Header		Joist			Floor		Roof			Uplift ¹
									Qty	Face	Type	Qty	Type	100%	115%	125%	160%		
(2) 2 x 10	SWH210-2	WP210-2	7/12	3-1/8	9-1/8	2-1/2	7	2-1/2	2	--	16d	2	10d	3305	3305	3305	135	IBC, FL, LA	
	HDO210-2	HU210-2TF, HUS210-2TF	12	3-1/8	9-1/8	2-1/4	--	2-1/2	4	10	16d	6	10d	4575	4575	4575	1275		
	HDO210-2IF	HUC210-2TF, HUSC210-2TF	12	3-1/8	9-1/8	2-1/4	--	2-1/2	4	10	16d	6	10d	4575	4575	4575	1275		
(2) 2 x 12	SWH212-2	WP212-2	7/12	3-1/8	11-1/8	2-1/2	7	2-1/2	2	--	16d	2	10d	3305	3305	3305	135		
	HDO212-2	HU212-2TF, HUS212-2TF	12	3-1/8	11	2-1/2	--	2-1/2	4	12	16d	6	10d	5155	5465	5675	1275		
(2) 2 x 14	SWH214-2	WP214-2	7/12	3-1/8	13-1/8	2-1/2	7	2-1/2	2	--	16d	2	10d	3305	3305	3305	135		
	HDO214-2	HU214-2TF, HUS214-2TF	12	3-1/8	13	2-1/2	--	2-1/2	4	14	16d	8	10d	5500	5845	6080	1510		
(2) 2 x 16	SWH216-2	WP216-2	7/12	3-1/8	15-1/8	2-1/2	7	2-1/2	2	--	16d	2	10d	3305	3305	3305	135		
	HDO216-2	HU216-2TF	12	3-1/8	15	2-1/2	--	2-1/2	4	16	16d	8	10d	5845	6010	6100	1700		
4 x 4	HDO44	HU44TF	12	3-9/16	3-7/16	2-1/4	--	2-1/2	4	4	16d	2	10d	2965	2965	2965	400		
4 x 6	SW46	WP46	12	3-9/16	5-3/8	2-1/2	6-1/2	2-1/2	2	--	10d	2	10d	2520	2520	2520	135		
	HDO46	HU46TF	12	3-9/16	5-3/8	2-1/4	--	2-1/2	4	6	16d	4	10d	4125	4320	4450	825		
	KHW46	--	3/10	3-9/16	5-3/8	2-1/2	10	2-1/2	4	--	NA20D	2	10d	5535	5535	5535	135		
4 x 8	SW48	WP48	12	3-9/16	7-1/8	2-1/2	6-1/2	2-1/2	2	--	10d	2	10d	2520	2520	2520	135		
	HDO48	BA48, HU48TF	12	3-9/16	7-1/8	2-1/4	--	2-1/2	4	8	16d	4	10d	4465	4575	4575	825		
	KHW48	--	3/10	3-9/16	7-1/8	2-1/2	10	2-1/2	4	--	NA20D	2	10d	5535	5535	5535	135		
4 x 10	SW410	--	12	3-9/16	9-1/8	2-1/2	6-1/2	2-1/2	2	--	10d	2	10d	2520	2520	2520	135		
	HDO410	BA410, HU410TF	12	3-9/16	9-1/8	2-1/4	--	2-1/2	4	10	16d	6	10d	4785	4785	4785	1275		
	SWH410	WP410	7/12	3-9/16	9-1/8	2-1/2	7	2-1/2	2	--	16d	2	10d	3305	3305	3305	135		
	KHW410	--	3/10	3-9/16	9-1/8	2-1/2	10	2-1/2	4	--	NA20D	2	10d	5535	5535	5535	135		
4 x 12	KB412	--	12	3-9/16	11-1/8	2-3/8	--	2-1/2	4	2	NA20D	2	NA20D	4075	4155	4185	580		
	HDO412	HU412TF	12	3-9/16	11	2-1/4	--	2-1/2	4	12	16d	6	10d	5155	5465	5675	1275		
	SWH412	WP412	7/12	3-9/16	11-1/8	2-1/2	7	2-1/2	2	--	16d	2	10d	3305	3305	3305	135		
	KHW412	--	3/10	3-9/16	11-1/8	2-1/2	10	2-1/2	4	--	NA20D	2	10d	5535	5535	5535	135		
4 x 14	HDO414	HU414TF	12	3-9/16	13	2-1/2	--	2-1/2	4	14	16d	8	10d	5500	5845	6080	1510		
	SWH414	WP414	7/12	3-9/16	13-1/8	2-1/2	7	2-1/2	2	--	16d	2	10d	3305	3305	3305	135		
	KHW414	--	3/10	3-9/16	13-1/8	2-1/2	10	2-1/2	4	--	NA20D	2	10d	5535	5535	5535	135		
4 x 16	HDO416	HU416TF	12	3-9/16	15	2-1/2	--	2-1/2	4	16	16d	8	10d	5845	6230	6460	1700		
	SWH416	WP416	7/12	3-9/16	15-1/8	2-1/2	7	2-1/2	2	--	16d	2	10d	3305	3305	3305	135		
	KHW416	--	3/10	3-9/16	15-1/8	2-1/2	10	2-1/2	4	--	NA20D	2	10d	5535	5535	5535	135		

- 1) Uplift Loads have been increased 60% for wind or seismic loads; no further increase shall be permitted.
- 2) KHW Glulam load values are based on 560 psi perpendicular to grain loading.
- 3) Refer to the respective Nailer Options chart on page 168 for hangers installed on wood nailers.
- 4) **NAILS:** 10d nails are 0.148" dia. x 3" long, 16d nails are 0.162" dia. x 3-1/2" long, NA20D nails are 0.192" dia. x 2-1/2" long and are included with KB and KHW hangers.

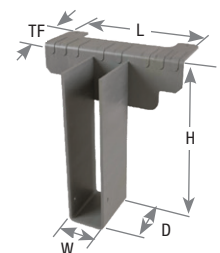

Continued on next page

Beam/ Joist Size	MiTek Stock No.	Ref. No.	Steel Gauge	Dimensions (in)					Fastener Schedule ⁵					DF/SP Allowable Loads (Lbs.) ^{2,3}				Code Ref.	
				W	H	D	L	TF	Header		Joist			Floor		Roof			Uplift ¹ 160%
									Qty	Type	Qty	Type	100%	115%	125%				
																Top	Face		
(3) 2 x 10	HD0210-3	HU210-3TF	12	4-11/16	9-1/8	2-1/2	--	2-1/2	4	10	16d	6	16d	4575	4575	4575	1450	IBC, FL, LA	
(3) 2 x 12	HD0212-3	HU212-3TF	12	4-11/16	11	2-1/2	--	2-1/2	4	12	16d	6	16d	5155	5465	5675	1490		
(3) 2 x 14	HD0214-3	HU214-3TF	12	4-11/16	13	2-1/2	--	2-1/2	4	14	16d	8	16d	5500	5845	6080	1985		
(3) 2 x 16	HD0216-3	HU216-3TF	12	4-11/16	15	2-1/2	--	2-1/2	4	16	16d	8	16d	5845	6230	6460	1985		
6 x 6	HDO66	HU66TF	12	5-1/2	5-3/8	2-1/2	--	2-1/2	4	6	16d	4	16d	4125	4320	4450	990		
	SWH66	WP66	7/12	5-1/2	5-3/8	2-1/2	7	2-1/2	2	--	16d	2	10d	3305	3305	3305	135		
	KHW66	--	3/10	5-1/2	5-3/8	2-1/2	10	2-1/2	4	--	NA20D	2	10d	5535	5535	5535	135		
6 x 8	HDO68	HU68TF	12	5-1/2	7-1/8	2-1/2	--	2-1/2	4	8	16d	4	16d	4465	4575	4575	990		
	SWH68	WP68	7/12	5-1/2	7-1/8	2-1/2	7	2-1/2	2	--	16d	2	10d	3305	3305	3305	135		
	KHW68	--	3/10	5-1/2	7-1/8	2-1/2	10	2-1/2	4	--	NA20D	2	10d	5535	5535	5535	135		
6 x 10	KB610	--	12	5-1/2	9-1/4	2-3/8	--	2-1/2	4	6	NA20D	2	NA20D	4795	4920	4920	580		
	HDO610	HU610TF	12	5-1/2	9-1/8	2-1/2	--	2-1/2	4	10	16d	6	16d	4575	4575	4575	1450		
	SWH610	WP610	7/12	5-1/2	9-1/8	2-1/2	7	2-1/2	2	--	16d	2	10d	3305	3305	3305	135		
	KHW610	--	3/10	5-1/2	9-1/8	2-1/2	10	2-1/2	4	--	NA20D	2	10d	5535	5535	5535	135		
6 x 12	KB612	--	12	5-1/2	11-1/8	2-3/8	--	2-1/2	4	6	NA20D	2	NA20D	4795	4920	4920	580		
	HDO612	HU612TF	12	5-1/2	11	2-1/2	--	2-1/2	4	12	16d	6	16d	5155	5465	5675	1365		
	KHW612	--	3/10	5-1/2	11-1/8	2-1/2	10	2-1/2	4	--	NA20D	2	10d	5535	5535	5535	135		
6 x 14	HDO614	HU614TF	12	5-1/2	13	2-1/2	--	2-1/2	4	14	16d	8	16d	5500	5845	6080	1510		
	KHW614	--	3/10	5-1/2	13-1/8	2-1/2	10	2-1/2	4	--	NA20D	2	10d	5535	5535	5535	135		
6 x 16	HDO616	HU616TF	12	5-1/2	15	2-1/2	--	2-1/2	4	16	16d	8	16d	5845	6230	6460	1830		
	KHW616	--	3/10	5-1/2	15-1/8	2-1/2	10	2-1/2	4	--	NA20D	2	10d	5535	5535	5535	135		
8 x 6	KHW86	--	3/10	7-1/2	5-3/8	2-1/2	10	2-1/2	4	--	NA20D	2	10d	5535	5535	5535	135		
8 x 8	KHW88	--	3/10	7-1/2	7-1/8	2-1/2	10	2-1/2	4	--	NA20D	2	10d	5535	5535	5535	135		
8 x 10	KHW810	--	3/10	7-1/2	9-1/8	2-1/2	10	2-1/2	4	--	NA20D	2	10d	5535	5535	5535	135		
8 x 12	KHW812	--	3/10	7-1/2	11-1/8	2-1/2	10	2-1/2	4	--	NA20D	2	10d	5535	5535	5535	135		
8 x 14	KHW814	--	3/10	7-1/2	13-1/8	2-1/2	10	2-1/2	4	--	NA20D	2	10d	5535	5535	5535	135		
8 x 16	KHW816	--	3/10	7-1/2	15-1/8	2-1/2	10	2-1/2	4	--	NA20D	2	10d	5535	5535	5535	135		
GLULAM SIZES⁴																			
2-1/2 glulam	KHW26	--	3/10	2-11/16	specify	4	10	2-1/2	4	--	NA20D	2	10d x 1-1/2	5295	5295	5295	135	IBC, FL, LA	
3-1/8 glulam	KHW3	--	3/10	3-1/4	specify	3	10	2-1/2	4	--	NA20D	2	10d	5535	5535	5535	135		
5-1/8 glulam	KHW5	--	3/10	5-1/4	specify	2-1/2	10	2-1/2	4	--	NA20D	2	10d	5535	5535	5535	135		

- Uplift Loads have been increased 60% for wind or seismic loads; no further increase shall be permitted.
- KHW Glulam load values are based on 560 psi perpendicular to grain loading.
- Refer to the respective Nailor Options chart on page 168 for hangers installed on wood nailers.
- Consult MiTek for additional Glulam sizes.**
- NAILS:** 10d x 1-1/2 nails are 0.148" dia. x 1-1/2" long, 16d nails are 0.162" dia. x 3-1/2" long, NA20D nails are 0.192" dia. x 2-1/2" long and are included with KHW hangers.

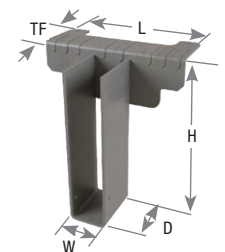

JH Multi-Purpose Strap Hanger

Lumber Hangers

These strap-style hangers are designed to support trusses, joists, or purlins. JH models may be bent along the flange allowing builders to use the hangers in top mount, face mount, or combination applications.

Materials: 18 gauge

Finish: G90 galvanizing

Codes: IBC, FL, LA

Installation:

- Use all specified fasteners. See Product Notes, page 18.
- Joist nails must be driven at a 30° to 45° angle through the joist or truss into the header to achieve listed loads. **Slant/double shear nails must be used to achieve listed load values.**
- If installing in top mount configuration, field bend top flange over header.
- 16d sinkers (0.148" dia. x 3-1/4") may be used where 10d common are specified with no load reduction.



Typical JH20 installation

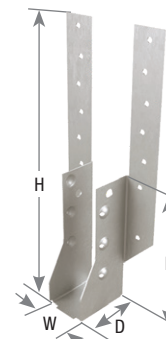

JH20

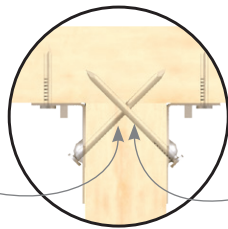

Double shear nail design features fewer nails and faster installation

Uses standard length common nails

Joist Size	MiTek Stock No.	Ref. No.	Steel Gauge	Dimensions (in)					Header Size	Fastener Schedule ^{2,3}					DF/SP Allowable Loads (Lbs.)				Code Ref.
				W	H	D	B	TF		Header		Joist			Floor	Roof		Uplift ¹	
										Top Qty	Face Qty	Type	Qty	Type		100%	115%		
				1-3/16	2 x 6	2	4	10d		6	10d	1910	2070	2175	1300				
2 x 6 - 12	JH20	--	18	1-9/16	10-1/16	2-1/4	5-1/8	1-3/16	2 x 6	2	4	10d	6	10d	1910	2070	2175	1300	IBC, FL, LA
								1-7/16	2 x 8	2	8	10d	6	10d	2555	2780	2935	1300	
								7/16	2 x 10	2	12	10d	6	10d	2295	2595	2790	1300	
								--	2 x 12	--	14	10d	6	10d	2210	2545	2765	1300	

1) Uplift Loads have been increased 60% for wind or seismic loads; no further increase shall be permitted.

2) Nails must be driven at a 30° to 45° angle through the joist or truss into header to achieve the table loads.

3) **NAILS:** 10d nails are 0.148" dia. x 3" long. 16d sinkers (0.148" dia. x 3-1/4" long) may be used where 10d commons are specified with no reduction in load.

RR Ridge Rafter Hanger

Lumber Hangers

The RR Ridge Rafter supports rafter pitches up to 7:12 (30°). Nesting top flange for back-to-back installation on 2x support beams.

Materials: 18 gauge
Finish: G90 galvanizing

- Installation:**
- Use all specified fasteners. See Product Notes, page 18.
 - The rafter end at the ridge must be plumb cut to achieve published loads.
 - Optional diamond nail holes can be used to fasten RR to end of rafter before setting rafter into place.

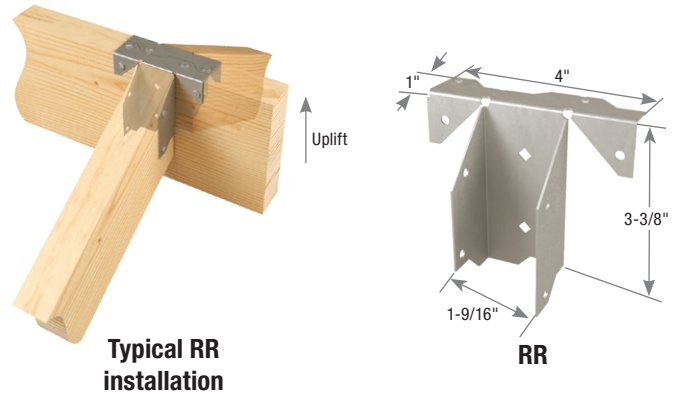

MiTek Stock No.	Ref. No.	Steel Gauge	Min Rafter Size	Fastener Schedule ²				DF/SP Allowable Loads (Lbs.) ¹				S-P-F Allowable Loads (Lbs.) ¹				Code Ref.
				Header		Rafter		Download				Uplift				
				Qty	Type	Qty	Type	100%	115%	125%	160%	100%	115%	125%	160%	
RR	RR	18	2 x 6	4	10d x 1-1/2	4	10d x 1-1/2	365	365	365	205	290	290	290	160	--
				4	LL915	4	LL915	380	380	380	180	320	320	320	150	

1) Allowable loads have been increased 60% for wind or seismic loads; no further increase shall be permitted.
 2) **NAILS:** 10d x 1-1/2 nails are 0.148" dia. x 1-1/2" long and LL915 denotes a MiTek LumberLok Screw, #9 x 1-3/8" long.

LS Light Slope Rafter Hangers

A field-adjustable seat gives the LS hanger application flexibility. The LS hanger slopes from 0° to 30° down (0 to 7:12 pitch down).

Materials: 18 gauge
Finish: G90 galvanizing
Codes: IBC, FL, LA

- Installation:**
- Use all specified fasteners. See Product Notes, page 18.
 - The LS can be field adjusted to slopes from 0° to 30° down.

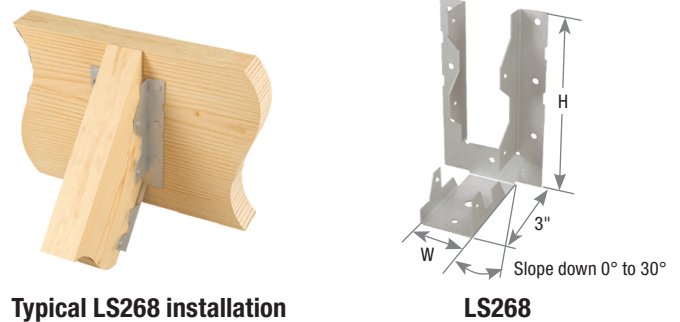

Joist Size	MiTek Stock No.	Ref. No.	Steel Gauge	Dimensions (in)		Fastener Schedule ²				DF/SP Allowable Loads (Lbs.)				S-P-F Allowable Loads (Lbs.)				Code Ref.
				W	H	Header		Joist		Download				Uplift ¹				
						Qty	Type	Qty	Type	100%	115%	125%	160%	100%	115%	125%	160%	
2 x 6 - 8	LS268	--	18	1-9/16	5-1/2	7	10d x 1-1/2	7	10d x 1-1/2	840	960	1035	660	740	850	925	530	IBC, FL, LA
						7	16d	1000	1135	1170	660	880	940	940	530			
2 x 10	LS210	--	18	1-9/16	7-7/8	9	10d x 1-1/2	9	10d x 1-1/2	1080	1230	1330	1035	950	1085	1085	835	
						9	16d	1285	1350	1350	1035	1085	1085	1085	835			

1) Uplift loads are increased 60% for wind or seismic loads; no further increase shall be permitted.
 2) **NAILS:** 10d x 1-1/2 nails are 0.148" dia. x 1-1/2" long, 16d nails are 0.162" dia. x 3-1/2" long.

LSSH Slope/Skew Hangers

Lumber Hangers

The LSSH series connects rafters to ridge beams in vaulted roof structures. This series is field adjustable to meet a variety of skew and/or slope applications. Slopes and skews 0° to 45°.

Materials: See chart

Finish: G-185 galvanizing

Options: See Chart for Corrosion Finish Options

Codes: IBC, FL, LA

Installation:

- Use all specified fasteners. See Product Notes, page 18.

Steps:

1. Position LSSH connector against plumb-cut end of joist. Fasten joist side flanges on both sides with 10d (0.148") x 1-1/2" nails. Bend seat up to fit against joist bottom and drive (1) 10d (0.148") x 1-1/2" nail through bottom seat into rafter bottom. Drive (2) 10d (0.148") x 1-1/2" nails at downward angle through dimpled nailing guides.
2. Lean connector and rafter end against ridge beam at desired position. Install specified 10d (0.148" dia. x 3") or 16d (0.162 x 3-1/2") nails through nail holes into ridge beam at right 90° angle. If skewing the rafter, only drive nails into ridge beam on inside flange.
3. Bend flange to desired angle.
4. Hammer outside flange until edge touches header. Fasten outside flange to ridge by driving specified 10d (0.148" dia. x 3") or 16d (0.162 x 3-1/2") nails through nail holes.

- Web stiffeners are required for all wood I-Joist installations.
- Designer may consider adding a tension restraint for the supported member for roof slopes exceeding 6/12. Refer to page 122.



Typical LSSH179-TZ installation

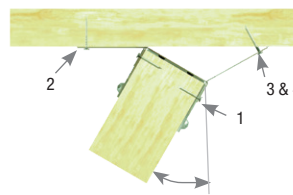

Skew to 45° maximum

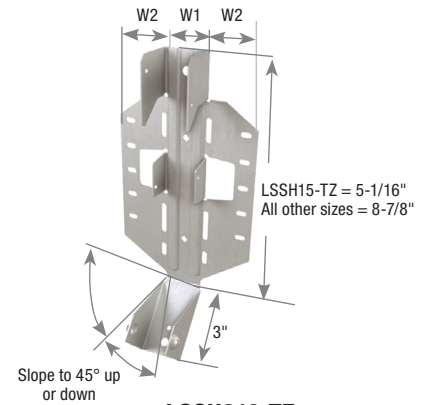

LSSH210-TZ

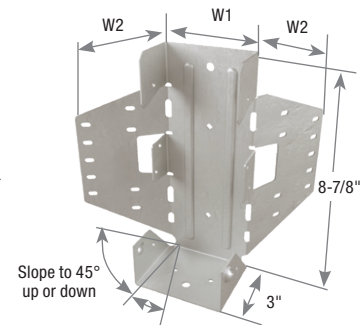

LSSH35-TZ

Rafter Width (in)	MiTek Stock No.	Ref. No.	Steel Gauge	Dimensions (in)		Fastener Schedule ^{2,3,4}				DF/SP Allowable Loads (Lbs.)				S-P-F Allowable Loads (Lbs.)				Corrosion Finish	Code Ref.
				W1	W2	Header		Rafter		Floor	Roof	Uplift ¹	Floor	Roof	Uplift ¹				
						Qty	Type	Qty	Type							100%	115%		
SLOPED ONLY HANGERS																			
1-1/2	LSSH15-TZ	--	18	1-9/16	1-3/4	6	10d	7	10d x 1-1/2	720	820	885	565	640	730	785	440		IBC, FL, LA
1-1/2	LSSH210-TZ	--	18	1-9/16	1-3/4	10	10d	7	10d x 1-1/2	1200	1370	1395	410	1065	1090	1090	320		
1-3/4	LSSH179-TZ	--	18	1-13/16	1-5/8	10	10d	7	10d x 1-1/2	1200	1370	1395	880	1065	1090	1090	690		
2 - 2-1/8	LSSH20-TZ	--	18	2-1/8	2-1/2	10	10d	7	10d x 1-1/2	1200	1370	1395	795	1065	1085	1085	620		
2-1/4 - 2-5/16	LSSH23-TZ	--	18	2-5/16	2-3/8	10	10d	7	10d x 1-1/2	1200	1370	1395	795	1065	1085	1085	620		
2-1/2	LSSH25-TZ	--	16	2-9/16	2-3/4	18	16d	12	10d x 1-1/2	2095	2095	2095	945	1640	1640	1640	740		
2-5/8	LSSH26-TZ	--	16	2-11/16	2-5/8	18	16d	12	10d x 1-1/2	2095	2095	2095	945	1640	1640	1640	740		
3	LSSH31-TZ	--	16	3-1/8	3-3/4	18	16d	12	10d x 1-1/2	2645	3000	3090	1310	2345	2415	2415	1025		
3-1/2	LSSH35-TZ	--	16	3-9/16	3-1/2	18	16d	12	10d x 1-1/2	2645	3000	3090	1310	2345	2405	2405	1020		
SKEWED HANGERS or SLOPED & SKEWED HANGERS																			
1-1/2	LSSH15-TZ	--	18	1-9/16	1-3/4	6	10d	7	10d x 1-1/2	620	620	620	510	485	485	485	400		IBC, FL, LA
1-1/2	LSSH210-TZ	--	18	1-9/16	1-3/4	10	10d	7	10d x 1-1/2	1200	1370	1395	880	1065	1090	1090	690		
1-3/4	LSSH179-TZ	--	18	1-13/16	1-5/8	10	10d	7	10d x 1-1/2	1200	1370	1395	880	1065	1090	1090	690		
2 - 2-1/8	LSSH20-TZ	--	18	2-1/8	2-1/2	10	10d	7	10d x 1-1/2	1200	1230	1230	795	960	960	960	620		
2-1/4 - 2-5/16	LSSH23-TZ	--	18	2-5/16	2-3/8	10	10d	7	10d x 1-1/2	1200	1230	1230	795	955	955	955	620		
2-1/2	LSSH25-TZ	--	16	2-9/16	2-3/4	14	16d	12	10d x 1-1/2	1610	1610	1610	945	1260	1260	1260	740		
2-5/8	LSSH26-TZ	--	16	2-11/16	2-5/8	14	16d	12	10d x 1-1/2	1610	1610	1610	945	1260	1260	1260	740		
3	LSSH31-TZ	--	16	3-1/8	3-3/4	14	16d	12	10d x 1-1/2	1610	1610	1610	1310	1260	1260	1260	1025		
3-1/2	LSSH35-TZ	--	16	3-9/16	3-1/2	14	16d	12	10d x 1-1/2	1610	1610	1610	1310	1255	1255	1255	1020		

- 1) Uplift loads have been increased 60% for wind or seismic loads; no further increase shall be permitted.
- 2) Stainless steel ring shank nails must be used with stainless steel connectors to achieve tabulated allowable loads.
- 3) For exterior applications, hot-dip galvanized (HDG) fasteners must be used.
- 4) **NAILS:** 10d x 1-1/2 nails are 0.148" dia. x 1-1/2" long, 10d nails are 0.148" dia. x 3" long, 16d nails are 0.162" dia. x 3-1/2" long. New products or updated product information are designated in **blue font**.

Corrosion Finish Key

■ Stainless Steel	■ Gold Coat
■ HDG	■ Triple Zinc

SKH / SKHH Skewed 45° Hangers

Lumber Hangers

SKH – Standard 45° skew hanger allows for a 40° to 50° skew range, without hanger modification

SKHH – For heavier applications

Materials: 14 or 16 gauge

Finish: G90 galvanizing

Options: See chart for Corrosion Finish Options

Codes: See chart for code references



SKH26R
right skew

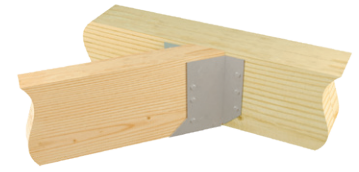

SKH26L
left skew

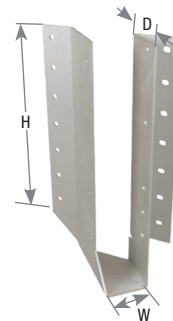

SKH210R

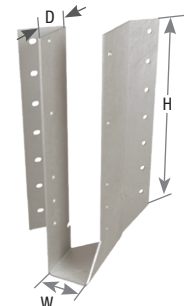

SKH210L

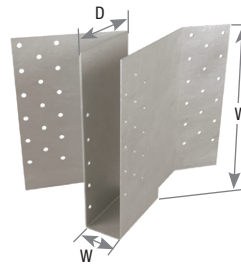

SKHH210L
left skew

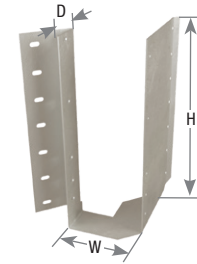

SKHH210L-2
left skew



Typical SKH26L
installation
left skew

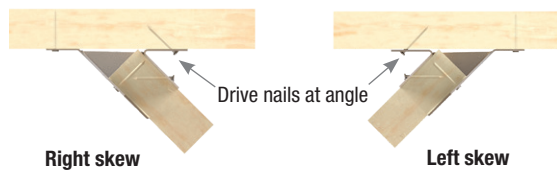

Beam/Joist Size	MiTek Stock No.	Ref. No.	Ga.	Dimensions (in)			Fastener Schedule ²				DF/SP Allowable Loads (Lbs.)				S-P-F Allowable Loads (Lbs.)			Corrosion Finish	Code Ref.	
				W	H	D	Header		Joist		Floor	Roof	Uplift ¹	Floor	Roof	Uplift ¹				
							Qty	Type	Qty	Type										
2 x 4	SKH24L/R	SUR/L24	16	1-9/16	3-1/4	1-7/8	4	16d	4	10d x 1-1/2	510	510	510	545	395	395	395	425		IBC, FL, LA
2 x 6-8	SKH26L/R	SUR/L26	16	1-9/16	5-1/4	1-7/8	6	16d	6	10d x 1-1/2	840	890	890	1135	700	700	700	980		--
	SKHH26L/R	--	16	1-5/8	5-1/8	3-1/4	18	16d	12	10d x 1-1/2	1765	1795	1795	795	1450	1450	1450	645		--
2 x 8-12	SKH28L/R	--	16	1-9/16	7-1/4	1-7/8	10	16d	8	10d x 1-1/2	1400	1465	1465	1350	1160	1160	1160	1070		IBC, FL, LA
	SKHH28L/R	--	16	1-5/8	7	3-1/4	26	16d	16	10d x 1-1/2	2350	2525	2525	1155	2055	2055	2055	940		--
2 x 10-14	SKH210L/R	SUR/L210, SUR/L214	16	1-9/16	9-1/4	1-7/8	14	16d	10	10d x 1-1/2	1790	1790	1790	1530	1425	1425	1425	1220		IBC, FL, LA
	SKHH210L/R	--	16	1-5/8	9	4-1/4	34	16d	20	10d x 1-1/2	2625	2625	2625	1420	2150	2150	2150	1160		--
1-3/4 x 9-1/4 - 14	SKH1720L/R	SUR/L1.81/9	16	1-13/16	9-1/8	1-7/8	14	10d	10	10d x 1-1/2	1650	1760	1760	1530	1400	1400	1400	1220		
1-3/4 x 11-1/4 - 18	SKH1724L/R	SUR/L1.81/11, SUR/L1.81/14	16	1-13/16	11-1/8	1-7/8	16	10d	10	10d x 1-1/2	1890	2170	2360	1530	1635	1880	2035	1220		
2 - 2-1/8 x 9-1/4 - 14	SKH2020L/R	SUR/L2.06/9, SUR/L2.1/9	16	2-1/8	9	1-7/8	14	10d	10	10d x 1-1/2	1650	1760	1760	1530	1390	1390	1390	1210		IBC, FL, LA
2 - 2-1/8 x 11-1/4 - 18	SKH2024L/R	SUR/L2.06/11, SUR/L2.1/11	16	2-1/8	11	1-7/8	16	10d	10	10d x 1-1/2	1890	2170	2360	1530	1635	1880	2020	1210		
2-1/4 - 2-5/16 x 9-1/4 - 14	SKH2320L/R	SUR/L2.37/9	16	2-3/8	8-7/8	1-7/8	14	10d	10	10d x 1-1/2	1650	1760	1760	1530	1390	1390	1390	1210		
2-1/4 - 2-5/16 x 11-1/4 - 18	SKH2324L/R	SUR/L2.37/11, SUR/L2.37/14	16	2-3/8	10-7/8	1-7/8	16	10d	10	10d x 1-1/2	1890	2170	2360	1530	1635	1880	2020	1210		

1) Uplift loads have been increased 60% for wind and seismic loads; no further increase shall be permitted.

2) **NAILS:** 10d x 1-1/2 nails are 0.148" dia. x 1-1/2" long, 16d nails are 0.162" dia. x 3-1/2" long.

*Miter cut required on the end of supported joist.

Corrosion Finish Key

- Stainless Steel
- Gold Coat
- HDG
- Triple Zinc

Continued on next page

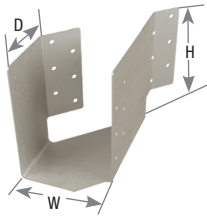

SKHH46LIF left skew



Typical SKH2520R-2 staggered I-joist installation right skew

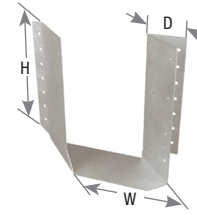

SKH2520R-2 right skew

Beam/Joist Size	MiTek Stock No.	Ref. No.	Ga.	Dimensions (in)			Fastener Schedule ²				DF/SP Allowable Loads (Lbs.)				S-P-F Allowable Loads (Lbs.)				Corrosion Finish	Code Ref.
				W	H	D	Header		Joist		Floor		Roof		Floor		Roof			
							Qty	Type	Qty	Type	100%	115%	125%	160%	100%	115%	125%	160%		
3 x 6-8	SKH36L/R	--	16	2-9/16	4-3/4	1-3/8	6	16d	6	10d x 1-1/2	840	965	1050	1135	725	830	830	980		
3 x 8-12	SKH38L/R	--	16	2-9/16	6-3/4	1-3/8	10	16d	8	10d x 1-1/2	1400	1550	1550	1510	1210	1230	1230	1215		
3 x 10-14	SKH310L/R	--	16	2-9/16	8-3/4	1-3/8	14	16d	10	10d x 1-1/2	2060	2365	2465	1530	1780	2045	2090	1220		
3 x 12 - 14 - 16	SKH312L/R	--	16	2-9/16	10-3/4	1-3/8	16	16d	10	10d x 1-1/2	2350	2705	2750	1530	2035	2190	2190	1220		
2-1/2 x 9-1/4 - 14	SKH2520L/R	SUR/L2.56/9	16	2-9/16	8-5/8	1-7/8	14	10d	10	10d x 1-1/2	1650	1760	1760	1530	1380	1380	1380	1205		IBC, FL, LA
2-1/2 x 11-1/4 - 16	SKH2524L/R	SUR/L2.56/11, SUR/L2.56/14	16	2-9/16	10-3/4	1-7/8	16	10d	10	10d x 1-1/2	1890	2170	2360	1530	1635	1880	2010	1205		
2-5/8 x 9-1/4 - 14	SKH2620L/R	--	16	2-11/16	8-11/16	1-7/8	14	10d	10	10d x 1-1/2	1650	1760	1760	1530	1380	1380	1380	1205		
2-5/8 x 11-1/4 - 16	SKH2624L/R	--	16	2-11/16	10-11/16	1-7/8	16	10d	10	10d x 1-1/2	1890	2170	2360	1530	1635	1880	2010	1205		
(2) 2 x 6-8	SKH26L/R-2 *	SUR/L26-2	16	3-1/16	4-1/2	1-3/8	6	16d	6	10d	840	965	1050	1135	725	835	865	980		
	SKHH26L/R-2	HSUR/L26-2	14	3-1/16	5-1/4	2	12	16d	4	16d x 2-1/2	1850	1905	1905	795	1525	1525	1525	635		--
	SKHH26L/R-2IF	HSUR/LC26-2	14	3-1/16	5-1/4	2	12	16d	4	16d x 2-1/2										
(2) 2 x 8-12	SKH28L/R-2 *	--	16	3-1/16	6-1/2	1-3/8	10	16d	8	10d	1400	1610	1750	1350	1210	1395	1515	1060		IBC, FL, LA
(2) 2 x 10-14	SKH210L/R-2 *	SUR/L210-2	16	3-1/16	8-1/2	1-3/8	14	16d	10	10d	1960	2255	2450	1530	1695	1950	2120	1210		
	SKHH210L/R-2	HSUR/L210-2, HSUR/L214-2	14	3-1/16	8-1/2	2	20	16d	6	16d x 2-1/2	3080	3330	3330	2115	2685	2685	2685	1710		--
	SKHH210L/R-2IF	HSUR/LC210-2	14	3-1/16	8-1/2	2	20	16d	6	16d x 2-1/2										
(2) 2 x 12-16	SKH212L/R-2 *	SUR/L214-2	16	3-1/16	10-1/2	1-3/8	16	16d	10	10d	2240	2575	2800	1530	1940	2230	2405	1210		IBC, FL
3-1/2 x 8-14	SKH410L/R *	SUR/L410	14	3-9/16	8-1/2	2-1/2	16	16d	10	16d	2305	2650	2865	1530	1995	2225	2225	1190		IBC, FL, LA
3-1/2 x 12-18	SKH414L/R *	SUR/L414	14	3-9/16	12-1/2	2-1/2	22	16d	10	16d	3170	3645	3960	1530	2740	3150	3425	1190		
4 x 6-8	SKH46L/R *	SUR/L46	14	3-9/16	4-3/4	2-1/2	10	16d	6	16d	1440	1590	1590	1350	1225	1225	1225	1040		
	SKHH46L/R	HSUR/L46	14	3-9/16	5-1/4	2-1/2	12	16d	6	16d	1850	1905	1905	795	1520	1520	1520	635		--
	SKHH46L/RIF	HSUR/LC46	14	3-9/16	5-1/4	2-1/2	12	16d	6	16d										
4 x 10-14	SKH410L/R *	SUR/L410	14	3-9/16	8-1/2	2-1/2	16	16d	10	16d	2305	2650	2865	1530	1995	2225	2225	1190		IBC, FL, LA
	SKHH410L/R	HSUR/L410	14	3-9/16	8-1/2	2-1/2	20	16d	10	16d	3080	3330	3330	2115	2680	2680	2680	1705		--
	SKHH410L/RIF	HSUR/LC410	14	3-9/16	8-1/2	2-1/2	20	16d	10	16d										
4 x 14-18	SKH414L/R *	SUR/L414	14	3-9/16	12-1/2	2-1/2	22	16d	10	16d	3170	3645	3960	1530	2740	3150	3425	1190		IBC, FL, LA
	SKHH414L/R	HSUR/L414	14	3-9/16	12-1/2	2-1/2	26	16d	10	16d	4005	4115	4115	2115	3310	3310	3310	1705		--
	SKHH414L/RIF	HSUR/LC414	14	3-9/16	12-1/2	2-1/2	26	16d	10	16d										
(2) 2 - 2-1/8 x 9-1/4 - 14	SKH2020L/R-2 *	HSUR/L4.12/9, HSUR/L4.28/9	14	4-3/16	9-1/4	3-1/2	14	10d	10	10d	1710	1965	2135	1645	1480	1700	1850	1265		
(2) 2 - 2-1/8 x 11-1/4 - 18	SKH2024L/R-2 *	HSUR/L4.12/11, HSUR/L4.12/14, HSUR/L4.12/16, HSUR/L4.28/11	14	4-3/16	11-1/4	3-1/2	16	10d	10	10d	1950	2245	2440	1680	1690	1945	2110	1295		
(2) 2-5/16 x 9-1/4 - 14	SKH2320L/R-2 *	HSUR/L4.75/9	14	4-7/8	9-1/4	3-1/2	14	10d	10	10d	1710	1965	2135	1645	1480	1700	1850	1265		IBC, FL, LA
(2) 2-5/16 x 11-1/4 - 18	SKH2324L/R-2 *	HSUR/L4.75/11, HSUR/L4.75/14, HSUR/L4.75/16	14	4-7/8	11-1/4	3-1/2	16	10d	10	10d	1950	2245	2440	1680	1690	1945	2110	1295		
(2) 2-1/2 x 9-1/4 - 14	SKH2520L/R-2 *	HSUR/L5.12/9	14	5-1/8	9-1/4	3-1/2	14	10d	10	10d	1710	1965	2135	1645	1480	1700	1850	1265		
(2) 2-1/2 x 11-1/4 - 16	SKH2524L/R-2 *	HSUR/L5.12/11, HSUR/L5.12/14, HSUR/L5.12/16	14	5-1/8	11-1/4	3-1/2	16	10d	10	10d	1950	2245	2440	1680	1690	1945	2110	1295		

1) Uplift loads have been increased 60% for wind and seismic loads; no further increase shall be permitted.
 2) **NAILS:** 10d x 1-1/2 nails are 0.148" dia. x 1-1/2" long, 10d nails are 0.148" dia. x 3" long, 16d nails are 0.162" dia. x 3-1/2" long, 16d x 2-1/2 nails are 0.162" dia. x 2-1/2" long.
 *Miter cut required on the end of supported joist.

Corrosion Finish Key
■ Stainless Steel ■ Gold Coat
■ HDG ■ Triple Zinc

KF / PHG Panel Hangers

Lumber Hangers

KF – Fastens to joist ends quickly with nails

PHG – Features a gripper design to hold the joist in place with out nailing during the assembly process

Materials: 18 gauge

Finish: G90 galvanizing

Codes: IBC, FL, LA

Installation:

- Use all specified fasteners. See Product Notes, page 18.
- In panelized construction, installers are allowed to nail through both the sheathing and the hanger top flange with (1) 10d nail. The nail should be centered in the top flange and be no closer than 1/4" from the back or front edge of the top flange.
- Use locator window to center hanger on purlin center line.
- **KF / PHG – These hangers do not provide uplift resistance.**



Typical KF installation

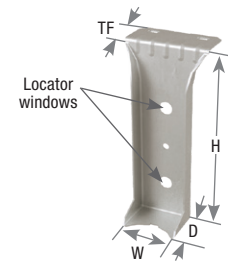

KF



Typical PHG26 installation

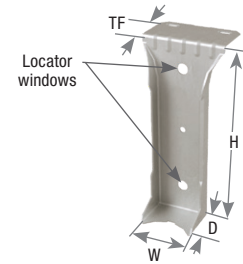

PHG26

Joist Size	MiTek Stock No.	Ref. No.	Steel Gauge	Dimensions (in)				Fastener Schedule ^{2,3}				DF/SP Allowable Loads (Lbs.) ¹	Code Ref.
				W	H	D	TF ⁵	Header		Joist			
								Qty	Type	Qty	Type	125%	
2 x 4	PHG24	HF24N	18	1-9/16	3-1/2	1-3/16	1-1/16	2	8d	--	--	580	IBC, FL, LA
2 x 6	PHG26	HF26N	18	1-9/16	5-3/8	1	1-1/16	2	10d	--	--	650	
3 x 4	PHG34	HF34N	18	2-9/16	3-1/2	1	1-1/8	2	10d	--	--	650	
3 x 6	PHG36	HF36N	18	2-9/16	5-3/8	1	1-1/8	2	10d	--	--	650	
(2) 2 x 4	PHG24-2	F24-2	18	3-1/8	3-1/2	1	1-1/8	2	10d	--	--	650	
(2) 2 x 6	PHG26-2	F26-2	18	3-1/8	5-3/8	1	1-1/8	2	10d	--	--	650	
4 x 4	KF44	--	18	3-9/16	3-3/8	1	1-1/8	2	10d	1	10d x 1-1/2	695	
4 x 6	KF46	--	18	3-9/16	5-3/8	1	1-1/8	2	10d	1	10d x 1-1/2	810	

1) Loads listed are per side.

2) **NAILS:** 8d nails are 0.131" dia. x 2-1/2" long, 10d x 1-1/2 nails are 0.148" dia. x 1-1/2" long, 10d nails are 0.148" dia. x 3" long.

JPF Purlin Hangers

Lumber Hangers

Materials: 20 gauge

Finish: G90 galvanizing

Options: See chart for Corrosion Finish Options

Codes: IBC, FL, LA

Installation:

- Use all specified fasteners. See Product Notes, page 18.
- Diamond holes allow optional header nailing.
- Joist nails must be driven at a 30° to 45° angle through the purlin into the header to achieve listed loads. **Slant/double shear nails must be used to achieve listed load values.**
- 16d sinkers (0.148" dia. x 3-1/4") may be used where 10d commons are specified with no load reduction.

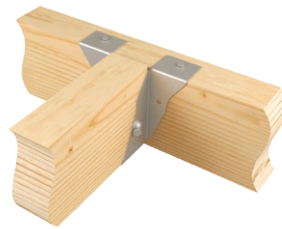

Typical JPF24 installation



Typical JPF24 back-to-back installation

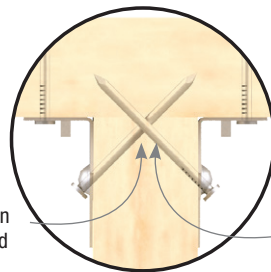

Double shear nail design features fewer nails and faster installation

Uses standard length common nails

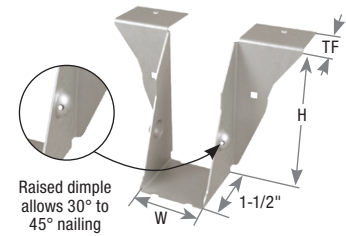

Raised dimple allows 30° to 45° nailing

JPF24

Purlin Size	MiTek Stock No.	Ref. No.	GA	Dimensions (in)			Fastener Schedule ³					DF/SP Allowable Loads (Lbs.)				S-P-F Allowable Loads (Lbs.)				Corrosion Finish	Code Ref.	
				W	H	TF	Min/Max	Header ²			Joist		Allowable Loads (Lbs.)				Allowable Loads (Lbs.)					
								Top Qty	Face Qty	Type	Qty	Type	100%	115%	125%	160%	100%	115%	125%			160%
2 x 4	JPF24	PF24	20	1-9/16	3-3/8	1-1/16	Min	2	--	10d	2	10d	1035	1035	1035	315	815	815	815	255	IBC, FL, LA	
							Max	2	2	10d	2	10d	1305	1305	1305	425	995	1040	1040	340		
2 x 6	JPF26	PF26	20	1-9/16	5-3/8	1-1/16	Min	2	--	10d	2	10d	1035	1035	1035	315	815	815	815	255	IBC, FL, LA	
							Max	2	2	10d	2	10d	1305	1305	1305	425	995	1040	1040	340		

1) Uplift loads have been increased 60% for wind and seismic loads; no further increase shall be permitted.
 2) JPF cannot be used back to back on a single ply header when optional nailing is used.
 3) **NAILS:** 10d nails are 0.148" dia. x 3" long.

Corrosion Finish Key
■ Stainless Steel ■ Gold Coat
■ HDG ■ Triple Zinc

Materials: 18 gauge
Finish: G90 galvanizing
Codes: IBC, FL, LA

Installation:

- Use all specified fasteners. See Product Notes, page 18.
- Joist nails must be driven at a 30° to 45° angle through the purlin into the header to achieve listed loads. **Slant/double shear nails must be used to achieve listed load values.**

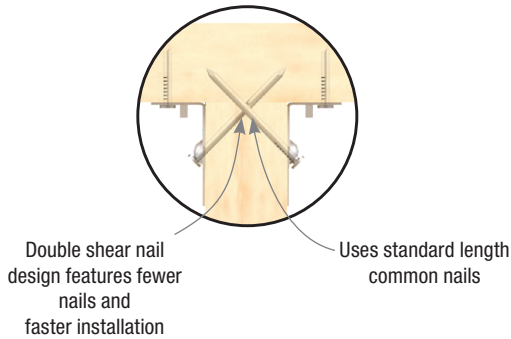
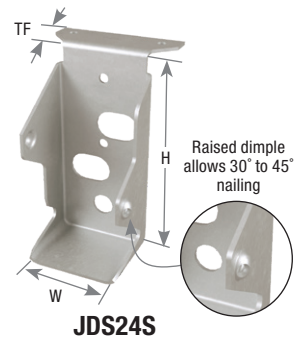
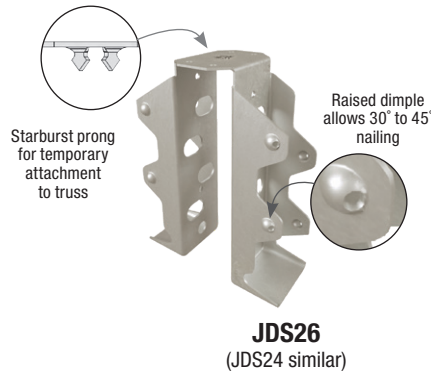

Purlin Size	MiTek Stock No.	Ref. No.	Steel Gauge	Dimensions (in)				Fastener Schedule ²						DF/SP Allowable Loads (Lbs.)				S-P-F Allowable Loads (Lbs.)				Code Ref.				
				W	H	D	TF	Header			Each Purlin			Floor		Roof		Uplift ¹		Floor			Roof		Uplift ¹	
								Min/Max	Top Qty	Face Qty	Type	Qty	Type	100%	115%	125%	160%	100%	115%	125%	160%		100%	115%	125%	160%
2 x 4 single	JDS24S	PF24B	18	1-9/16	3-1/2	1-1/4	3/4	Min	2	2	10d x 1-1/2	2	10d x 1-1/2	500	500	500	325	400	400	400	260	IBC, FL, LA				
								Max	2	--	2	2	10d	575	605	625	450	535	535	535	355					
2 x 6 single	JDS26S	PF26B	18	1-9/16	5-1/2	1-1/4	3/4	Min	2	2	10d x 1-1/2	4	10d x 1-1/2	615	615	615	420	500	500	500	340					
								Max	2	--	2	2	10d	775	830	870	745	745	745	745	585					
2 x 4 saddle	JDS24	PFD24B	18	1-9/16	3-1/2	1-1/4	1-9/16	Min	4	4	10d x 1-1/2	2	10d x 1-1/2	1000	1000	1000	370	795	795	795	325					
								Max	4	--	2	2	10d	1185	1245	1285	900	1065	1065	1065	710					
2 x 6 saddle	JDS26-175	--	18	1-9/16	5-7/16	1-1/4	1-3/4	Min	4	4	10d x 1-1/2	4	10d x 1-1/2	1235	1235	1235	740	995	995	995	655					
								Max	4	--	4	4	10d	1675	1790	1870	1490	1485	1485	1485	1170					
	JDS26	PFD26B	18	1-9/16	5-1/2	1-1/4	1-9/16	Min	4	4	10d x 1-1/2	4	10d x 1-1/2	1235	1235	1235	740	995	995	995	655					
								Max	4	--	4	4	10d	1575	1695	1775	1490	1485	1485	1485	1170					

1) Uplift loads have been increased 60% for wind and seismic loads; no further increase shall be permitted.
 2) **NAILS:** 10d x 1-1/2 nails are 0.148" dia. x 1-1/2" long, 10d nails are 0.148" dia. x 3" long.
 New products or updated product information are designated in **blue font**.

TUS / DTUS Undersaddle Hangers

Lumber Hangers

TUS – For a single-ply purlin

DTUS – For a single-ply purlin with a 2-ply saddle dimension

Materials: 20 gauge

Finish: G90 galvanizing

Patents: U.S. Patent No. 8,966,857 B2

Installation:

- Use all specified fasteners. See Product Notes, page 18.
- Attaches with standard 1-1/2" joist hanger nails that can be installed with a positive placement nail gun or be hand driven.
- Other 1-1/2" fasteners with a shear value equal or greater than a 10d nail may be used.

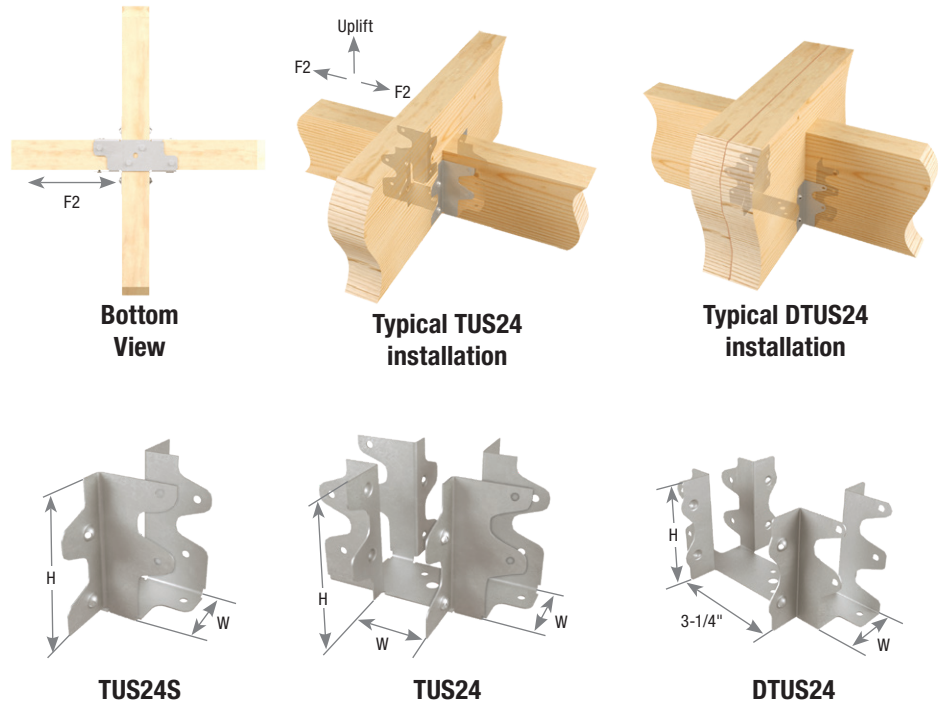

Joist Size	MiTek Stock No.	Ref. No.	Steel Gauge	Dimensions (in)		Fastener Schedule ^{2,3}						DF/SP Allowable Loads (Lbs.) ¹					Code Ref.
						Header			Joist			100%	115%	125%	Uplift ¹	F2 160%	
				W	H	Face Qty	Bottom Qty	Type	Face Qty	Bottom Qty	Type						
2 x 4 - 6 Single	TUS24S	--	20	1-9/16	3	4	1	8d x 1-1/2	4	1	8d x 1-1/2	485	550	595	505	205	
								10d x 1-1/2			10d x 1-1/2	580	620	620	505	205	
								LL915			LL915	580	620	620	505	205	
2 x 4 - 6 Saddle	TUS24	--	20	1-9/16	3	4	1	8d x 1-1/2	4	1	8d x 1-1/2	485	550	595	505	645	--
								10d x 1-1/2			10d x 1-1/2	580	620	620	505	645	
								LL915			LL915	580	620	620	505	645	
	DTUS24	--	20	1-9/16	3	4	1	8d x 1-1/2	4	1	8d x 1-1/2	485	550	595	505	645	
								10d x 1-1/2			10d x 1-1/2	580	620	620	505	645	
								LL915			LL915	580	620	620	505	645	

1) Uplift loads have been increased 60% for wind or seismic loads; no further increase shall be permitted.

2) LL915 screws are #9 (0.131" diameter) x 1-1/2" long.

3) **NAILS:** 8d x 1-1/2 nails are 0.131" dia. x 1-1/2" long, 10d x 1-1/2 nails are 0.148" dia. x 1-1/2" long, LL915 screws are #9 (0.131" dia.) x 1-1/2" long.

The FHD26 hanger straddles the header and receives a joist from both sides.

Materials: 18 gauge
Finish: G90 galvanizing

Installation:

- Use all specified fasteners. See Product Notes, page 18.
- In panelized construction, installers are allowed to nail through both the sheathing and the hanger top flange with (1) 10d nail. The nail should be centered in the top flange and be no closer than 1/4" from the back or front edge of the top flange.



Typical FHD26 installation

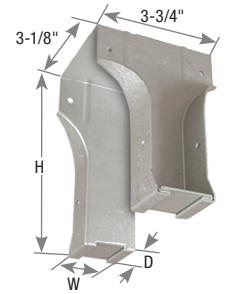

FHD26

Joist Size	MiTek Stock No.	Ref. No.	Steel Gauge	Dimensions (in)			Fastener Schedule ³						DF/SP Allowable Loads (Lbs.) ¹		Code Ref.	
				W	H	D	Header			Joist			125%	Uplift ² 160%		
							Top		Face	Qty	Type	Qty				Type
							Qty	Type	Qty							
2 x 6	FHD26	PFDS26	18	1-9/16	5-3/8	1-1/2	2	16d	2	16d	2	10d x 1-1/2	960	175	--	

1) Loads listed are per side.
 2) Uplift loads have been increased 60% for wind or seismic loads; no further increase shall be permitted.
 3) **NAILS:** 10d x 1-1/2 nails are 0.148" dia. x 1-1/2" long, 16d nails are 0.162" dia. x 3-1/2" long. 10d x 1-1/2 nails may be substituted for 16d header nails with a maximum load of 960 lbs.

CSH Concealed Stringer Hanger

The CSH-TZ concealed stringer hanger provides a method of connecting a stair stringer with a hidden hanger. The seat of the hanger is adjustable to match the slope of the stair stringer.

The reversible design allows the connector to be used on the left, right, or interior stringers. The CSH-TZ may be used with MiTek's SCA Stair Angles for a complete, easy-to-use stair framing solution.

Materials: 18 gauge
Finish: G-185 galvanizing
Codes: IBC, FL, LA
Patents: U.S. Patent No. 7,631,463

Installation:

- Use all specified fasteners. See Product Notes, page 18.
- **Bend angle only once.**

Steps:

1. Attach CSH-TZ to header with tabs positioned towards the inside of the stringer member.
2. Adjust the seat of the CSH-TZ to match the slope of the stringer member. Diamond shaped holes in the connector allow temporary installation of wood screws to aid in installation of the CSH-TZ.
3. Install 10d (0.148") x 1-1/2" HDG nails into the stringer and rim/band joist.



Typical CSH-TZ installation

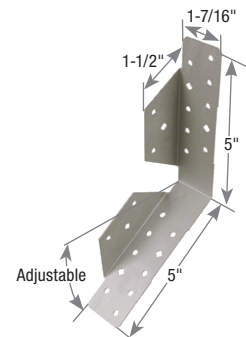

CSH-TZ

MiTek Stock No.	Ref. No.	Steel Gauge	Fastener Schedule ^{2,3}					DF/SP Allowable Loads (Lbs.)				S-P-F/Hem Fir Allowable Loads (Lbs.)				Corrosion Finish	Code Ref.
			Rim/Band Joist		Stringer			100%	115%	125%	Uplift 160%	100%	115%	125%	Uplift 160%		
			Qty	Type	Wide Face Qty	Narrow Face Qty	Type										
CSH-TZ	LSCZ	18	8	10d x 1-1/2 HDG	4	1	10d x 1-1/2 HDG	875	875	875	370	695	695	695	295	IBC, FL, LA	

1) Uplift loads are increased 60% for wind or seismic loads; no further increase shall be permitted.
 2) Stainless steel ring shank nails must be used with stainless steel connectors to achieve tabulated allowable loads.
 3) **NAILS:** 10d x 1-1/2 HDG nails are 0.148" dia. x 1-1/2" long. New products or updated product information are designated in **blue font**.

Corrosion Finish Key
 ■ Stainless Steel ■ Gold Coat
 ■ HDG ■ Triple Zinc

Deck collapses are often caused by failure of the connection where the deck is attached to the main structure due to little or no lateral capacity. ADTT-TZ is an Adjustable Deck Tension Tie designed to effectively transfer the out of plane lateral loads of the deck to the house structure.

Features:

- Adjustable design allows lag screw installation at variable distance below deck joist
- 2-hole break-out washer (BO-W) will work with multiple screw sizes
- Blocking extensions not required

Materials: 14 gauge

Finish: G-185 galvanizing

Codes: See chart for code references

Patents: U.S. Patent No. 9,809,974

Installation:

- Install with MiTek's WS8-EXT structural wood screw or 3/8" HDG lag screw. WS8-EXT or 3/8" HDG lag screws may be installed adjacent or up to 4-3/8" below deck joist (see Figure A).
- Drive screw horizontally and aligned vertically with the deck joist into the wall top plate of the main (house) structure.
- Install four (4) of the specified joist fasteners into vertical legs. (Two (2) on each side of deck joist).
- Secure front brace with six (6) specified joist fasteners.
- Re-tighten the WS8-EXT or 3/8" HDG lag screw as needed to fully engage with the ADTT-TZ. **DO NOT OVERDRIVE.** Note: Minimum 3" thread penetration required for proper installation of WS8-EXT or lag screw.
- For detailed installation instructions refer to MiTek-US.com.



Typical ADTT-TZ full extension installation
Extended Installation

Typical ADTT-TZ flush installation
Contracted Installation

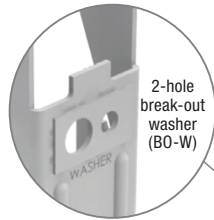

Washer Detail

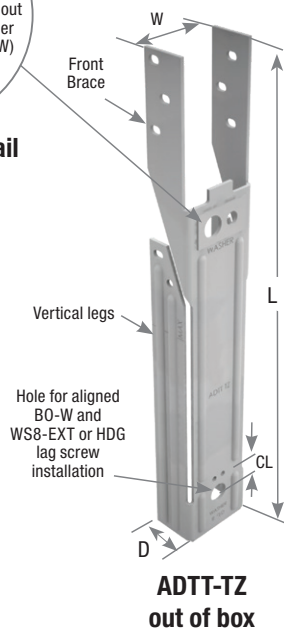

ADTT-TZ out of box

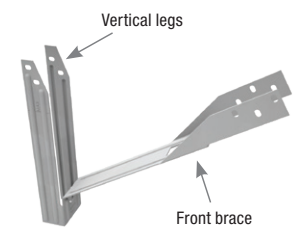

ADTT-TZ ready for installation

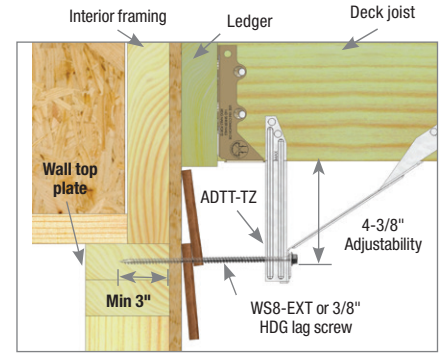

Figure A

MiTek Stock No.	Ref. No.	Steel Gauge	Dimensions (in)				Fastener Schedule				Installation Type ¹	DF/SP Allowable Tension (Lbs.)		S-P-F Allowable Tension (Lbs.)		Corrosion Finish	Code Ref.
			W	L	D	CL	Wall		Joist			160%	Δ (in) at 160% ²	160%			
							Qty	Type ^{3,4,5}	Qty	Type ^{6,8}							
ADTT-TZ	DTT1Z	14	1-9/16	10-1/2	15/16	3/8	1	3/8" HDG Lag Screw	10	10d x 1-1/2 HDG	Contracted	820	0.070	820	IBC, FL, LA		
									10	LL915	Contracted	820	0.121				
								1	WS8-EXT	10	10d x 1-1/2 HDG	Contracted	830	0.080	780	IBC, FL, LA	
										10	LL915	Contracted	830	0.121			
							1	WS8-EXT	10	LL915	Extended	790	0.114	780	--		
									10	LL915	Extended	790	0.114				
ADTT-TZKT ⁷	DTT1Z-KT	14	1-9/16	10-1/2	15/16	3/8	1	WS8-EXT	10	LL915	Contracted	830	0.121	780	--		
									10	LL915	Extended	790	0.114				

Corrosion Finish Key
■ Stainless Steel
■ Gold Coat
■ HDG
■ Triple Zinc

1) Allowable loads are for the ADTT-TZ installed tight to the bottom of the joist (Contracted) or 4" from bottom of joist to ADTT-TZ bend line (Extended).
 2) Deflections are derived from static, monotonic load tests of devices connected to DF wood members with specified fasteners.
 3) WS8-EXT is a 1/4" dia. x 8" double barrier coated screw sold by MiTek and must be ordered separately if not purchasing the kit. The minimum thread penetration into the top plate of the wall framing is 3".
 4) 3/8" HDG Lag Screw is an ASTM A307 Grade A lag screw with a thread diameter of 3/8" and is hot-dip galvanized to ASTM A153 standards. The minimum thread penetration into the top plate of the wall framing is 3". Lag screws are available at your local hardware store and must be purchased separately.

5) Check with your siding manufacturer for recommendations for fastening through your siding material.
 6) LL915 denotes a LumberLok Screw (#9 x 1-3/8" long) sold by MiTek and must be ordered separately if not purchasing the kit.
 7) ADTT-TZKT is a kit with (4) ADTT-TZ packaged with MiTek's WS8-EXT structural wood screws and LL915 LumberLok screws.
 8) **NAILS:** 10d x 1-1/2" nails are 0.148" dia. x 1-1/2" long.

Copyright © 2022 MiTek Industries, Inc. All Rights Reserved

Lumber Hangers

The DTB-TZ Deck Tie Back provides positive anchorage between the deck framing and the exterior wall with a load carrying capacity that exceeds building code requirements. When used in conjunction with MiTek's triple-zinc or gold-coat joist hangers, the DTB-TZ transfers the lateral loads into the exterior wall while the joist hangers support the vertical loads. The DTB-TZ can also be used to reinforce the connection between the rail post and the deck.

Materials: 14 gauge

Finish: G-185 galvanizing

Options: See chart for Corrosion Finish Options

Codes: IBC, FL, LA

Installation:

- Use all specified fasteners. See Product Notes, page 18.
- Install with MiTek's THR 1/2" threaded rod or equivalent.
- Drive MiTek's WS15-EXT structural wood screws into joist.
- Re-install threaded rod or anchor bolt. Secure with washer and nut.
- Tighten anchor bolt nuts finger tight to base plus 1/3 to 1/2 additional turns with wrench.



Typical DTB-TZ deck to ledger installation



Typical DTB-TZ rail post installation

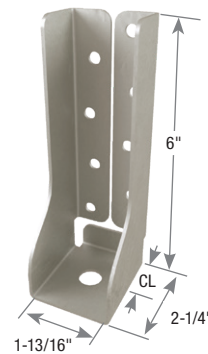

DTB-TZ

MiTek Stock No.	Ref. No.	Steel Gauge	Dimensions (in)				Fastener Schedule				Allowable Loads (Lbs.)			Corrosion Finish	Code Ref.
			W	L	D	CL	Wall		Joist		DF/SP	S-P-F	Deflection Δ (in) at 160% ²		
							Qty	Bolt ³	Qty	Screws ¹	Tension 160%	Tension 160%			
DTB-TZ	DTT2Z, FSC	14	1-13/16	6	2-1/4	1-1/8	1	1/2	8	WS15-EXT	1835	1510	0.119	Green/Blue	IBC, FL

1) MiTek's WS15-EXT structural wood screws are 1/4" dia. x 1-1/2" long and are included with DTB-TZ Deck Tie-Backs.

2) Deflections are derived from static, monotonic load tests of devices connected to DF wood members with specified fasteners.

3) Minimum ASTM A307 bolt or 1/2" threaded rod with cut washer and hex nut.

Corrosion Finish Key ■ Stainless Steel ■ Gold Coat ■ HDG ■ Triple Zinc

ERB24 – Designed to mount prefabricated fence sections and works with 2x4 horizontal section rails.

FB26 – Secures 2x6 rails to wood posts.

FRB24 – Secures continuous 2x4 rails to wood posts. Pre-punched holes allow installers to splice 2x4 rail ends within the bracket.

Materials: See chart

Finish: G-185 galvanizing

Installation:

- Use all specified fasteners. See Product Notes, page 18.



Typical ERB24-TZ installation

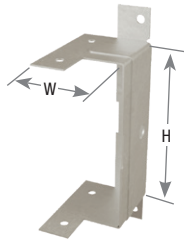

ERB24-TZ



Typical FB24-TZ installation

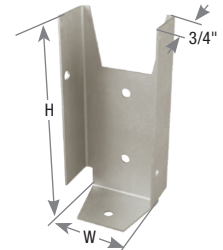

FB24-TZ



Typical FRB24-TZ installation

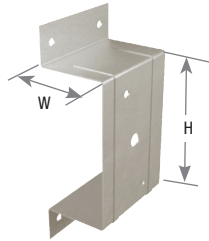

FRB24-TZ

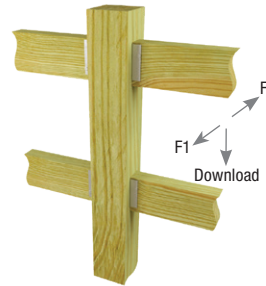

Typical FB26-TZ installation



FB26-TZ

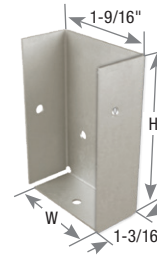

FB23-TZ



FB14-TZ

Rail Size	MiTek Stock No.	Ref. No	Steel Gauge	Dimensions (in)		Fastener Schedule ²				DF/SP Allowable Loads (Lbs) ¹				Corrosion Finish	Code Ref.
				W	H	Rail		Post		Download		F1			
						Qty	Type	Qty	Type	100%	115%	100%	115%		
1 x 4	FB14-TZ	--	18	3/4	3-1/2	3	3/4 HDG Fastener	2	8d x 1-1/2 HDG	--	--	--	--		
2 x 3	FB23-TZ	--	20	1-9/16	2-3/8	3	8d x 1-1/2 HDG	4	8d x 1-1/2 HDG	--	--	--	--		
2 x 4	ERB24-TZ	--	18	1-1/2	3-9/16	4	8d x 1-1/2 HDG	3	8d HDG	--	--	--	--		
	FB24-TZ	FB24Z, FBR24Z	20	1-9/16	3-3/8	3	8d x 1-1/2 HDG	2	8d HDG	--	--	--	--		--
	FRB24-TZ	--	18	1-9/16	3-9/16	2	10d x 1-1/2 HDG	4	10d HDG	--	--	--	--		
2 x 6	FB26-TZ	FB26	18	1-9/16	5	4	10d x 1-1/2 HDG	4	10d x 1-1/2 HDG	330	330	350	400		
						4	LL915	4	LL915	315	360	315	360		

1) Allowable loads have been increased 15% for short duration loading. No further increase is permitted.

2) **NAILS:** 8d x 1-1/2 nails are 0.131" dia. x 1-1/2" long, 8d nails are 0.131" dia. x 2-1/2" long, 10d x 1-1/2 nails are 0.148" dia. x 1-1/2" long, 10d nails are 0.148" dia. x 3" long, LL915 denotes a LumberLok screw #9 x 1-3/8" long.

New products or updated product information are designated in **blue font**.

Corrosion Finish Key ■ Stainless Steel ■ Gold Coat ■ HDG ■ Triple Zinc

A versatile solution for hanging beams from masonry walls. Face mount design allows hanger to be used with beam heights from 16" to 24". Available in a variety of widths for solid sawn, glulam, or engineered lumber beams.

Materials: 3 gauge

Finish: Primer

Codes: FL

Installation:

- Use all specified fasteners. See Product Notes, page 18.
- Fully grouted and reinforced concrete block or cast-in-place concrete with a minimum of (1) #5 rebar continuous to footing with standard hook at bolt locations.
- Minimum joist width is 3-1/2".

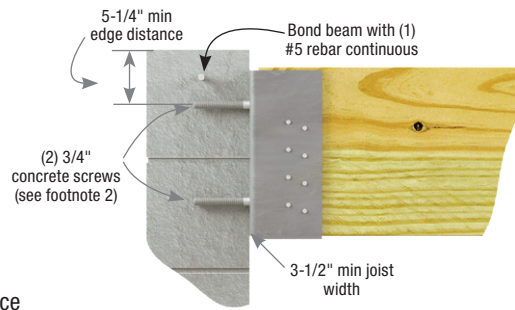

Typical UMH installation

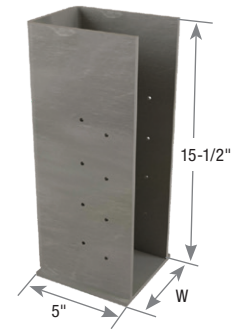

UMH

MiTek Stock No.	Ref. No.	Steel Gauge	W (in)	Fastener Schedule				DF/SP Allowable Loads (Lbs.)								Code Ref.
				Header ²		Joist ³		Masonry - 2,500 psi				Cast in Place Concrete - 3,000 psi				
				Qty	Screw Anchor	Qty	Type	Floor	Roof		Uplift ¹	Floor	Roof		Uplift ¹	
									100%	115%			125%	160%		
UMH358	MBHU3.56/16KT, MBHU3.56/18KT	3	3-5/8	2	3/4	16	16d	3550	3550	3550	3550	6380	6380	6380	4815	FL
UMH458	--	3	4-5/8	2	3/4	16	16d	3550	3550	3550	3550	6380	6380	6380	4815	
UMH538	--	3	5-3/8	2	3/4	16	16d	3550	3550	3550	3550	6380	6380	6380	4815	
UMH558	MBHU5.50/16KT, MBHU5.50/18KT	3	5-5/8	2	3/4	16	16d	3550	3550	3550	3550	6380	6380	6380	4815	
UMH718	--	3	7-1/8	2	3/4	16	16d	3550	3550	3550	3550	6380	6380	6380	4815	

1) Uplift loads have been increased 60% for wind or seismic loads; no further increase shall be permitted.
 2) Fasten UMH hanger to concrete structure with (2) 3/4" dia. DeWalt Screw-Bolt™+ screw anchors or equal with 5" minimum embedment. Screw anchors shall be installed in masonry with grouted cells in accordance with manufacturer's installation specifications.
 3) **NAILS:** 16d nails are 0.162" dia. x 3-1/2" long.

HD Masonry Face Mount Hangers

Lumber Hangers

The HD series Face Mount Hangers can be used to connect framing members, including but not limited to roof trusses, floor joists and EWP members to concrete masonry unit (CMU) and concrete walls. Allowable loads are based on extensive testing and rely on proper use of Powers® fasteners installed per manufacturer's specification.

- Masonry screws shall be Powers® Tapper+® HWH 3/16" x 1-3/4".
- Minimum 6" wide grout-filled concrete masonry units with a minimum compressive strength of 1,500 psi (10.3 MPa).
- Minimum 6" wide concrete wall with a minimum compressive strength of 2,500 psi (17.3 MPa).

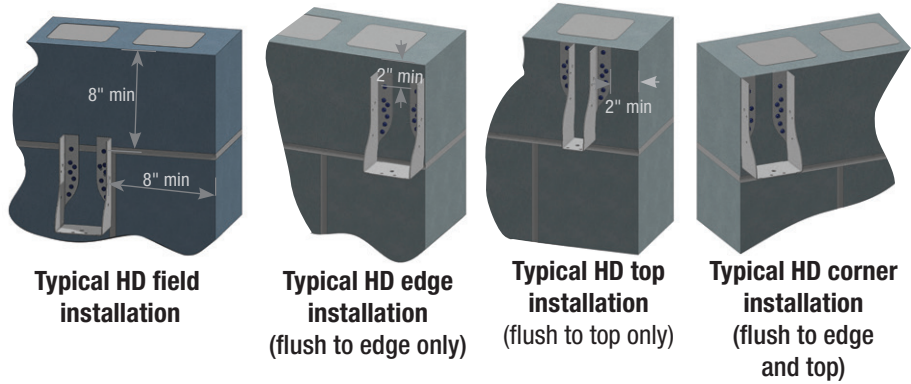

MiTek Stock No.	Ref No.	Steel Gauge	Dimensions (in)			Fastener Schedule ³				DF/SP Allowable Load (Lbs.) ^{1,2,4,5,6,7}								Code Ref.
			W	H	D	Masonry		Joist/Beam		Download (100%)				Uplift (160%)				
						Qty	Tapper+® HWH Screw Anchor	Qty	Type ⁸	Field	Edge	Top	Corner	Field	Edge	Top	Corner	
HD26	HU26	14	1-9/16	3-1/2	2-1/2	4	3/16" x 1-3/4"	4	10d x 1-1/2	1000	495	670	335	145	70	145	45	
HD28	HU28	14	1-9/16	5-1/4	2-1/2	8	3/16" x 1-3/4"	6	10d x 1-1/2	2000	990	1340	665	595	295	595	195	
HD210	HU210	14	1-9/16	7-3/16	2-1/2	14	3/16" x 1-3/4"	6	10d x 1-1/2	3110	1545	2085	1035	595	295	595	195	
HD212	--	14	1-9/16	9-13/16	2-1/2	20	3/16" x 1-3/4"	10	10d x 1-1/2	3640	1805	2440	1210	595	295	595	195	
HD26-2	HU26-2	14	3-1/8	5-1/4	2-1/2	12	3/16" x 1-3/4"	6	10d	3000	1490	2015	1000	1170	580	850	380	
HD28-2	HU28-2	14	3-1/8	7-1/8	2-1/2	14	3/16" x 1-3/4"	6	10d	3500	1735	2350	1165	1170	580	850	380	
HD210-2	HU210-2	14	3-1/8	9	2-1/2	20	3/16" x 1-3/4"	10	10d	5000	2480	3355	1665	1950	645	850	420	
HD212-2	HU212-2	14	3-1/8	11	2-1/2	24	3/16" x 1-3/4"	12	10d	5750	2850	3860	1915	2340	645	850	420	
HD44	HU44	14	3-9/16	3-5/16	2-1/2	4	3/16" x 1-3/4"	2	10d	1000	495	670	335	145	70	145	45	
HD46	HU46	14	3-9/16	5-1/16	2-1/2	12	3/16" x 1-3/4"	6	10d	3000	1490	2015	1000	1170	580	850	380	
HD48	HU48	14	3-9/16	6-15/16	2-1/2	14	3/16" x 1-3/4"	6	10d	3500	1735	2350	1165	1170	580	850	380	
HD410	HU410	14	3-9/16	8-13/16	2-1/2	20	3/16" x 1-3/4"	10	10d	5000	2480	3355	1665	1950	645	850	420	--
HD412	--	14	3-9/16	10-13/16	2-1/2	24	3/16" x 1-3/4"	12	10d	5750	2850	3860	1915	2340	645	850	420	
HD26-3	HU26-3	14	4-5/8	4-1/2	2-1/2	12	3/16" x 1-3/4"	6	10d	3000	1490	2015	1000	1170	580	850	380	
HD28-3	--	14	4-5/8	6-3/8	2-1/2	14	3/16" x 1-3/4"	6	10d	3500	1735	2350	1165	1170	580	850	380	
HD210-3	HU210-3	14	4-5/8	8-1/4	2-1/2	20	3/16" x 1-3/4"	10	10d	5000	2480	3355	1665	1950	645	850	420	
HD212-3	HU212-3	14	4-5/8	10-1/4	2-1/2	24	3/16" x 1-3/4"	12	10d	5750	2850	3860	1915	2340	645	850	420	
HD5210	--	14	5-3/8	7-7/8	2-1/2	20	3/16" x 1-3/4"	10	10d	5000	2480	3355	1665	2305	645	850	420	
HD5212	--	14	5-3/8	9-7/8	2-1/2	24	3/16" x 1-3/4"	12	10d	5750	2850	3860	1915	2765	645	850	420	
HD66	HU66	14	5-1/2	4-1/16	2-1/2	12	3/16" x 1-3/4"	6	10d	2350	1165	1575	780	1380	645	850	420	
HD68	HU68	14	5-1/2	5-15/16	2-1/2	14	3/16" x 1-3/4"	6	10d	3500	1735	2350	1165	1380	645	850	420	
HD610	HU610	14	5-1/2	7-13/16	2-1/2	20	3/16" x 1-3/4"	10	10d	5000	2480	3355	1665	2305	645	850	420	
HD612	HU612	14	5-1/2	9-13/16	2-1/2	24	3/16" x 1-3/4"	12	10d	5750	2850	3860	1915	2765	645	850	420	

- 1) Allowable loads assume the use of Powers® Tapper+® HWH 3/16" x 1-3/4".
- 2) Allowable loads assume wood members have a minimum specific gravity of 0.50 or greater.
- 3) Fasteners to be installed per manufacturer's recommendations.
- 4) Field installation indicates that the uppermost and outermost fasteners are a minimum of 8" from the top and side of the masonry wall.
- 5) Edge installation indicates that the hanger is installed flush with the edge of the masonry wall.

- 6) Top installation indicates that the hanger is installed with the hanger flush with the top of the masonry wall.
- 7) Corner installation indicates that the hanger is installed in the corner of the masonry wall flush to the edge, and the top fastener is less than 2" from the top.
- 8) **NAILS:** 10d x 1-1/2 nails are 0.148" dia. x 1-1/2 long, 10d nails are 0.148 dia. x 3" long.

Option	Skewed ^{1,3}	Sloped Seat ^{2,3}	Sloped / Skewed ^{1,2,3}	Inverted Flange ⁵
Range	1° to 67-1/2° when width is 1-3/4" or less. 1° to 50° on all others.	1° to 45°	See Sloped Seat and Skewed	2-1/4" widths or greater (Widths < 2-1/4" may be available as a Custom, contact MiTek)
Allowable Loads	100% of table load. 75% of uplift load on skews greater than 15°.	100% of table load	80% of table load. 75% of uplift load on skews greater than 15°.	100% of table load.
Ordering	Add <i>SK</i> , angle required, right (<i>R</i>) or left (<i>L</i>), and square cut (<i>SQ</i>) or bevel cut (<i>BI</i>) to product number. Example: HD410_SK45R_SQ	Add <i>SL</i> , slope required, and up (<i>U</i>) or down (<i>D</i>), to product number. Example: HD410_SL30D	See Sloped Seat and Skewed Example: HD410_SK45R_SQ_SL30D	Add <i>IF</i> , to product number. Example: HD410_IF

- 1) Skewed hangers with skews greater than 15° may have all joist nailing on outside flange.
- 2) Sloped or sloped / skewed hangers with slopes greater than 15° may have additional joist nails.
- 3) For skewed hangers, the required cut type (square or bevel) of joist member may vary based on skew angle and width of hanger. Some square cut hangers will require custom pricing due to welded back plate.
- 4) HD option hangers may be manufactured as welded products to achieve listed loads. Welded products have a primer interior finish.
- 5) Inverted flange hangers cannot be skewed when installed with masonry anchors.

LGUM / HGUM Masonry Girder Hangers

Lumber Hangers

LGUM and HGUM Masonry Girder Hangers are high-capacity beam/girder hangers designed for installation to masonry or concrete walls. The LGUM and HGUM hangers use MiTek's WS structural wood screws (supplied) to attach the beam to hanger and screw anchors (supplied) to attach to the masonry or concrete wall. These hangers eliminate the need for constructing beam pockets.

Materials: LGUM – 12 gauge; HGUM – 7 gauge

Finish: G90 galvanizing

Options: See Specialty Options chart

Installation:

- MiTek's WS3 structural wood screws and screw anchors are supplied with hangers. Substituting other fasteners may reduce capacity.
- Beams comprised of multiple plies must be adequately fastened to act as a single member.
- Beam height dimension (H) must be specified when ordering HGUM hangers.
- Moisture barrier between beam and wall may be required by local jurisdiction.

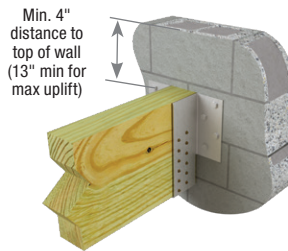
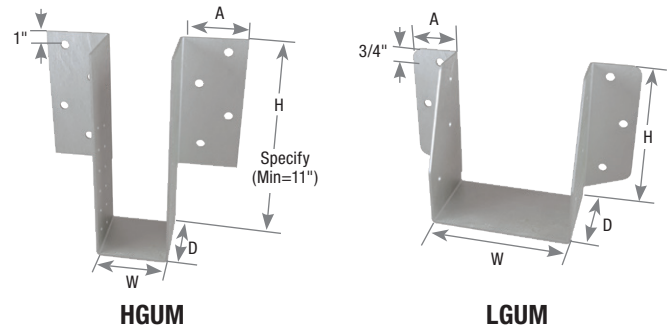

Typical HGUM installation

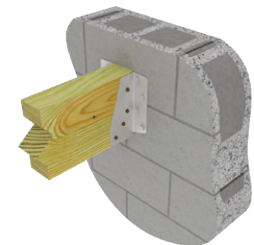

Typical LGUM installation

MiTek Stock No.	Ref. No.	Steel Gauge	Dimensions (in.)				Fastener Schedule				DF Allowable Loads (Lbs.) ²				Code Ref.
			W	H ³	D	A	CMU/Concrete		Joist		Download (100/115/125%)		Uplift (160%) ¹		
							Qty	Screw Anchor ⁴	Qty	Type ⁵	CMU 1,500psi	Concrete 2,000 psi	4" Min. to Top of Wall	13" Min. to Top of Wall	
Double 2x Sizes															
LGUM26-2	LGUM26-2-SDS	12	3-5/16	5-7/16	4	2-3/8	4	3/8" x 4"	4	WS3	6065	6425	2125	2125	
LGUM28-2	LGUM28-2-SDS			6			6				8155	8155	2770	2770	
LGUM210-2	LGUM210-2-SDS			8			8				9905	9905	3350	3350	
Triple 2x Sizes															
LGUM26-3	LGUM26-3-SDS	12	4-15/16	5-1/2	4	2-3/8	4	3/8" x 4"	4	WS3	6065	6425	2125	2125	
LGUM28-3	LGUM28-3-SDS			6			6				8155	8155	2770	2770	
LGUM210-3	LGUM210-3-SDS			8			8				9905	9905	3350	3350	
Quadruple 2x Sizes															
LGUM26-4	LGUM26-4-SDS	12	6-9/16	5-7/16	4	2-3/8	4	3/8" x 4"	4	WS3	6065	6425	2125	2125	
LGUM28-4	LGUM28-4-SDS			6			6				8155	8155	2770	2770	
LGUM210-4	LGUM210-4-SDS			8			8				9905	9905	3350	3350	
4x Sizes															
LGUM46	LGUM46-SDS	12	3-5/8	4-7/8	4	2-3/8	4	3/8" x 4"	4	WS3	6065	6425	2125	2125	
LGUM48	LGUM48-SDS			6			6				8155	8155	2770	2770	
LGUM410	LGUM410-SDS			8			8				9905	9905	3350	3350	
Engineered Wood & Structural Lumber Sizes (Heavy Duty)															
HGUM525	HGUM5.25-SDS	7	5-1/4	Specify 11 to 30	5-1/2	4-3/4	8	5/8" x 5"	24	WS3	16680	16680	4470	10130	
HGUM550	HGUM5.50-SDS		5-1/2												
HGUM700	HGUM7.00-SDS		7												
HGUM725	HGUM7.25-SDS		7-1/4												
HGUM900	HGUM9.00-SDS		9												

- 1) Uplift loads have been increased 60% for wind or seismic loads; no further increase shall be permitted.
- 2) Allowable loads assume top header fasteners are a minimum of 4" from the top of the wall.
- 3) "Specify" denotes the required supported beam height that must be specified at the time of ordering.
- 4) Use DeWalt Screw-Bolt™+ (included); or equal, installed in accordance with manufacturer's specification.
- 5) MiTek's WS3 structural wood screws are 1/4" dia. x 3" long and are included with hangers.

Specialty Options Chart – Refer to Specialty Options pages 320-321 for additional details.

Option	Inverted Flange
Range	One Inverted-Flange option available
Allowable Loads	50% of table download 75% of table uplift load
Ordering	Add /F and right (R) or left (L) to product number. Ex. HGUM525_H=18_IFL



Typical HGUM one inverted flange, left shown

MPH Masonry Hangers

Lumber Hangers

These hangers are designed to support standard lumber joists, I-Joists, or beams. Easy installation into concrete block walls makes the MPH an attractive alternative to fabricating seats in masonry (or attaching ledgers) to support joists or beams.

Materials: 12 gauge

Finish: Primer

Options: All nominal lumber sizes are available for rough full size lumber. See Specialty Options Chart on page 189.

Codes: IBC, FL, LA

Installation:

- Use all specified fasteners. See Product Notes, page 18.
- 16d duplex nails are not supplied with MPH hangers.
- Place hanger into position on top of concrete block. Install (2) 16d duplex nails (0.162" dia. x 3-1/2" double head) through the top flange nail holes. Then continue laying the next course of block.
- A minimum of one course shall be laid over hanger top flange and one course below hanger top flange. Courses adjacent to the top flange shall be subsequently grouted.
- **These products do not provide uplift resistance.**

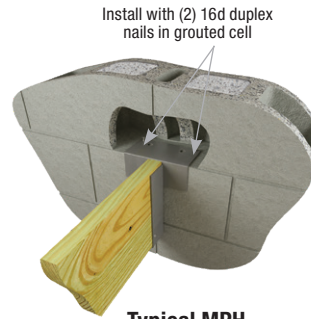

Typical MPH single-ply installation

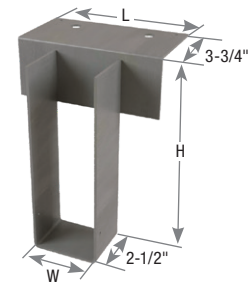

MPH

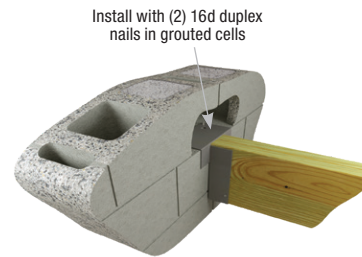

Typical MPH double-ply installation

Beam/ Joist Size	MiTek Stock No.	Ref. No.	Steel Gauge	Dimensions (in)			Fastener Schedule ²				DF/SP Allowable Loads (Lbs.) ¹			Code Ref.
				W	H	L	Block		Joist		Floor	Roof		
							Qty	Type	Qty	Type		100%	115%	
Standard Lumber Sizes														
2 x 10	MPH210	WMU1.56/9.25	12	1-9/16	9-1/4	7	2	16d duplex	2	10d x 1-1/2	2610	2650	2675	IBC, FL, LA
2 x 12	MPH212	WMU1.56/11.25	12	1-9/16	11-1/4	7	2	16d duplex	2	10d x 1-1/2	2610	2650	2675	
2 x 14	MPH214	WMU1.56/14	12	1-9/16	13-1/8	7	2	16d duplex	2	10d x 1-1/2	2610	2650	2675	
2 x 16	MPH216	WMU1.56/16	12	1-9/16	15-1/8	7	2	16d duplex	2	10d x 1-1/2	2610	2650	2675	
(2) 2 x 10	MPH210-2	WMU3.12/9.25	12	3-1/8	9-1/4	7	2	16d duplex	2	10d	4430	4430	4430	
(2) 2 x 12	MPH212-2	WMU3.12/11.25	12	3-1/8	11-1/4	7	2	16d duplex	2	10d	4430	4430	4430	
(2) 2 x 14	MPH214-2	WMU3.12/14	12	3-1/8	13-1/8	7	2	16d duplex	2	10d	4430	4430	4430	
(2) 2 x 16	MPH216-2	WMU3.12/16	12	3-1/8	15-1/8	7	2	16d duplex	2	10d	4430	4430	4430	
3 x 10	MPH310	WMU2.56/9.25	12	2-9/16	9-1/4	7	2	16d duplex	2	10d x 1-1/2	3295	3295	3295	
3 x 12	MPH312	WMU2.56/11.25	12	2-9/16	11-1/4	7	2	16d duplex	2	10d x 1-1/2	3295	3295	3295	
3 x 14	MPH314	WMU2.56/13.25	12	2-9/16	13-1/8	7	2	16d duplex	2	10d x 1-1/2	3295	3295	3295	
3 x 16	MPH316	WMU2.56/15.25	12	2-9/16	15-1/8	7	2	16d duplex	2	10d x 1-1/2	3295	3295	3295	
4 x 10	MPH410	WMU3.56/9.25	12	3-9/16	9-1/4	7	2	16d duplex	2	10d	4430	4430	4430	
4 x 12	MPH412	WMU3.56/11.25	12	3-9/16	11-1/4	7	2	16d duplex	2	10d	4430	4430	4430	
4 x 14	MPH414	WMU3.56/13.25	12	3-9/16	13-1/8	7	2	16d duplex	2	10d	4430	4430	4430	
4 x 16	MPH416	WMU3.56/15.25	12	3-9/16	15-1/8	7	2	16d duplex	2	10d	4430	4430	4430	
6 x 10	MPH610	WMU5.50/9.5	12	5-9/16	9-1/4	7	2	16d duplex	2	10d	4430	4430	4430	
Engineered Lumber Sizes														
1-1/2 x 9-1/4	MPH210	WMU1.56/9.25	12	1-9/16	9-1/4	7	2	16d duplex	2	10d x 1-1/2	2610	2650	2675	IBC, FL, LA
1-1/2 x 9-1/2	MPH1595	WMU1.56/9.5	12	1-9/16	9-1/2	7	2	16d duplex	2	10d x 1-1/2	2610	2650	2675	
1-1/2 x 11-1/4	MPH212	WMU1.56/11.25	12	1-9/16	11-1/4	7	2	16d duplex	2	10d x 1-1/2	2610	2650	2675	
1-1/2 x 11-7/8	MPH15118	WMU1.56/11.88	12	1-9/16	11-7/8	7	2	16d duplex	2	10d x 1-1/2	2610	2650	2675	
1-1/2 x 14	MPH1514	WMU1.56/14	12	1-9/16	14	7	2	16d duplex	2	10d x 1-1/2	2610	2650	2675	
1-3/4 x 9-1/2	MPH1795	WMU1.81/9.5	12	1-13/16	9-1/2	7	2	16d duplex	2	10d x 1-1/2	3000	3040	3065	
1-3/4 x 11-7/8	MPH17118	WMU1.81/11.88	12	1-13/16	11-7/8	7	2	16d duplex	2	10d x 1-1/2	3000	3040	3065	
1-3/4 x 14	MPH1714	WMU1.81/14	12	1-13/16	14	7	2	16d duplex	2	10d x 1-1/2	3000	3040	3065	
1-3/4 x 16	MPH1716	WMU1.81/16	12	1-13/16	16	7	2	16d duplex	2	10d x 1-1/2	3000	3040	3065	

1) Masonry compressive strength shall be minimum 1,500 psi.

2) **NAILS:** 10d x 1-1/2 nails are 0.148" dia. x 1-1/2" long, 10d nails are 0.148" dia. x 3" long, 16d duplex nails are 0.162" dia. x 3-1/2" long, double headed nails and shall be installed in grouted cells in accordance to manufacturer's installation specifications.

Continued on next page

Beam/ Joist Size	MiTek Stock No.	Ref. No.	Steel Gauge	Dimensions (in)			Fastener Schedule ³				DF/SP Allowable Loads (Lbs.) ¹			Code Ref.
				W	H ²	L	Block		Joist		Floor	Roof		
							Qty	Type	Qty	Type		100%	115%	
Engineered Lumber Sizes														
2-5/16 x 9-1/2	MPH2395	WMU2.37/9.5	12	2-3/8	9-1/2	7	2	16d duplex	2	10d x 1-1/2	3880	3920	3945	IBC, FL, LA
2-5/16 x 11-7/8	MPH23118	WMU2.37/11.88	12	2-3/8	11-7/8	7	2	16d duplex	2	10d x 1-1/2	3880	3920	3945	
2-5/16 x 14	MPH2314	WMU2.37/14	12	2-3/8	14	7	2	16d duplex	2	10d x 1-1/2	3880	3920	3945	
2-5/16 x 16	MPH2316	WMU2.37/16	12	2-3/8	16	7	2	16d duplex	2	10d x 1-1/2	3880	3920	3945	
2-5/16 x 18	MPH2318	WMU2.37/18	12	2-3/8	18	7	2	16d duplex	2	10d x 1-1/2	3880	3920	3945	
2-5/16 x 20	MPH2320	WMU2.37/20	12	2-3/8	20	7	2	16d duplex	2	10d x 1-1/2	3880	3920	3945	
2-1/2 x 9-1/4	MPH25925	WMU2.56/9.25	12	2-1/2	9-1/4	7	2	16d duplex	2	10d x 1-1/2	4170	4210	4240	
2-1/2 x 9-1/2	MPH2595	WMU2.56/9.5	12	2-1/2	9-1/2	7	2	16d duplex	2	10d x 1-1/2	4170	4210	4240	
2-1/2 x 11-1/4	MPH25112	WMU2.56/11.25	12	2-1/2	11-1/4	7	2	16d duplex	2	10d x 1-1/2	4170	4210	4240	
2-1/2 x 11-7/8	MPH25118	WMU2.56/11.88	12	2-1/2	11-7/8	7	2	16d duplex	2	10d x 1-1/2	4170	4210	4240	
2-1/2 x 14	MPH2514	WMU2.56/14	12	2-1/2	14	7	2	16d duplex	2	10d x 1-1/2	4170	4210	4240	
2-1/2 x 16	MPH2516	WMU2.56/16	12	2-1/2	16	7	2	16d duplex	2	10d x 1-1/2	4170	4210	4240	
2-1/2 x 18	MPH2518	WMU2.56/18	12	2-1/2	18	7	2	16d duplex	2	10d x 1-1/2	4170	4210	4240	
2-1/2 x 20	MPH2520	WMU2.56/20	12	2-1/2	20	7	2	16d duplex	2	10d x 1-1/2	4170	4210	4240	
2-1/2 x 22	MPH2522	WMU2.56/22	12	2-1/2	22	7	2	16d duplex	2	10d x 1-1/2	4170	4210	4240	
2-1/2 x 24	MPH2524	WMU2.56/24	12	2-1/2	24	7	2	16d duplex	2	10d x 1-1/2	4170	4210	4240	
2-1/2 x 26	MPH2526	WMU2.56/26	12	2-1/2	26	7	2	16d duplex	2	10d x 1-1/2	4170	4210	4240	
3 x 9-1/4	MPH210-2	WMU3.12/9.25	12	3-1/8	9-1/4	7	2	16d duplex	2	10d	4430	4430	4430	
3 x 9-1/2	MPH1595-2	WMU3.12/9.5	12	3-1/8	9-1/2	7	2	16d duplex	2	10d	4430	4430	4430	
3 x 11-1/4	MPH15112-2	WMU3.12/11.25	12	3-1/8	11-1/4	7	2	16d duplex	2	10d	4430	4430	4430	
3 x 11-7/8	MPH15118-2	WMU3.12/11.88	12	3-1/8	11-7/8	7	2	16d duplex	2	10d	4430	4430	4430	
3-1/2 x 12	MPH3512	WMU3.62/12	12	3-1/2	12	7	2	16d duplex	2	10d	4430	4430	4430	
3-1/2 x 14	MPH3514	WMU3.62/14	12	3-1/2	14	7	2	16d duplex	2	10d	4430	4430	4430	
3-1/2 x 16	MPH3516	WMU3.62/16	12	3-1/2	16	7	2	16d duplex	2	10d	4430	4430	4430	
3-1/2 x 18	MPH3518	WMU3.62/18	12	3-1/2	18	7	2	16d duplex	2	10d	4430	4430	4430	
3-1/2 x 20	MPH3520	WMU3.62/20	12	3-1/2	20	7	2	16d duplex	2	10d	4430	4430	4430	
3-1/2 x 9-1/4	MPH410	WMU3.56/9.25	12	3-9/16	9-1/4	7	2	16d duplex	2	10d	4430	4430	4430	
3-1/2 x 11-1/4	MPH412	WMU3.56/11.25	12	3-9/16	11-1/4	7	2	16d duplex	2	10d	4430	4430	4430	
3-1/2 x 9-1/2	MPH1795-2	WMU3.56/9.5	12	3-5/8	9-1/2	7	2	16d duplex	2	10d	4430	4430	4430	
3-1/2 x 11-7/8	MPH17118-2	WMU3.56/11.88	12	3-5/8	11-7/8	7	2	16d duplex	2	10d	4430	4430	4430	
4-5/8 x 11-7/8	MPH23118-2	WMU4.75/11.88	12	4-5/8	11-7/8	7	2	16d duplex	2	10d	4430	4430	4430	
4-5/8 x 14	MPH2314-2	WMU4.75/14	12	4-5/8	14	7	2	16d duplex	2	10d	4430	4430	4430	
4-5/8 x 16	MPH2316-2	WMU4.75/16	12	4-5/8	16	7	2	16d duplex	2	10d	4430	4430	4430	
4-5/8 x 18	MPH2318-2	WMU4.75/18	12	4-5/8	18	7	2	16d duplex	2	10d	4430	4430	4430	
4-5/8 x 20	MPH2320-2	WMU4.75/20	12	4-5/8	20	7	2	16d duplex	2	10d	4430	4430	4430	
5-1/4 x 9-1/2	MPH5595	WMU5.50/9.5	12	5-5/8	9-1/2	7	2	16d duplex	2	10d	4430	4430	4430	
5-1/4 x 11-7/8	MPH55118	WMU5.50/11.88	12	5-5/8	11-7/8	7	2	16d duplex	2	10d	4430	4430	4430	
7 x 9-1/2	MPH3595-2	WMU7.12/9.5	12	7-1/8	9-1/2	8	2	16d duplex	2	10d	4490	4490	4490	
7 x 11-1/4	MPH35112-2	WMU7.12/11.25	12	7-1/8	11-1/4	8	2	16d duplex	2	10d	4490	4490	4490	
7 x 11-7/8	MPH35118-2	WMU7.12/11.88	12	7-1/8	11-7/8	8	2	16d duplex	2	10d	4490	4490	4490	
7 x 14	MPH3514-2	WMU7.12/14	12	7-1/8	14	8	2	16d duplex	2	10d	4490	4490	4490	
7 x 16	MPH3516-2	WMU7.12/16	12	7-1/8	16	8	2	16d duplex	2	10d	4490	4490	4490	
7 x 18	MPH3518-2	WMU7.12/18	12	7-1/8	18	8	2	16d duplex	2	10d	4490	4490	4490	
Glulam Sizes														
3-1/8 x glulam	MPH325	WMU3.25X	12	3-1/4	specify	7	2	16d duplex	2	10d	4430	4430	4430	IBC,
5-1/8 x glulam	MPH525	WMU5.25X	12	5-1/4	specify	7	2	16d duplex	2	10d	4430	4430	4430	FL, LA

- Masonry compressive strength shall be minimum 1,500 psi.
- "Specify" denotes the required supported beam height must be specified at the time of ordering.
- NAILS:** 10d x 1-1/2 nails are 0.148" dia. x 1-1/2" long, 10d nails are 0.148" dia. x 3" long, 16d duplex nails are 0.162" dia. x 3-1/2" long, double headed nails and shall be installed in grouted cells in accordance to manufacturer's installation specifications.

Specialty Options Chart – Refer to Specialty Options pages 320, 322-323 for additional details.

Option	Skewed ^{1,3}	Sloped Seat ²	Sloped / Skewed ^{1,2,3}	Top Flange Offset	
Range	1° to 60°	1° to 45°	See Sloped Seat and Skewed	--	
Allowable Loads	100% of table load	100% of table load	100% of table load	Hanger Width 3-1/2" or less 3-9/16" to 5-1/2" 5-9/16" to 7-1/2"	% of table load: 60% 75% 85%
Ordering	Add <i>SK</i> , angle required, right (<i>R</i>) or left (<i>L</i>), and square cut (<i>SQ</i>) or bevel cut (<i>BL</i>) to product number. Ex. MPH210_SK45R_SQ	Add <i>SL</i> , slope required, and up (<i>U</i>) or down (<i>D</i>), to product number. Ex. MPH210_SL30D	See Sloped Seat and Skewed. Ex. MPH210_SK45R_SQ_SL30D	Add <i>OS</i> , and right (<i>R</i>) or left (<i>L</i>), to product number. Ex. MPH210_OSL	

- Skewed hangers with skews greater than 15° may have all joist nailing on outside flange.
- Sloped or sloped / skewed hangers with slopes greater than 15° may have additional joist nails.
- For skewed hangers, the required cut type (square or bevel) of joist member may vary based on skew angle and width of hanger. Some square cut hangers will require custom pricing due to welded back plate.

HWUH Heavy-Duty Welded Universal Hangers

Lumber Hangers

Versatile heavy-duty top flange hanger attaches to both wood and masonry. Unique design allows builders to use one style hanger on the job when the structure has a variety of support materials.

Materials: Top Flange – 3 gauge; Stirrup – 7 gauge

Finish: Primer

Options: See Specialty Options Chart on page 191

Installation:

- Use all specified fasteners. See Product Notes, page 18.
- NA21 nails are included with hangers where specified.
- **NA21 nails are not recommended for use with LVL, PSL, or LSL headers.**
- Masonry design load values apply to both solid concrete tie beams and grout-filled CMU walls.
- Alternate installation – Use (2) 1/2" x 4" DeWalt Screw-Bolt+™ or equal for loads up to 2,400 lbs. when attaching to CMU. Loads shall not exceed table loads.

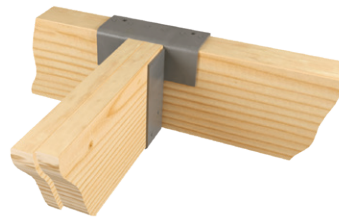

Typical HWUH410
wood-to-wood installation

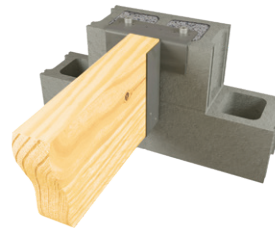

Typical HWUH410
wood-to-masonry installation

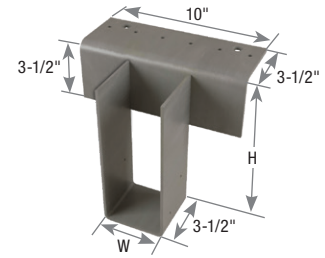

HWUH

Beam/ Joist Size	MiTek Stock No.	Ref. No.	Dimensions (in)		Installation Type	Fastener Schedule ²				DF/SP Allowable Loads (Lbs.)				Code Ref.
			W	H		Supporting Member		Supported Member		Floor	Roof	Uplift ¹	160%	
						Qty	Type	Qty	Type					
2 x 4 - 6	HWUH26	--	1-5/8	5-3/8	Wood	6	10d	4	10d x 1-1/2	3925	4020	4085	955	
					Masonry	2	1/2" x 6" J-Bolt			3060	3060	3060	1030	
2 x 8	HWUH28	--	1-5/8	7-1/8	Wood	6	10d	4	10d x 1-1/2	3925	4020	4085	955	
					Masonry	2	1/2" x 6" J-Bolt			3060	3060	3060	1030	
2 x 10	HWUH210	--	1-5/8	9-1/8	Wood	6	10d	4	10d x 1-1/2	3925	4020	4085	955	
					Masonry	2	1/2" x 6" J-Bolt			3060	3060	3060	1030	
2 x 12	HWUH212	--	1-5/8	11	Wood	6	10d	4	10d x 1-1/2	3925	4020	4085	955	
					Masonry	2	1/2" x 6" J-Bolt			3060	3060	3060	1030	
2 x 14	HWUH214	--	1-5/8	13	Wood	6	10d	4	10d x 1-1/2	3925	4020	4085	955	
					Masonry	2	1/2" x 6" J-Bolt			3060	3060	3060	1030	
2 x 16	HWUH216	--	1-5/8	16	Wood	6	10d	4	10d x 1-1/2	3925	4020	4085	955	
					Masonry	2	1/2" x 6" J-Bolt			3060	3060	3060	1030	
3 x 6	HWUH36	--	2-5/8	5-3/8	Wood	6	10d	4	10d	4615	4615	4615	955	
					Masonry	2	1/2" x 6" J-Bolt			3060	3060	3060	1030	
3 x 8	HWUH38	--	2-5/8	7-1/8	Wood	6	10d	4	10d	4615	4615	4615	955	
					Masonry	2	1/2" x 6" J-Bolt			3060	3060	3060	1030	
3 x 10	HWUH310	--	2-5/8	9-1/8	Wood	6	10d	4	10d	4615	4615	4615	955	
					Masonry	2	1/2" x 6" J-Bolt			3060	3060	3060	1030	
3 x 12	HWUH312	--	2-5/8	11	Wood	6	10d	4	10d	4615	4615	4615	955	
					Masonry	2	1/2" x 6" J-Bolt			3060	3060	3060	1030	
3 x 14	HWUH314	--	2-5/8	13	Wood	6	10d	4	10d	4615	4615	4615	955	
					Masonry	2	1/2" x 6" J-Bolt			3060	3060	3060	1030	
3 x 16	HWUH316	--	2-5/8	16	Wood	6	10d	4	10d	4615	4615	4615	955	
					Masonry	2	1/2" x 6" J-Bolt			3060	3060	3060	1030	
(2) 2 x 6	HWUH26-2	--	3-1/8	5-3/8	Wood	6	10d	4	10d	4615	4615	4615	955	
					Masonry	2	1/2" x 6" J-Bolt			3060	3060	3060	1030	
(2) 2 x 8	HWUH28-2	--	3-1/8	7-1/8	Wood	6	10d	4	10d	4615	4615	4615	955	
					Masonry	2	1/2" x 6" J-Bolt			3060	3060	3060	1030	
(2) 2 x 10	HWUH210-2	--	3-1/8	9-1/8	Wood	6	10d	4	10d	4615	4615	4615	955	
					Masonry	2	1/2" x 6" J-Bolt			3060	3060	3060	1030	
(2) 2 x 12	HWUH212-2	--	3-1/8	11	Wood	6	10d	4	10d	4615	4615	4615	955	
					Masonry	2	1/2" x 6" J-Bolt			3060	3060	3060	1030	
(2) 2 x 14	HWUH214-2	--	3-1/8	13	Wood	6	10d	4	10d	4615	4615	4615	955	
					Masonry	2	1/2" x 6" J-Bolt			3060	3060	3060	1030	
(2) 2 x 16	HWUH216-2	--	3-1/8	16	Wood	6	10d	4	10d	4615	4615	4615	955	
					Masonry	2	1/2" x 6" J-Bolt			3060	3060	3060	1030	

1) Uplift loads have been increased 60% for wind or seismic loads; no further increase shall be permitted.

2) **NAILS:** 10d nails are 0.148" dia. x 3" long.

Continued on next page

Beam/ Joist Size	MiTek Stock No.	Ref. No.	Dimensions (in)		Installation Type	Fastener Schedule ²				DF/SP Allowable Loads (Lbs.)				Code Ref.
						Supporting Member		Supported Member		Allowable Loads (Lbs.)				
			Wood			Qty	Type	Qty	Type	Allowable Loads (Lbs.)				
			100%	115%						125%	160%			
4 x 6	HWUH46	--	3-9/16	5-3/8	Wood	6	NA21	4	10d	5265	5265	5265	675	--
					Masonry	2	1/2" x 6" J-Bolt			3060	3060	3060	1030	
4 x 8	HWUH48	--	3-9/16	7-1/8	Wood	6	NA21	4	10d	5265	5265	5265	675	
					Masonry	2	1/2" x 6" J-Bolt			3060	3060	3060	1030	
4 x 10	HWUH410	--	3-9/16	9-1/8	Wood	6	NA21	4	10d	5265	5265	5265	675	
					Masonry	2	1/2" x 6" J-Bolt			3060	3060	3060	1030	
4 x 12	HWUH412	--	3-9/16	11	Wood	6	NA21	4	10d	5265	5265	5265	675	
					Masonry	2	1/2" x 6" J-Bolt			3060	3060	3060	1030	
4 x 14	HWUH414	--	3-9/16	13	Wood	6	NA21	4	10d	5265	5265	5265	675	
					Masonry	2	1/2" x 6" J-Bolt			3060	3060	3060	1030	
4 x 16	HWUH416	--	3-9/16	16	Wood	6	NA21	4	10d	5265	5265	5265	675	
					Masonry	2	1/2" x 6" J-Bolt			3060	3060	3060	1030	
6 x 6	HWUH66	--	5-1/2	5-3/8	Wood	6	NA21	4	10d	5265	5265	5265	675	
					Masonry	2	1/2" x 6" J-Bolt			3060	3060	3060	1030	
6 x 8	HWUH68	--	5-1/2	7-1/8	Wood	6	NA21	4	10d	5265	5265	5265	675	
					Masonry	2	1/2" x 6" J-Bolt			3060	3060	3060	1030	
6 x 10	HWUH610	--	5-1/2	9-1/8	Wood	6	NA21	4	10d	5265	5265	5265	675	
					Masonry	2	1/2" x 6" J-Bolt			3060	3060	3060	1030	
6 x 12	HWUH612	--	5-1/2	11	Wood	6	NA21	4	10d	5265	5265	5265	675	
					Masonry	2	1/2" x 6" J-Bolt			3060	3060	3060	1030	
6 x 14	HWUH614	--	5-1/2	13	Wood	6	NA21	4	10d	5265	5265	5265	675	
					Masonry	2	1/2" x 6" J-Bolt			3060	3060	3060	1030	
6 x 16	HWUH616	--	5-1/2	16	Wood	6	NA21	4	10d	5265	5265	5265	675	
					Masonry	2	1/2" x 6" J-Bolt			3060	3060	3060	1030	
8 x 6	HWUH86	--	7-1/2	5-3/8	Wood	6	NA21	4	10d	5265	5265	5265	675	
					Masonry	2	1/2" x 6" J-Bolt			3060	3060	3060	1030	
8 x 8	HWUH88	--	7-1/2	7-1/8	Wood	6	NA21	4	10d	5265	5265	5265	675	
					Masonry	2	1/2" x 6" J-Bolt			3060	3060	3060	1030	
8 x 10	HWUH810	--	7-1/2	9-1/8	Wood	6	NA21	4	10d	5265	5265	5265	675	
					Masonry	2	1/2" x 6" J-Bolt			3060	3060	3060	1030	
8 x 12	HWUH812	--	7-1/2	11	Wood	6	NA21	4	10d	5265	5265	5265	675	
					Masonry	2	1/2" x 6" J-Bolt			3060	3060	3060	1030	
8 x 14	HWUH814	--	7-1/2	13	Wood	6	NA21	4	10d	5265	5265	5265	675	
					Masonry	2	1/2" x 6" J-Bolt			3060	3060	3060	1030	
8 x 16	HWUH816	--	7-1/2	16	Wood	6	NA21	4	10d	5265	5265	5265	675	
					Masonry	2	1/2" x 6" J-Bolt			3060	3060	3060	1030	

1) Uplift loads have been increased 60% for wind or seismic loads; no further increase shall be permitted.
 2) **NAILS:** NA21 nails are 0.192" dia. x 1-3/4" long and are included with 4x, 6x, and 8x HWUH hangers.

Specialty Options Chart

Refer to Specialty Options pages 320, 322-323 for additional details.

Option	Skewed ^{1,3}	Sloped Seat ²	Sloped / Skewed ^{1,2,3}	Top Flange Offset		Saddle
Range	1° to 45°	1° to 45°	See Sloped Seat and Skewed	--		--
Allowable Loads	100% of table load	100% of table load	100% of table load	Hanger Width 3-1/2" or less 3-9/16" to 5-1/2" 5-9/16" to 7-1/2"	% of table load: 60% 75% 85%	100% of table load per side
Ordering	Add <i>SK</i> , angle required, right (<i>R</i>) or left (<i>L</i>), and square cut (<i>SQ</i>) or bevel cut (<i>BV</i>) to product number. Ex. HWUH410_SK45R_SQ	Add <i>SL</i> , slope required, and up (<i>U</i>) or down (<i>D</i>), to product number. Ex. HWUH410_SL30D	See Sloped Seat and Skewed. Ex. HWUH410_SK45R_SQ_SL30D	Add <i>OS</i> , and right (<i>R</i>) or left (<i>L</i>), to product number. Ex. HWUH410_OL		Add <i>SA</i> , and saddle width required to product number. Ex. HWUH410_SA=5-1/2"

1) Skewed hangers with skews greater than 15° may have all joist nailing on outside flange.
 2) Sloped or sloped / skewed hangers with slopes greater than 15° may have additional joist nails.
 3) For skewed hangers, the required cut type (square or bevel) of joist member may vary based on skew angle and width of hanger. Some square cut hangers will require custom pricing due to welded back plate.

NFM Narrow Flange Masonry Hangers

Lumber Hangers

NFM – Standard design

NFM_U – High uplift design

Materials: Top Flange – 3/8" steel; U-strap – 7 gauge

Finish: Primer

Options: See Specialty Options Chart on page 193

Codes: See chart for code references

Installation:

- Use all specified fasteners. See Product Notes, page 18.
- Designed for both concrete walls and grout-filled reinforced CMU walls.

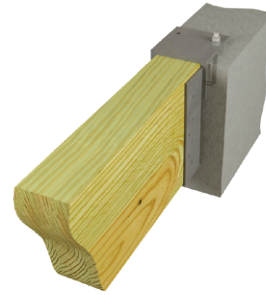

Typical NFM installation

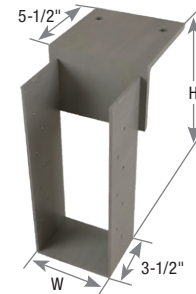

NFM3



Typical NFM_U installation



NFM3X12U

MiTek Stock No.	Ref. No.	Steel Gauge		Dimensions (in)		Fastener Schedule				DF/SP Allowable Loads (Lbs.) ^{1,2}				Code Ref.	
		Top Flange	U-Strap	W	H	Header ^{3,4,5}		Joist ⁶		Floor 100%	Roof 115%	Roof 125%	Uplift 160%		
						Qty	Type	Qty	Type						
NFM3X8	--	3/8	7	3-1/8	7-1/4	1	1/2" J-Bolt	10	10d	6720	6720	6720	1415	FL	
NFM3X10	--	3/8	7	3-1/8	9-1/4	1	1/2" J-Bolt	12	10d	6720	6720	6720	1415		
NFM3X10U	MBHA3.12/9.25	3/8	7	3-1/8	9-1/4	1	1/2" J-Bolt	5	1/2" Bolt	7130	7130	7130	2580		
NFM3X12	--	3/8	7	3-1/8	11-1/4	1	1/2" J-Bolt	14	10d	6720	6720	6720	1415		
NFM3X12U	MBHA3.12/11.25	3/8	7	3-1/8	11-1/4	1	1/2" J-Bolt	5	1/2" Bolt	7130	7130	7130	2580		
NFM3	--	3/8	7	3-3/8	11-3/4	1	1/2" J-Bolt	14	10d	7510	7510	7510	1415		
NFM35X8	--	3/8	7	3-5/8	7-1/4	1	1/2" J-Bolt	10	10d	7510	7510	7510	1415		
NFM35X8U	MBHA3.56/7.25	3/8	7	3-5/8	7-1/4	1	1/2" J-Bolt	3	1/2" Bolt	7130	7130	7130	2580		
NFM35X10	--	3/8	7	3-5/8	9-1/4	1	1/2" J-Bolt	12	10d	7510	7510	7510	1415		
NFM35X10U	MBHA3.56/9.25	3/8	7	3-5/8	9-1/4	1	1/2" J-Bolt	5	1/2" Bolt	7130	7130	7130	2580		
NFM35X12	--	3/8	7	3-5/8	11-1/4	1	1/2" J-Bolt	14	10d	7510	7510	7510	1415		
NFM35X12U	MBHA3.56/11.25	3/8	7	3-5/8	11-1/4	1	1/2" J-Bolt	5	1/2" Bolt	7130	7130	7130	2580		
NFM35X1178	--	3/8	7	3-5/8	11-7/8	1	1/2" J-Bolt	14	10d	7510	7510	7510	1415		
NFM35X1178U	MBHA3.56/11.88	3/8	7	3-5/8	11-7/8	1	1/2" J-Bolt	5	1/2" Bolt	7130	7130	7130	2580		
NFM35X14	--	3/8	7	3-5/8	14	1	1/2" J-Bolt	14	10d	7510	7510	7510	1415		FL
NFM35X14U	MBHA3.56/14	3/8	7	3-5/8	14	1	1/2" J-Bolt	5	1/2" Bolt	7130	7130	7130	2580		
NFM35X16	--	3/8	7	3-5/8	16	1	1/2" J-Bolt	14	10d	7510	7510	7510	1415		
NFM35X16U	MBHA3.56/16	3/8	7	3-5/8	16	1	1/2" J-Bolt	5	1/2" Bolt	7130	7130	7130	2580		
NFM35X18	--	3/8	7	3-5/8	18	1	1/2" J-Bolt	14	10d	7510	7510	7510	1415		
NFM35X18U	MBHA3.56/18	3/8	7	3-5/8	18	1	1/2" J-Bolt	5	1/2" Bolt	7130	7130	7130	2580		

- 1) Allowable loads are based on 2,500 psi concrete or masonry.
- 2) Design loads are governed by test ultimate loads with a safety factor of three.
- 3) J-Bolt shall be cast-in-place and have a minimum 6" embedment and not less than 4" from the edge of concrete.
- 4) In addition to the J-Bolt, "U" models also require a 3/4" dia. ITW Ramset/Redhead Dyna Bolt sleeve anchor or equal with minimum 5" embedment depth installed in the face. Bolt shall be installed in accordance with installation specifications provided by ITW Ramset.
- 5) Bolts shall conform to ASTM A 307 or better.
- 6) **NAILS:** 10d nails are 0.148" dia. x 3" long

Continued on next page

MiTek Stock No.	Ref. No.	Steel Gauge		Dimensions (in)		Fastener Schedule				DF/SP Allowable Loads (Lbs.) ^{1,2}				Code Ref.
		Top Flange	U-Strap	W	H	Header ^{3,4,5}		Joist ⁶		Floor	Roof		Uplift	
						Qty	Type	Qty	Type		100%	115%		
NFM6X8U	MBHA5.50/7.25	3/8	7	5-5/8	7-1/4	1	1/2" J-Bolt	3	1/2" Bolt	10310	10310	10310	2580	FL
NFM6X10U	MBHA5.50/9.25	3/8	7	5-5/8	9-1/4	1	1/2" J-Bolt	5	1/2" Bolt	10310	10310	10310	2580	
NFM6X12U	MBHA5.50/11.25	3/8	7	5-5/8	11-1/4	1	1/2" J-Bolt	5	1/2" Bolt	10310	10310	10310	2580	
NFM6X1178	--	3/8	7	5-5/8	11-7/8	1	1/2" J-Bolt	14	10d	7510	7510	7510	1415	
NFM6X1178U	MBHA5.50/11.88	3/8	7	5-5/8	11-7/8	1	1/2" J-Bolt	5	1/2" Bolt	10310	10310	10310	2580	
NFM6X14U	MBHA5.50/14	3/8	7	5-5/8	14	1	1/2" J-Bolt	5	1/2" Bolt	10310	10310	10310	2580	
NFM6X16	--	3/8	7	5-5/8	16	1	1/2" J-Bolt	14	10d	7510	7510	7510	1415	
NFM6X16U	MBHA5.50/16	3/8	7	5-5/8	16	1	1/2" J-Bolt	5	1/2" Bolt	10310	10310	10310	2580	
NFM6X18	--	3/8	7	5-5/8	18	1	1/2" J-Bolt	14	10d	7510	7510	7510	1415	
NFM6X18U	MBHA5.50/18	3/8	7	5-5/8	18	1	1/2" J-Bolt	5	1/2" Bolt	10310	10310	10310	2580	

- 1) Allowable loads are based on 2,500 psi concrete or masonry.
- 2) Design loads are governed by test ultimate loads with a safety factor of three.
- 3) J-Bolt shall be cast-in-place and have a minimum 6" embedment and not less than 4" from the edge of concrete.
- 4) In addition to the J-Bolt, "U" models also require a 3/4" dia. ITW Ramset/Redhead Dyna Bolt sleeve anchor or equal with minimum 5" embedment depth installed in the face. Bolt shall be installed in accordance with installation specifications provided by ITW Ramset.
- 5) Bolts shall conform to ASTM A 307 or better.
- 6) **NAILS:** 10d nails are 0.148" dia. x 3" long

Specialty Options Chart

Refer to Specialty Options pages 320, 322-323 for additional details.

Option	MiTek Series	Skewed ^{1,2}
Range	NFM / NFMU	1° to 45°
Allowable Loads	NFM / NFMU	100% of table load
Ordering	NFM	Add <i>SK</i> , angle required, right (<i>R</i>) or left (<i>L</i>), and square cut (<i>SQ</i>) or bevel cut (<i>BI</i>) to product number. Ex. NFM3_SK45R_BV
	NFMU	Add <i>SK</i> , angle required, right (<i>R</i>) or left (<i>L</i>), and square cut (<i>SQ</i>) to product number. Ex. NFM35X8U_SK45R_SQ

- 1) Skewed hangers with skews greater than 15° may have all joist nailing on outside flange.
- 2) For skewed hangers, the required cut type (square or bevel) of joist member may vary based on skew angle and width of hanger. Some square cut hangers will require custom pricing due to welded back plate.

The Fire Wall Hanger is designed for attaching truss, I-joist, solid sawn lumber, or engineered wood floor framing members to double wall top plates or minimum 2-ply 2x solid sawn header fire rated wood frame walls. The advanced design allows the installation of the FWH **before** the 5/8" gypsum wallboard (drywall) is attached and permits the building project to be completely framed-up, and weather-tight before the gypsum wallboard sheathing work starts.

Materials: 14 gauge

Finish: G90 galvanizing

Options: See Specialty Options chart on page 195

Codes: IBC, FL, LA

Patents: U.S. Patent No. 10,316,510, U.S. Patent No. 11,021,867 B2

Installation:

- Install the face of hanger flanges tight to stud wall framing.
- For typical installations, the FWH does not need to be installed at stud locations. An increase in capacity can be achieved by installing the FWH at a stud. See the Allowable Load Table on page 195.
- The end of the truss/joist should measure 1-5/8" from the face of the supporting wall. See Figure 1.
- The truss/joist should bear fully on the FWH seat with a gap no greater than 1/8" between the end of the supported member and the hanger. See Figure 1.
- **Gypsum Wallboard Installation** – Use the FWH-T template to slot cut the gypsum wallboard. See FWH-T Template Sequence. Slide the gypsum wallboard into position and fasten to the framing members meeting the minimum requirements specified by code.

Geometry Table

Joist Size (in)	MiTek Stock No.	Ref. No.	Dimensions (in)		Code Ref.
			W	H	
2 x 8	FWH28	--	1-9/16	7-1/8	
2 x 10	FWH210	--	1-9/16	9-1/8	
2 x 12	FWH212	--	1-9/16	11-1/8	
1-3/4 x 9-1/2	FWH1795	DGHF1.81/9.5	1-13/16	9-7/16	
1-3/4 x 11-7/8	FWH17118	DGHF1.81/11.88	1-13/16	11-13/16	
1-3/4 x 14	FWH1714	DGHF1.81/14	1-13/16	13-15/16	
1-3/4 x 16	FWH1716	DGHF1.81/16	1-13/16	15-15/16	
2 - 2-1/8 x 9-1/2	FWH2095	DGHF2.1/9.5	2-1/8	9-7/16	
2 - 2-1/8 x 11-7/8	FWH20118	DGHF2.1/11.88	2-1/8	11-13/16	
2 - 2-1/8 x 14	FWH2014	DGHF2.1/14	2-1/8	13-15/16	
2 - 2-1/8 x 16	FWH2016	DGHF2.1/16	2-1/8	15-15/16	
2-5/16 x 9-1/2	FWH2395	DGHF2.37/9.5	2-3/8	9-7/16	
2-5/16 x 11-7/8	FWH23118	DGHF2.37/11.88	2-3/8	11-13/16	
2-5/16 x 14	FWH2314	DGHF2.37/14	2-3/8	13-15/16	
2-5/16 x 16	FWH2316	DGHF2.37/16	2-3/8	15-15/16	
2-5/16 x 18	FWH2318	DGHF2.37/18	2-3/8	17-15/16	
2-5/16 x 20	FWH2320	DGHF2.37/20	2-3/8	19-15/16	
2-1/2 x 9-1/2	FWH2595	DGHF2.56/9.5	2-9/16	9-7/16	
2-1/2 x 11-7/8	FWH25118	DGHF2.56/11.88	2-9/16	11-13/16	
2-1/2 x 14	FWH2514	DGHF2.56/14	2-9/16	13-15/16	
2-1/2 x 16	FWH2516	DGHF2.56/16	2-9/16	15-15/16	
2-1/2 x 18	FWH2518	DGHF2.56/18	2-9/16	17-15/16	
2-1/2 x 20	FWH2520	DGHF2.56/20	2-9/16	19-15/16	
3-1/2 x 9-1/2	FWH3595	DGHF3.62/9.5	3-9/16	9-7/16	
3-1/2 x 11-7/8	FWH35118	DGHF3.62/11.88	3-9/16	11-13/16	
3-1/2 x 14	FWH3514	DGHF3.62/14	3-9/16	13-15/16	
3-1/2 x 16	FWH3516	DGHF3.62/16	3-9/16	15-15/16	
3-1/2 x 18	FWH3518	DGHF3.62/18	3-9/16	17-15/16	
3-1/2 x 20	FWH3520	DGHF3.62/20	3-9/16	19-15/16	
3-1/2 x 22	FWH3522	DGHF3.62/22	3-9/16	21-15/16	
3-1/2 x 24	FWH3524	DGHF3.62/24	3-9/16	23-15/16	

IBC,
FL,
LA

2 Hour Fire-Rating

FWH hangers are tested per ASTM E814 standards. When installed on one side of a maximum 2 hour fire-rated wall assembly, the penetration of the MiTek FWH Fire Wall Hanger through the gypsum wallboard will not reduce the fire resistive rating of the 2 hour fire resistive assembly.

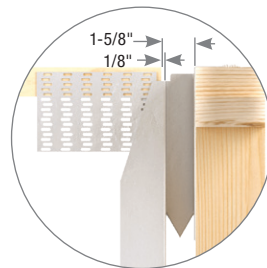
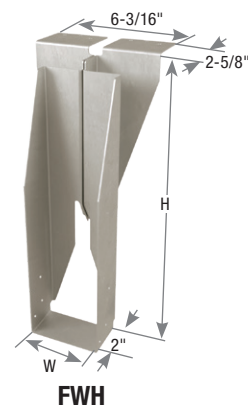
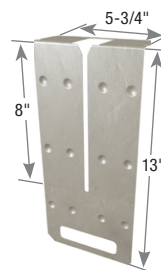

Figure 1

Typical FWH Side View



FWH



FWH-T template
(must be ordered separately)

FWH-T Template Installation Sequence

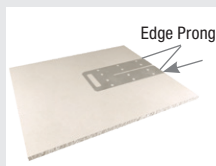

Edge Prong

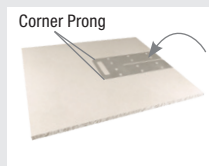

Corner Prong



- 1) Align the FWH-Template slot with the mark in the gypsum wallboard and engage the prongs into edge of gypsum wallboard
- 2) Rotate the template and press down on the end to engage the corner prongs
- 3) Run the gypsum wallboard cutter down the template to cut the slot

Copyright © 2022 MiTek Industries, Inc. All Rights Reserved

New products or updated product information are designated in **blue font**.

Continued on next page

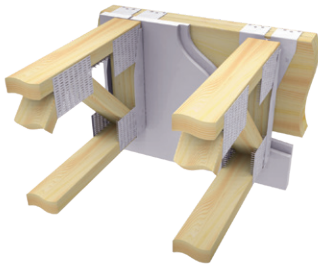

Typical FWH solid sawn header installation



Typical FWH stud wall installation

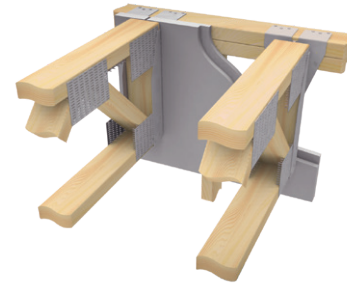

Typical FWH stud wall with (2) layers of 5/8" gypsum wallboard installation

Fastener / Allowable Load Table

Installation Type	Fastener Schedule ⁵					DF Allowable Loads (Lbs.)					
	Header			Joist		Solid Sawn Header		2-Ply, 2x Wall Top Plate		2-Ply 2x Wall Top Plate with Stud Below	
	Top Qty	Face Qty	Type	Qty	Type	Download (100/115/125%)	Uplift ¹ 160%	Download (100/115/125%)	Uplift ¹ 160%	Download ² (100/115/125%)	Uplift ¹ 160%
Without 5/8" gypsum wallboard or structural sheathing	6	--	10d	6	10d x 1-1/2	2240	180	2045	180	--	--
	6	2 4	10d	6	10d x 1-1/2	2625	380	2045	380	-- 2980³	-- 380
After (1) layer of 5/8" gypsum wallboard is installed	6	--	10d	6	10d x 1-1/2	2400	180	2400	180	--	--
	6	2 4	10d	6	10d x 1-1/2	2625	380	2400	380	-- 2980³	-- 380
After (2) layers of 5/8" gypsum wallboard are installed	6	--	10d	6	10d x 1-1/2	2400	180	2400	180	--	--
	6	2 4	10d	6	10d x 1-1/2	2625	380	2400	380	-- 2980³	-- 380
Two-sided after (2) layers of 5/8" gypsum wallboard are installed (min. 2x6 wall)	6	--	10d	6	10d x 1-1/2	2400	180	2400	180	--	--
	6	2 4	10d	6	10d x 1-1/2	2625	380	2400	380	-- 2980³	-- 380
After (1) layer of structural sheathing & (1) layer of 5/8" gypsum wallboard is installed	6	--	10d	6	10d x 1-1/2	2400	180	2400	180	--	--
	6	2 4	10d	6	10d x 1-1/2	2625	380	2400	380	-- 2980³	-- 380

- 1) Uplift Loads have been increased 60% for wind or seismic loads; no further increase shall be permitted.
- 2) Allowable downloads require at least one 2x stud at each hanger location and 4 face nails into 2-ply top plate.
- 3) FWH 1-9/16" wide hangers have an allowable download of 2,665 lb. at 100%, 2,765 lb. at 115% and 2,830 lb. at 125%.
- 4) Web stiffeners are required on I-Joist applications. Install per I-Joist manufacturer specifications.
- 5) **NAILS:** 10d x 1-1/2 nails are 0.148" dia. x 1-1/2" long, 10d nails are 0.148" dia. x 3" long. New products or updated product information are designated in **blue font**.

Nailer Options – chart represents maximum allowable loads for hangers used on wood nailers. Reference page 203

MiTek Series	Nailer Size	Fastener Schedule ⁵					DF/ SP Allowable Loads (Lbs.) ^{2,4}	
		Nailer			Joist		Download 100%	Uplift ¹ 160%
		Top Qty	Face Qty	Type	Qty	Type		
FWH	2X	6	2	10d x 1-1/2	2	10d x 1-1/2	1845	380
	3X	6	2	10d x 1-1/2	2	10d x 1-1/2	1845	380
	(2) 2X	6	4	10d	2	10d x 1-1/2	2980³	380
	4X	6	4	10d	2	10d x 1-1/2	2980³	380

- 1) Uplift loads have been increased 60% for wind or seismic loads; no further increase shall be permitted.
- 2) Listed loads shall not be increased.
- 3) FWH hangers with 1-9/16" joist width have an allowable download of 2,665 lb in DF.
- 4) Values in the table apply to standard top mount hangers without slope, skew or any other specialty options.
- 5) **NAILS:** 10d x 1-1/2 nails are 0.148" dia. x 1-1/2" long, 10d nails are 0.148" dia. x 3" long. New products or updated product information are designated in **blue font**.

Specialty Options Chart – Refer to Specialty Options pages 320 and 322 for additional details.

Option	Skewed ¹	Top Flange Offset
Range	1° to 70°	--
Allowable Loads	80% of table load on skews up to 45°. 70% of table load on skews 46° to 70°.	70% of table download. 180 lbs. Max uplift.
Ordering	Add <i>SK</i> , angle required, right (<i>R</i>) or left (<i>L</i>), and square cut (<i>SQ</i>) to product number. Ex. FWH3514_SK45R_SQ	Add <i>OS</i> , and right (<i>R</i>) or left (<i>L</i>), to product number. Ex. FWH3595_OS

1) Skewed hangers with skews greater than 15° may have all joist nailing on outside flange.

MiTek has expanded the FWH Fire Wall Hanger series to include the higher load carrying capacity FWHBP, the Fire Wall Hanger for Beams and Purlins. The FWHBP transfers the load into the supporting wall thru bearing on the top plates and directly attaching to the stud pack or post below. As with the FWH hanger, the advanced design allows you to install the hangers before the drywall is attached, allowing your project to be completely framed-up and weather-tight before the drywall sheathing shows up on site.

Materials: 12 gauge

Finish: Primer

Options: See Specialty Options chart on page 197

Codes: IBC, FL, LA

Patents: U.S. Patent No. 10,179,992

Installation:

- Install the face of hanger flanges tight to stud wall framing.
- The end of the truss/joist should measure 1-5/8" from the face of the supporting wall.
- The truss/joist should bear fully on the FWH seat with a gap no greater than 1/8" between the end of the supported member and the hanger.
- **Gypsum Wallboard Installation** – Use the FWH-T template to slot cut the gypsum wallboard. See FWH-T Template Sequence. Slide the gypsum wallboard into position and fasten to the framing members meeting the minimum requirements specified by code.

2 Hour Fire-Rating

FWH hangers are tested per ASTM E814 standards. When installed on one side of a maximum 2 hour fire-rated wall assembly, the penetration of the MiTek FWH Fire Wall Hanger through the gypsum wallboard will not reduce the fire resistive rating of the 2 hour fire resistive assembly.

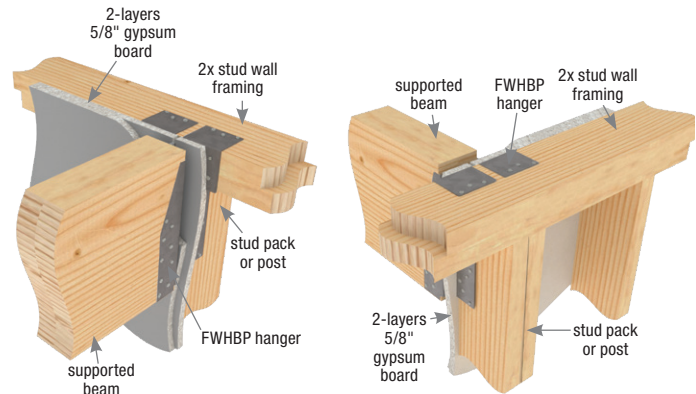

Typical FWHBP attachment to top plate/beam and stud pack/post

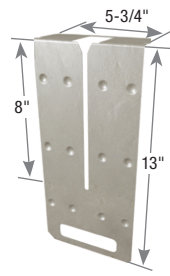

FWH-T template
(must be ordered separately)

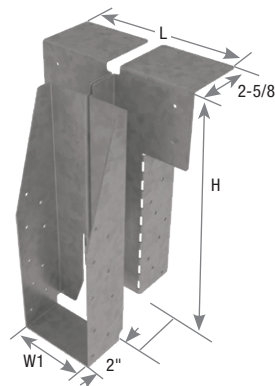

FWHBP Hanger

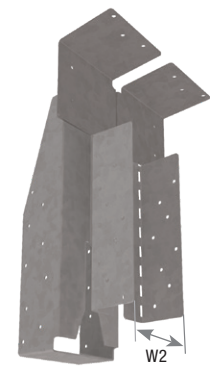

FWHBP Stud Pack Width

FWH-T Template Installation Sequence

1) Align the FWH-Template slot with the mark in the gypsum wallboard and engage the prongs into edge of gypsum wallboard

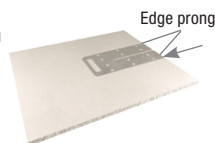

2) Rotate the template and press down on the end to engage the corner prongs

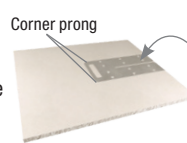

3) Run the gypsum wallboard cutter down the template to cut the slot



Copyright © 2022 MiTek Industries, Inc. All Rights Reserved

Continued on next page

Joist Size	MiTek Stock No.	Ref. No.	Steel Gauge	Dimensions (in)				Fastener Schedule ⁵					DF/SP Allowable Loads (Lbs.)				S-P-F Allowable Loads (Lbs.)				Code Ref.
				W1	W2 ³	H	L ⁴	Header			Joist Qty	Type	Download			Uplift	Download			Uplift	
								Top Qty	Face Qty	Stud Qty			2-Ply 2x Wall Top Plate ¹				2-Ply 2x Wall Top Plate ¹				
										100%	115%	125%	160% ²	100%	115%	125%	160% ²				
3-1/2 x 11-7/8	FWHBP35118	--	12	3-9/16	Specify	11-7/8	7-1/8	6	4	16	18	10d	7055	7355	7550	3045	5335	5600	5765	2410	IBC, FL, LA (W2= 3.125)
3-1/2 x 14	FWHBP3514					13-15/16															
3-1/2 x 16	FWHBP3516					15-15/16															
3-1/2 x 18	FWHBP3518					17-15/16															
3-1/2 x 20	FWHBP3520					19-15/16															
3-1/2 x 22	FWHBP3522					21-15/16															
3-1/2 x 24	FWHBP3524					23-15/16															
5-1/4 x 11-7/8	FWHBP52118	--	12	5-3/8	Specify	11-7/8	7-15/16	6	4	16	18	10d	8005	8005	8005	3045	6330	6330	6330	2410	
5-1/4 x 14	FWHBP5214					13-15/16															
5-1/4 x 16	FWHBP5216					15-15/16															
5-1/4 x 18	FWHBP5218					17-15/16															
5-1/4 x 20	FWHBP5220					19-15/16															
5-1/4 x 22	FWHBP5222					21-15/16															
5-1/4 x 24	FWHBP5224					23-15/16															
7 x 11-7/8	FWHBP71118	--	12	7-1/8	Specify	11-7/8	9-11/16	6	4	16	18	10d	5660	5660	5660	3045	4470	4470	4470	2405	
7 x 14	FWHBP7114					13-15/16															
7 x 16	FWHBP7116					15-15/16															
7 x 18	FWHBP7118					17-15/16															
7 x 20	FWHBP7120					19-15/16															
7 x 22	FWHBP7122					21-15/16															
7 x 24	FWHBP7124					23-15/16															

- 1) Download allowable load is for a 2-Ply Top Plate with stud pack (or post) below without wall and floor sheathing attached.
 - 2) Uplift loads have been increased 60% for wind or seismic loads. No further increase shall be permitted.
 - 3) "Specify" denotes required stud pack/post width must be specified when ordering. Minimum 3" for a 2-ply 2x stud pack.
 - 4) Length "L" applies where "W2" equals 3-1/8" for 2-ply stud pack. Larger "W2" widths will result in a larger length "L" and are not recognized by the code agencies.
 - 5) **NAILS:** 10d nails are 0.148" dia. x 3" long.
- New products or updated product information are designated in **blue font**.

Specialty Options Chart – Refer to Specialty Options pages 320 and 322 for additional details.

Option	Skewed ¹
Range	1° to 70°
Allowable Loads	70% of table load
Ordering	Add <i>SK</i> , angle required, right (<i>R</i>) or left (<i>L</i>), and square cut (<i>SQ</i>) to product number. Ex. FWHBP3514_SK45L_SQ

1) Skewed hangers with skews greater than 15° may have all joist nailing on outside flange.

FWHH Heavy-Duty Fire Wall Hangers

Fire Wall Hangers

The MiTek FWHH Heavy-Duty Fire Wall Hanger is designed to support beams and purlins at header locations. The higher capacity of the FWHH is achieved through top flange bearing along with added face and beam/purlin nailing. As with the FWH hanger, the advanced design allows you to install the hangers **before** the drywall is attached, allowing your project to be completely framed-up and weather-tight before the drywall sheathing shows up on site.

Materials: 12 gauge

Finish: Primer

Options: See Specialty Options chart on page 199

Codes: IBC, FL, LA

Installation:

- Install the FWHH hanger flanges tight to the face of the header.
- A minimum 2-ply 2x10 header is required for proper installation.
- The beam/purlin should bear fully on the FWHH seat with a gap no greater than 1/8" between the end of the supported member and the hanger.
- **Gypsum Wallboard Installation** - Use the FWH-T template to slot cut the gypsum wallboard. See FWH-T Template Sequence. Slide the gypsum wallboard into position and fasten to the framing members meeting the minimum requirements specified by code.

2 Hour Fire-Rating

FWH hangers are tested per ASTM E814 standards. When installed on one side of a maximum 2 hour fire-rated wall assembly, the penetration of the MiTek FWH Fire Wall Hanger through the gypsum wallboard will not reduce the fire resistive rating of the 2 hour fire resistive assembly.

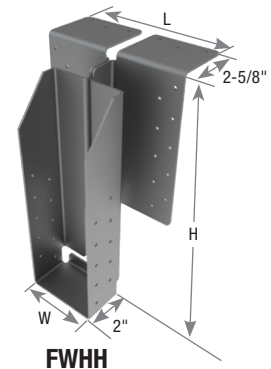

FWHH

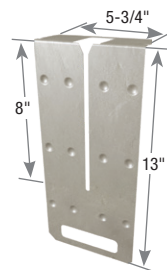

FWH-T template
(must be ordered separately)

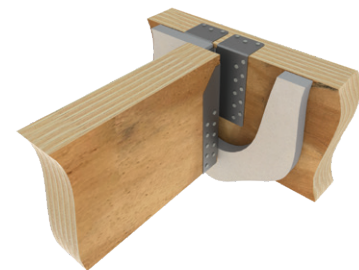

Typical FWHH installation

FWH-T Template Installation Sequence

1) Align the FWH-Template slot with the mark in the gypsum wallboard and engage the prongs into edge of gypsum wallboard

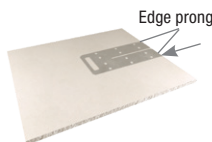

2) Rotate the template and press down on the end to engage the corner prongs

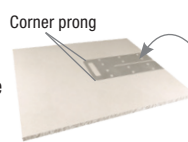

3) Run the gypsum wallboard cutter down the template to cut the slot

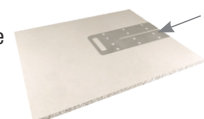

Joist Size (in)	MiTek Stock No.	Ref. No.	Steel Gauge	Dimensions (in)			Fastener Schedule ³					DF/SP Allowable Loads (Lbs.)				S-P-F Allowable Loads (Lbs.)				Code Ref.
				W	H	L	Header			Joist		Download ¹		Uplift	Download ¹			Uplift		
							Top Qty	Face Qty	Type	Qty	Type	100%	115%		125%	160% ²	100%		115%	
3-1/2 x 9-1/2	FWHH3595	--	12	3-9/16	9-7/16	7-3/16	6	20	10d	20	10d x 1-1/2	7355	7650	7650	3360	5595	5890	6075	2725	IBC, FL, LA
3-1/2 x 11-7/8	FWHH35118				11-13/16															
3-1/2 x 14	FWHH3514				13-15/16															
3-1/2 x 16	FWHH3516				15-15/16															
3-1/2 x 18	FWHH3518				17-15/16															
3-1/2 x 20	FWHH3520				19-15/16															
3-1/2 x 22	FWHH3522				21-15/16															
3-1/2 x 24	FWHH3524				23-15/16															

1) Uplift Loads have been increased 60% for wind or seismic loads; no further increase shall be permitted.

2) **NAILS:** 10d x 1-1/2 nails are 0.148" dia. x 1-1/2" long, 10d nails are 0.148" dia. x 3" long.

New products or updated product information are designated in **blue font**.

Joist Size (in)	MiTek Stock No.	Ref. No.	Steel Gauge	Dimensions (in)			Fastener Schedule ³					DF/SP Allowable Loads (Lbs.)				S-P-F Allowable Loads (Lbs.)				Code Ref.		
				W	H	L	Header		Joist			Download ¹		Uplift	Download ¹			Uplift				
							Top Qty	Face Qty	Type	Qty	Type	100%	115%		125%	160% ²	100%		115%		125%	160% ²
												100%	115%		125%	160% ²	100%		115%		125%	160% ²
5-1/4 x 9-1/4	FWHH52925	--	12	5-3/8	8-1/2	6	20	10d	20	10d x 1-1/2	7650	7650	7650	3360	6170	6170	6170	2710				
5-1/4 x 9-1/2	FWHH5295																					
5-1/4 x 11-7/8	FWHH52118																					
5-1/4 x 14	FWHH5214																					
5-1/4 x 16	FWHH5216																					
5-1/4 x 18	FWHH5218																					
5-1/4 x 20	FWHH5220																					
5-1/4 x 22	FWHH5222																					
5-1/4 x 24	FWHH5224																					
5-1/2 x 9-1/4	FWHH5925	--	12	5-9/16	8-1/2	6	20	10d	20	10d x 1-1/2	7615	7615	7615	3360	6170	6170	6170	2710	IBC, FL, LA			
5-1/2 x 9-1/2	FWHH595																					
5-1/2 x 11-7/8	FWHH55118																					
5-1/2 x 14	FWHH5514																					
5-1/2 x 16	FWHH5516																					
5-1/2 x 18	FWHH5518																					
5-1/2 x 20	FWHH5520																					
5-1/2 x 22	FWHH5522																					
5-1/2 x 24	FWHH5524																					
7 x 11-7/8	FWHH71118	--	12	7-1/8	10-1/4	6	20	10d	20	10d x 1-1/2	6005	6005	6005	3360	5825	5825	5825	2695				
7 x 14	FWHH7114																					
7 x 16	FWHH7116																					
7 x 18	FWHH7118																					
7 x 20	FWHH7120																					
7 x 22	FWHH7122																					
7 x 24	FWHH7124																					

1) Uplift Loads have been increased 60% for wind or seismic loads; no further increase shall be permitted.

2) **NAILS:** 10d x 1-1/2 nails are 0.148" dia. x 1-1/2" long, 10d nails are 0.148" dia. x 3" long.

New products or updated product information are designated in **blue font**.

Specialty Options Chart – Refer to Specialty Options pages 320 and 322 for additional details.

Option	Skewed ¹
Range	1° to 70°
Allowable Loads	70% of table load
Ordering	Add <i>SK</i> , angle required, right (<i>R</i>) or left (<i>L</i>), and square cut (<i>SQ</i>) to product number. Ex. FWHH3516_SK60R_SQ

1) Skewed hangers with skews greater than 15° may have all joist nailing on outside flange.

The FWHFM hanger fastens to the wide face of a balloon framed SCL column thereby eliminating the additive perpendicular-to-grain bearing stresses in the wall top and bottom plates seen with platform framing. The advanced design allows you to install the hangers **before** the gypsum wallboard (drywall) is attached, allowing your project to be completely framed-up and weather-tight before the gypsum wallboard sheathing shows up on site.

2 Hour Fire-Rating

FWH hangers are tested per ASTM E814 standards. When installed on one side of a maximum 2 hour fire-rated wall assembly, the penetration of the MiTek FWH Fire Wall Hanger through the gypsum wallboard will not reduce the fire resistive rating of the 2 hour fire resistive assembly.

Features and Benefits:

- Face mount hanger design installs with nails
- Attaches to the wide face of columns
- Hanger web accommodates 2-ply of 5/8" gypsum wallboard
- Achieve full table loads with or without drywall installation

Materials: 12 gauge

Finish: Primer

Options: See Specialty Options chart on page 201

Codes: IBC, FL, LA

Patents: Pending

Installation:

- Install the face of hanger flanges tight to SCL column/framing.
- The end of the truss/joist should measure 1-5/8" from the face of the supporting column.
- The truss/joist should bear fully on the FWH seat with a gap no greater than 1/8" between the end of the supported member and the hanger.
- **Gypsum Wallboard Installation** – Use the FWH-T template to slot cut the gypsum wallboard. See FWH-T Template Sequence. Slide the gypsum wallboard into position and fasten to the framing members meeting the minimum requirements specified by code.

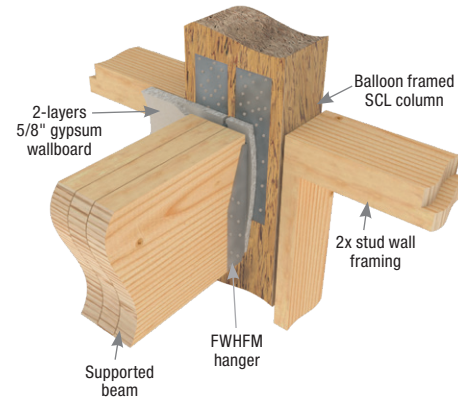

Typical FWHFM installation

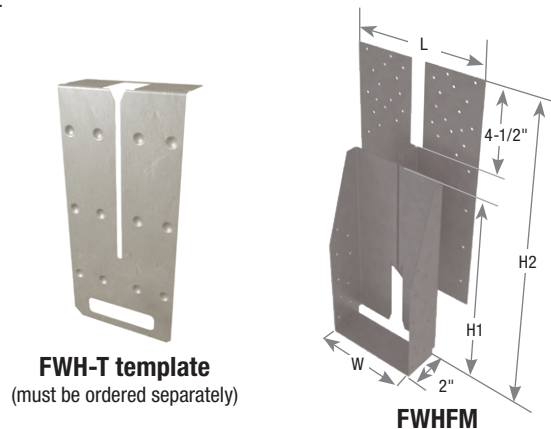

FWH-T template
(must be ordered separately)

FWHFM

FWH-T Template Installation Sequence

1) Align the FWH-Template slot with the mark in the gypsum wallboard and engage the prongs into edge of gypsum wallboard

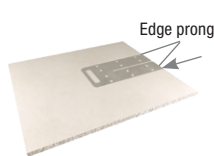

2) Rotate the template and press down on the end to engage the corner prongs

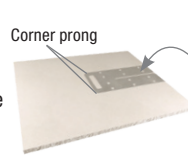

3) Run the gypsum wallboard cutter down the template to cut the slot



Joist Size (in)	MiTek Stock No.	Ref. No.	Steel Gauge	Dimensions (in)				Fastener Schedule ⁴				DF/SP Allowable Loads (Lbs.)				S-P-F Allowable Loads (Lbs.)				Code Ref.
				W	H1	H2	L	Header		Joist		Download ¹		Uplift ²	Download ¹		Uplift ²			
								Face Qty	Type	Qty	Type	100%	115%		125%	160% ²		100%	115%	
														100%			115%			
3-1/2 x 9-1/4	FWHFM35925				9-1/16	13-9/16														
3-1/2 x 9-1/2	FWHFM3595				9-5/16	13-13/16														
3-1/2 x 11-7/8	FWHFM35118				11-11/16	16-3/16														
3-1/2 x 14	FWHFM3514				13-13/16	18-5/16														
3-1/2 x 16	FWHFM3516	--	12	3-9/16	15-13/16	20-5/16	4-11/16	40	10d	18	10d x 1-1/2	5960	6625	7050	2820	5245	5600	5765	2290	
3-1/2 x 18	FWHFM3518				17-13/16	22-5/16														
3-1/2 x 20	FWHFM3520				19-13/16	24-5/16														
3-1/2 x 22	FWHFM3522				21-13/16	26-5/16														
3-1/2 x 24	FWHFM3524				23-13/16	28-5/16														
4 - 4-3/16 x 9-1/4	FWHFM42925				9-1/16	13-9/16														
4 - 4-3/16 x 9-1/2	FWHFM4295				9-5/16	13-13/16														
4 - 4-3/16 x 11-7/8	FWHFM42118				11-7/16	15-15/16														
4 - 4-3/16 x 14	FWHFM4214				13-5/8	18-1/8														
4 - 4-3/16 x 16	FWHFM4216	--	12	4-3/16	15-5/8	20-1/8	5-5/16	40	10d	18	10d x 1-1/2	5960	6625	7050	2820	5245	5830	6205	2280	
4 - 4-3/16 x 18	FWHFM4218				17-5/8	22-1/8														
4 - 4-3/16 x 20	FWHFM4220				19-5/8	24-1/8														
4 - 4-3/16 x 22	FWHFM4222				21-5/8	26-1/8														
4 - 4-3/16 x 24	FWHFM4224				23-5/8	28-1/8														
5-1/4 x 9-1/4	FWHFM52925				9-1/16	13-9/16														
5-1/4 x 9-1/2	FWHFM5295				9-5/16	13-13/16														
5-1/4 x 11-7/8	FWHFM52118				11-5/8	16-1/8														
5-1/4 x 14	FWHFM5214				13-13/16	18-5/16														
5-1/4 x 16	FWHFM5216	--	12	5-3/8	15-13/16	20-5/16	6-1/2	40	10d	18	10d x 1-1/2	5960	6625	7050	2820	5245	5830	6205	2270	
5-1/4 x 18	FWHFM5218				17-13/16	22-5/16														
5-1/4 x 20	FWHFM5220				19-23/28	24-5/16														
5-1/4 x 22	FWHFM5222				21-13/16	26-5/16														
5-1/4 x 24	FWHFM5224				23-13/16	28-5/16														
7 x 11-7/8	FWHFM71118				11-11/16	16-3/16														
7 x 14	FWHFM7114				13-13/16	18-5/16														
7 x 16	FWHFM7116				15-13/16	20-5/16														
7 x 18	FWHFM7118	--	12	7-1/8	17-13/16	22-5/16	8-1/4	40	10d	18	10d x 1-1/2	5960	6085	6085	2820	5245	5605	5605	2260	
7 x 20	FWHFM7120				19-13/16	24-5/16														
7 x 22	FWHFM7122				21-13/16	26-5/16														
7 x 24	FWHFM7124				23-13/16	28-5/16														

IBC, FL, LA

- 1) Download allowable load is for attachment to the wide face of a supporting column.
 - 2) Uplift loads have been increased 60% for wind or seismic loads. No further increase shall be permitted.
 - 3) Distance from the supported member to the edge of the header support flange is 9/16".
 - 4) **NAILS:** 10d x 1-1/2 nails are 0.148" dia. x 1-1/2" long, 10d nails are 0.148" dia. x 3" long.
- New products or updated product information are designated in **blue font**.

Specialty Options Chart – Refer to Specialty Options pages 320-321 for additional details.

Option	Skewed ¹
Range	1° to 70°
Allowable Loads	70% of table load
Ordering	Add <i>SK</i> , angle required, right (<i>R</i>) or left (<i>L</i>), and square cut (<i>SQ</i>) to product number. Ex. FWHFM5214_SK60L_SQ

- 1) Skewed hangers with skews greater than 15° may have all joist nailing on outside flange.

Sloped I-Joists

Use sloped seat hangers and beveled web stiffeners whenever the slope exceeds the following: 1/2:12 for seat bearing lengths of 2-1/2" or less; 3/8:12 for bearing lengths between 2-1/2" and 3-1/2"; and 1/4:12 for bearing lengths in excess of 3-1/2".

Multiple I-Joist Plies

Fasten together multiple plies of wood I-Joists, in accordance with the manufacturer's installation guidelines, such that the joists act as a single unit.

I-Joist Rotation

It may be necessary to install straps, blocking, or sheathing to restrain torsional rotation of a supporting wood I-Joist when using top mount I-Joist hangers.

Fasteners

Install only the specified nails. The flanges of wood I-Joists may split if larger diameter nails or longer nails are installed. Do not install nails larger than 16d common wire nails (0.162" diameter) into the web stiffeners in the wood I-Joist.

Backer Blocks

Pattern the nails used to install backer blocks or web stiffeners in wood I-Joists to avoid splitting the block. The nail pattern should be sufficiently spaced to avoid the same grain line, particularly with solid sawn backer blocks. Backer blocks must be installed on wood I-Joist acting as the header, or supporting member. Install in accordance with the I-Joist manufacturer's installation guidelines. The nails used to install hangers mounted to an I-Joist header must penetrate through the web and into the backer block on the opposite side.

Top Flange Hangers

The thickness of the hanger metal and nail heads on top mount hangers must be evaluated for the effect on subsequent sheathing. Ensure that the top mount hanger is installed so the flanges of the hanger are not over-spread which tends to elevate the supported I-Joist causing uneven

floor surfaces and squeaking. Similarly, ensure that the hanger is installed plumb such that the face flanges of the hanger are mounted firmly against the wide-face surface of the header.



Flush framing

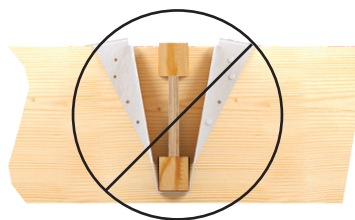

⚠ Hanger over-spread

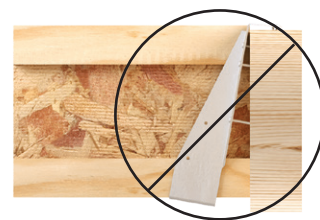

⚠ Hanger not plumb

Correct Slant Nail Installation



Always secure wood I-Joist using 10d x 1-1/2" nail driven at a 30° to 45° angle and firmly seated



Common Nailing Errors

⚠ Wrong Angle

When a nail is driven into the bottom flange of the wood I-Joist parallel to the glue lines, separation of veneers can occur which substantially reduces the design loads of the connection.



⚠ Nail Too Long

When using nails longer than MiTek's recommended nails, bottom flange splitting may occur. Also, this can raise the wood I-Joist off the seat, resulting in uneven surfaces and squeaky floors along with reduced allowable loads.

Hangers for joists **without web stiffeners** must support the I-Joist's top flange and provide lateral resistance with no less than 1/8" contact.

be 60% of the joist height for stability during construction. If this cannot be accomplished, potential joist rotation must be resolved by other means.

MiTTek recommends that hangers for joist **with web stiffeners** should

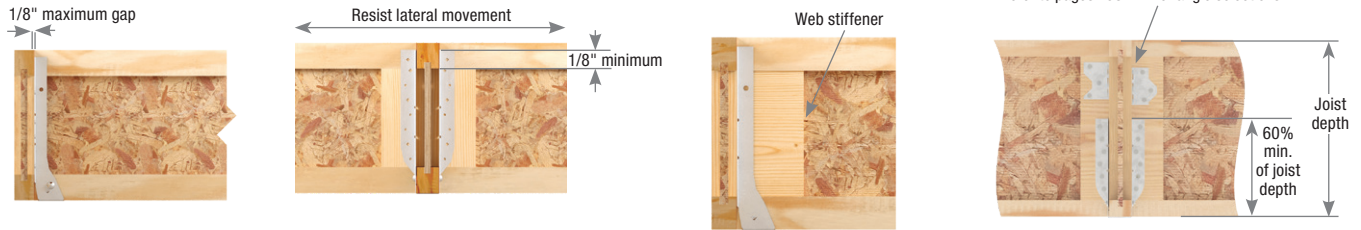

(Top flange support requirements can be verified in this section charts under Web stiffener Req'd. column.)

Nailer Installations

Correct Hanger Attachment to Nailer

A nailer or sill plate is considered to be any wood member attached to a steel beam, concrete block wall, concrete stem wall, or other structure unsuitable for nailing, which is used as a nailing surface for top mount hangers to hold beams or joists.

Nailer Sized Correctly

Top flange of hanger is fully supported and recommended nails have full penetration into nailer, resulting in a carried member hanging safely at the proper height.

The nailer must be sized to fit the support width as shown and be of sufficient thickness to satisfy recommended top flange nailing requirements. A design professional must specify nailer attachment to steel beams.

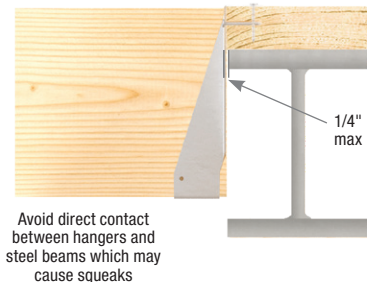

Correct Attachment

Wrong Nailer Size Causes Component Failure

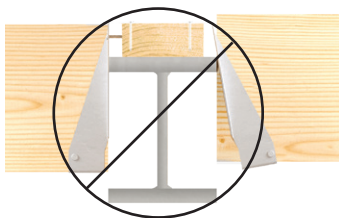

Too Narrow

Top flange not fully supported can cause nail breakout. Or, by fully supporting top flange, hanger is tilted back, causing lifting of carried member which results in uneven surfaces and squeaky floors.

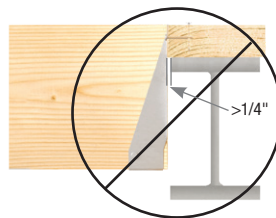

Too Wide

Loading can cause cross grain breaking of nailer. The recommended nailer overhang is 1/4" maximum per side.



Too Thin

Top flange nailing cannot fully penetrate nailer, causing reduced allowable loads. Never use hangers which require multiple face nails since the allowable loads are dependent on all nail holes being used.

Hanger Type	MiTek Series	Steel Gauge	Supporting Member										Supported Member					Allowable Loads (Lbs.) Range		MiTek Series Product Catalog Page Reference
			Beam/Joist/Rafter (rect shapes)	I-Joist	Truss (2x)	Floor Truss 4x	Nailer	Glulam	Wall	Post	Rim Joist	Beam/Joist/Rafter (rect shapes)	I-Joist	Truss (2x)	Floor Truss 4x	Glulam	Stringer	Header Material		
																		LVL 100%	DF/SP 100%	
Face Mount	THF	16 or 12	•	•			•				•	•	•	•			1,890 - 3,190	1,890 - 3,190	207, 213	
	THFI	18	•	•			•				•	•	•	•			960 - 1,680	960 - 1,680	205, 212	
	IHFL	18	•	•	•		•		•		•			•			960 - 1,920	960 - 1,920	206, 211-213	
	IHF	16	•	•	•		•				•			•			1,000 - 4,410	1,000 - 4,410	206, 211-213	
	HUS	16	•		•		•			•	•		•	•			2,760 - 5,580	2,760 - 5,580	209, 214	
	HD	14	•		•		•			•	•	•	•	•	•		1,850 - 4,620	1,850 - 4,620	208, 213-216	
	HDQIF	14	•		•		•		•	•	•	•	•	•	•		3,340 - 5,605	3,340 - 5,605	209, 214-216	
	THD	14 or 12	•		•		•			•	•	•	•	•	•		5,850 - 8,285	5,850 - 8,285	210, 215-216	
	THDH	12	•		•		•			•	•	•	•	•	•		9,020 - 11,325	9,020 - 11,325	210, 214-216	
Top Mount	TFL	18	•	•		•	•	•			•	•	•	•			1,585	1,585	217, 221-222	
	THO	18, 16 or 12	•	•		•	•	•			•	•	•	•			1,235 - 5,660	1,235 - 5,000	217, 221-226	
	TFI	16	•	•		•	•	•			•	•	•	•			2,715 - 2,820	2,715 - 2,820	217, 222, 224-225	
	BPH	12	•		•	•	•	•	•	•	•	•	•	•			2,830 - 3,100	2,825 - 3,100	218, 221, 223-229	
	HBPH	10	•		•	•	•	•		•	•	•	•	•			6,185 - 6,310	6,185 - 6,310	218, 223-229	
	PHM	7 - Top Flange; 10 - Stirrup	•			•	•	•			•	•	•	•			3,265 - 3,390	3,060 - 3,390	220-229	
	PHXU	7	•			•	•	•			•	•	•	•			4,350 - 5,910	4,350 - 5,910	220-221, 223-225, 227-229	
	HLBH	7	•				•				•	•	•	•			10,045	10,045	219, 223-225, 227-229	
Glulam	GHF	12 or 7	•				•				•			•			2,740 - 13,000	2,740 - 13,000	233-234	
	HGU	7	•		•		•				•	•	•	•			14,705	14,705	232	
	KLEG ¹	7	•				•				•			•			11,980	11,980	235	
	KMEG ¹	7	•				•				•			•			12,635	12,635	235	
	KEG ¹	1/4" - Top Flange; 7 - Stirrup	•				•				•			•			17,615 - 21,145	17,615 - 21,145	235	
	KEGQ	3 - Top Flange; 7 - U-Strap	•				•				•			•			17,265	17,265	234	
	KHHB	7	•				•				•			•			6,480	6,480	236	
	KGB	7	•				•				•	•		•			6,480	6,480	236	
	KHGB	7	•				•				•	•		•			6,480	6,480	236	
	KGLT	3 - Top Flange; 7 - Stirrup	•				•	•			•			•			10,555	10,555	237-238	
	KHGLT	3 - Top Flange; 7 - Stirrup	•				•				•			•			12,495	12,495	237-238	
	KGLS	3 - Top Flange; 7 - Stirrup	•				•				•	•		•			11,070 - 21,220	11,070 - 21,220	238-239	
	KHGLS	3 - Top Flange; 7 - Stirrup	•				•				•			•			21,750 - 23,195	21,750 - 23,195	238-239	
	KGLST	3 - Top Flange; 7 - Stirrup	•				•				•	•		•			13,695 - 26,890	13,695 - 26,890	238-239	
	KHGLST	3 - Top Flange; 7 - Stirrup	•				•				•			•			20,315 - 28,975	20,315 - 28,975	238-239	
LGU	10	•		•		•				•	•	•	•			7,135	7,135	232		
MGU	10	•				•				•	•	•	•			9,515	9,515	232		
Slope / Skew	LSSH	18 or 16	•	•	•		•				•	•	•	•	•		620 - 2,645	620 - 2,645	231	

1) KEG, KLEG, KMEG hangers assume allowable loads with top flange.

2) When an I-Joist is used as a header, designer must evaluate if a web stiffener or backer block is required.

• Represents common applications and product configurations. Consult MiTek for additional applications and/or optional product configurations.

The THFI is a face mount hanger designed to attach EWP I-joist members to wood headers. The unique design of the THFI combines the installation ease of a top mount hanger with the installation flexibility of a face mount hanger. Because the side flanges extend to the top chord of the I-joist, web stiffeners are not required. The THFI hangers also feature strategically placed Seat Cleats® which lock the bottom flange of the I-joist to the hanger eliminating the need for joist nails to be installed.

The innovative top flange alignment tabs with the holding cleats assist the placing and alignment of the hanger prior to nailing by hanging onto the header with holding cleats biting into the wood. If the alignment tabs are not desired or a deeper height member is to be carried, the tabs can be easily bent out of the way. Alignment tabs do not contribute to the allowable design values of the THFI hangers.

Materials: 18 Gauge

Finish: G90 galvanizing

Codes: IBC, FL, LA

Patents: U.S. Patent No. 5,564,248 & U.S. Patent No. 9,206,594 B1

Installation:

- Use all specified fasteners.
- Alignment tabs are not structural and can be bent back or removed to assist hanger placement.
- Web stiffeners are not required for THFI hangers unless specified by the I-joist manufacturer. Web stiffeners are not required for lateral stability.
- For additional uplift capacity, install (2) 10d x 1-1/2" nails through diamond holes and into the joist member. (web stiffeners required)
- THFI2514 model has diamond holes in the header flange for Min/Max nailing option. For the Max nailing option, install nails in both the round and diamond shaped header holes.

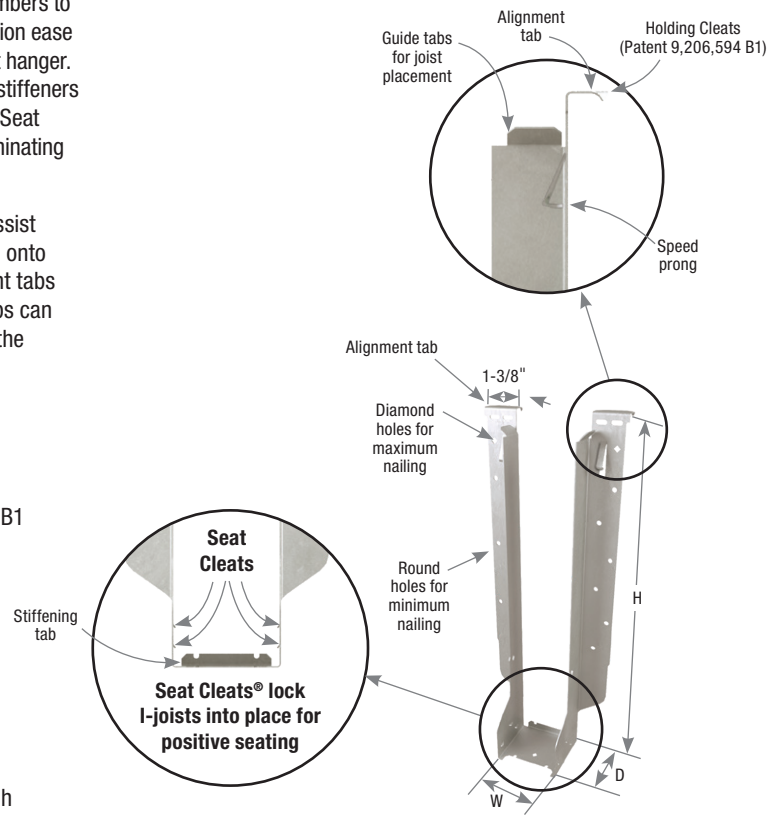

THFI2514



Typical THFI installation

IHFL (18GA) and IHF (16GA) series face mount hangers feature speed prongs for temporary placement and seat cleats to grab the bottom flange of the supported I-joist. Diamond holes in header and joist allow for optional Max nailing for customized fastening to match allowable load needed. Install nails in all fastener holes when the Max allowable load is needed while lighter load capacities can be achieved with a quick installation of round holes only, saving you time and money on the jobsite.

Features:

- Seat Cleats lock bottom chord of I-joist eliminating need for joist nails.
- Dimples with diamond nail holes for optional joist nailing when higher uplift loads are needed.
- Min/Max nailing provide flexible installation options.

Materials: IHFL – 18 gauge; IHF – 16 gauge

Finish: G90 galvanizing

Options: See Specialty Options chart

Codes: IBC, FL, LA

Patents: U.S. Patent No. #5,564,248

Installation:

- Use all specified fasteners.
- Position I-joist into hangers and tap or push into place to fully seat joist and engage cleats.
- Web stiffeners are not required unless specified by the I-joist manufacturer.
- **Min Nailing** – Fill all round nail holes.
- **Max Nailing** – Fill all round and diamond holes.

Uplift Capacity Options:

- **IHFL (18GA)** – For additional uplift capacity, install (2) 10d (0.148") x 1-1/2" nails through diamond dimple holes into the bottom chord of I-joist member for a total uplift of 220 lbs.
- **IHF (16GA)** – Uplift capacity for hangers installed without joist nails is 65 lbs.

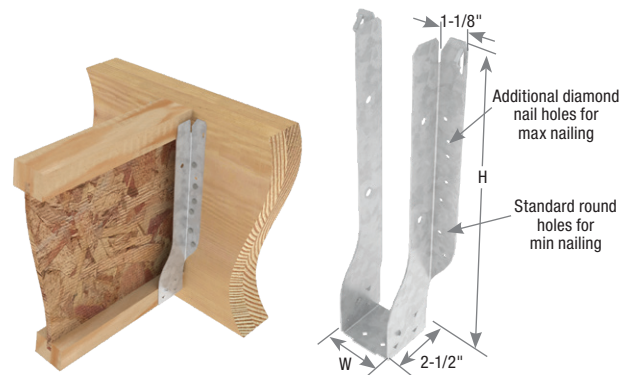

Typical IHFL2514 min nailing installation

IHFL2514

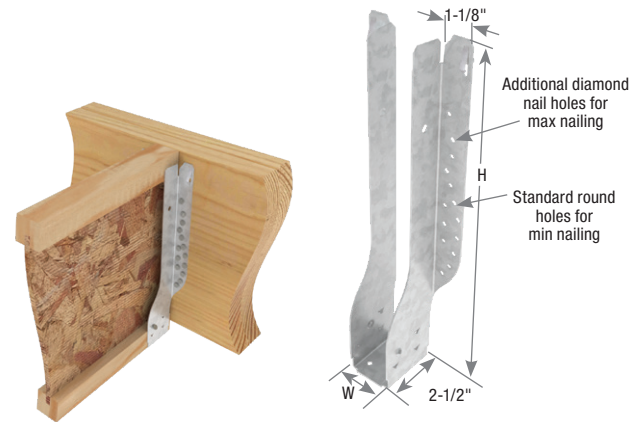

Typical IHF1714 max nailing installation

IHF1714

Raised Dimple nail holes allow 30° to 45° nailing into I-Joist bottom flange.

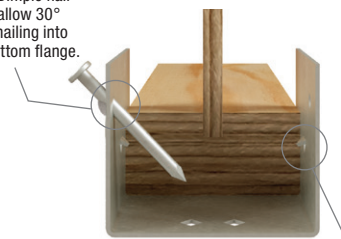

Seat Cleat® helps lock I-Joist into place for positive seating and nailing ease.

Specialty Options Chart – refer to Specialty Options pages 320-321 for additional details.

Option	Skewed ^{1,3,4,5}	Sloped Seat ^{2,3,4}	Sloped / Skewed ^{1,2,3,4}	Inverted Flange ⁴
Range	1° to 67-1/2° when width is 1-3/4" or less. 1° to 50° on all others.	1° to 45°	See Sloped Seat and Skewed	Not available in widths less than 2-1/4"
Allowable Loads	100% of table load. 75% of uplift load on skews greater than 15°.	100% of table load	80% of table load. 75% of uplift load on skews greater than 15°.	100% of table load. 65% of table load when nailing into the support members end grain.
Ordering	Add <i>SK</i> , angle required, right (<i>R</i>) or left (<i>L</i>), and square cut (<i>SQ</i>) or bevel cut (<i>BV</i>) to product number. Example: IHF23925_SK45R_BV	Add <i>SL</i> , slope required, and up (<i>U</i>) or down (<i>D</i>), to product number. Example: IHF23925_SL30D	See Sloped Seat and Skewed Example: IHF23925_SK45R_BV_SL30D	Add <i>IF</i> , to product number. Example: IHF23925_IF

- 1) Skewed hangers with skews greater than 15° may have all joist nailing on outside flange.
- 2) Sloped or sloped / skewed hangers with slopes greater than 15° may have additional joist nails.
- 3) For skewed hangers, the required cut type (square or bevel) of joist member may vary based on skew angle and width of hanger. Some square cut hangers will require custom pricing due to welded back plate.
- 4) Modifications to IHFL or IHF hangers do not feature seat cleats or optional nailing.
- 5) Skewed hangers may require web stiffeners to be installed in order to facilitate joist nail installation.

THF Face Mount I-Joist Hangers

Designed to provide lateral support for the top chords of I-Joists in depths up to 16".

Materials: See EWP Face Mount Hangers charts, page 217

Finish: G90 galvanizing

Options: See Specialty Options chart

Codes: IBC, FL, LA

Installation:

- Use all specified fasteners. See Product Notes, page 18.
- Web stiffeners are required for I-Joist installations.



Typical THF double I-Joist to LVL installation



Typical THF I-Joist to I-Joist installation

Specialty Options Chart – refer to Specialty Options pages 320-321 for additional details.

Option	Skewed ^{1,3}	Sloped Seat ^{2,3}	Sloped / Skewed ^{1,2,3}	Inverted Flange
Range	1° to 50°	1° to 45°	See Sloped Seat and Skewed	Not available in widths less than 2-1/4"
Allowable Loads	100% of table load. 75% of uplift load on skews greater than 15°.	100% of table load	80% of table load. 75% of uplift load on skews greater than 15°.	100% of table load. 65% of table load when nailing into the support members end grain.
Ordering	Add <i>SK</i> , angle required, right (<i>R</i>) or left (<i>L</i>), and square cut (<i>SQ</i>) or bevel cut (<i>BV</i>) to product number. Example: THF23118-2_SK45R_BV	Add <i>SL</i> , slope required, and up (<i>U</i>) or down (<i>D</i>), to product number. Example: THF23118-2_SL30D	See Sloped Seat and Skewed Example: THF23118-2_SK45R_BV_SL30D	Add <i>IF</i> , to product number. Example: THF23118-2_IF

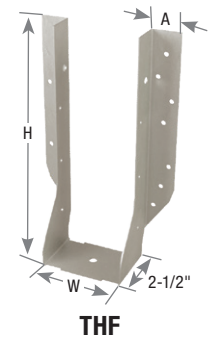

THF

- 1) Skewed hangers with skews greater than 15° may have all joist nailing on outside flange.
- 2) Sloped or sloped / skewed hangers with slopes greater than 15° may have additional joist nails.
- 3) For skewed hangers, the required cut type (square or bevel) of joist member may vary based on skew angle and width of hanger. Some square cut hangers will require custom pricing due to welded back plate.

Designed to support LVL, LSL, and PSL beams and headers in medium load conditions.

Materials: See EWP Face Mount Hangers charts, pages 218-220

Finish: G90 galvanizing

Options: See Specialty Options chart

Codes: See chart for code references

Installation:

- Use all specified fasteners. See Product Notes, page 18.
- **Min Nailing** – Fill all round nail holes.
- **Max Nailing** – Fill all round and diamond nail holes.



Typical HD installation

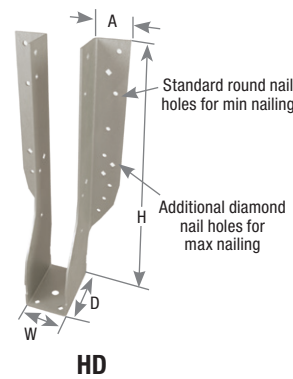

Specialty Options Chart – refer to Specialty Options pages 320-321 for additional details.

Option	Skewed ^{1,3}	Sloped Seat ^{2,3}	Sloped / Skewed ^{1,2,3}	Inverted Flange
Range	1° to 67-1/2° when width is 1-3/4" or less. 1° to 50° on all others.	1° to 45°	See Sloped Seat and Skewed	2-1/4" widths or greater (Widths < 2-1/4" may be available as a Custom, contact MiTek)
Allowable Loads	100% of table load. 75% of uplift load on skews greater than 15°.	100% of table load	80% of table load. 75% of uplift load on skews greater than 15°.	100% of table load. 65% of table load when nailing into the support members end grain.
Ordering	Add <i>SK</i> , angle required, right (<i>R</i>) or left (<i>L</i>), and square cut (<i>SQ</i>) or bevel cut (<i>BV</i>) to product number. Example: HD410_SK45R_SQ	Add <i>SL</i> , slope required, and up (<i>U</i>) or down (<i>D</i>), to product number. Example: HD410_SL30D	See Sloped Seat and Skewed Example: HD410_SK45R_SQ_SL30D	Add <i>IF</i> , to product number. Example: HD410_IF

- 1) Skewed hangers with skews greater than 15° may have all joist nailing on outside flange.
- 2) Sloped or sloped / skewed hangers with slopes greater than 15° may have additional joist nails.
- 3) For skewed hangers, the required cut type (square or bevel) of joist member may vary based on skew angle and width of hanger. Some square cut hangers will require custom pricing due to welded back plate.
- 4) HD option hangers may be manufactured as welded products to achieve listed loads. Welded products have a primer finish.

HDQIF Inverted Flange Face Mount Hangers

Inverted flange face mount hangers fasten to LVL, LSL and PSL beams and headers with WS Wood Screws.

Materials: See EWP Face Mount Hangers charts, pages 218-220

Finish: G90 galvanizing

Codes: IBC, FL, LA

Installation:

- Use all specified fasteners. See Product Notes, page 18.
- MiTek's WS15 (1/4" dia. x 1-1/2" long) and WS3 (1/4" dia. x 3" long) structural wood screws are supplied with HDQIF hangers.



**Typical HDQIF
inverted flange installation**

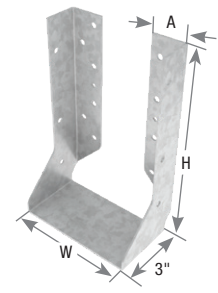

HDQIF

HUS Face Mount Hangers

Designed for medium load conditions. Extended 3" deep seat provides enhanced truss bearing.

Materials: 16 gauge

Finish: G90 galvanizing

Codes: IBC, FL, LA

Installation:

- Use all specified fasteners. See Product Notes, page 18.
- Joist nails must be driven at a 30° to 45° angle through the joist into the header to achieve listed loads. Slant/double shear nails must be used to achieve listed load values.



**Typical HUS
installation**

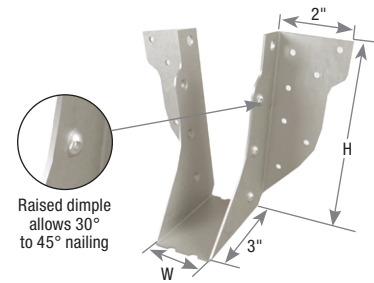

Raised dimple allows 30° to 45° nailing

HUS

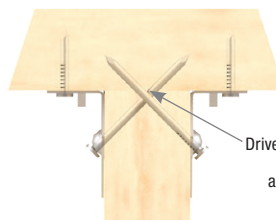

Drive joist nails into header at 30° to 45° to achieve listed loads.

**Typical HUS double
shear installation**

THD – Medium capacity hanger for LVL, LSL, and PSL beams

THDH – Heavy capacity hanger for LVL, LSL, and PSL beams

Materials: See EWP Face Mount Hangers charts, pages 218-220

Finish: G90 galvanizing

Options: Rough/ Full sizes available for THD series. THD hangers with widths greater than 3" can have one flange inverted with no load reduction. Specify left (L) or (R) flange. See Specialty Options chart.

Codes: IBC, FL, LA

Installation:

- Use all specified fasteners. See Product Notes, page 18.
- **THD** – Drive bend line nails into header at 45° to achieve listed loads.
- **THDH** – Drive joist nails into header at 30° to 45° to achieve listed loads.



Typical THDH installation



Typical THD installation

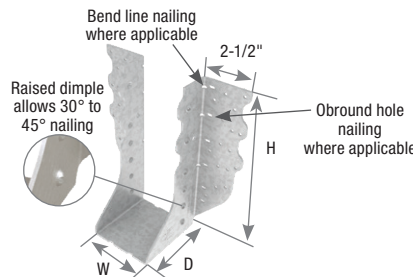

THDH

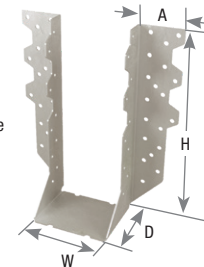

THD410

Some model designs may vary from illustration shown

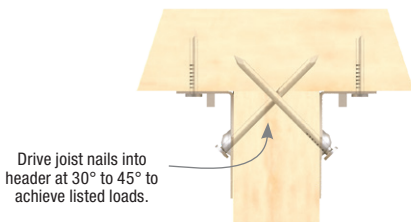

Typical THDH double shear installation

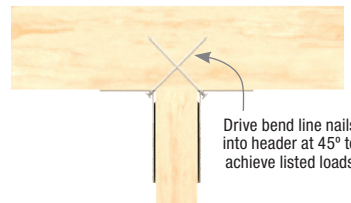

Typical bend line nailing installation

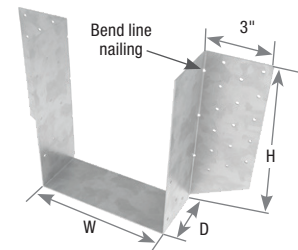

THD7210

Specialty Options Chart

– refer to Specialty Options pages 320-321 for additional details.

Option	MiTék Series	Skewed ^{1,3,4}	Sloped Seat ²	Sloped / Skewed ^{1,2,3,4}	Inverted Flange
Range	THD	1° to 45°	1° to 45°	See Sloped Seat and Skewed	THD410 – THD414 One flange
	THDH				THD610 – THD7210 Two flange
Allowable Loads	THD	85% of table load	65% of table load	65% of table load	100% of table load 65% of table load when nailing into the support members end grain
	THDH	85% of table load 50% of table uplift load	85% of table load	52% of table load 50% of table uplift load	N/A
Ordering	THD	Add <i>SK</i> , angle required, right (<i>R</i>) or left (<i>L</i>), and square cut (<i>SQ</i>) or bevel cut (<i>BV</i>) to product number. Ex. THDH410_SK45R_BV	Add <i>SL</i> , slope required, and up (<i>U</i>) or down (<i>D</i>), to product number. Ex: THDH410_SL30D	See Sloped Seat and Skewed Ex. THDH410_SK45R_BV_SL30D	One flange option: Add <i>IF</i> , and right (<i>R</i>) or left (<i>L</i>), to product number. Ex. THD410_IFR Two flange option: Add <i>IF</i> , to product number. Ex. THD610_IF
	THDH				N/A

1) Skewed hangers with skews greater than 15° may have all joist nailing on outside flange. All skewed THDH hangers have joist nails on one side only.
 2) Sloped or sloped / skewed hangers with slopes greater than 15° may have additional joist nails.
 3) THDH models - Skewed hangers typically require a bevel cut. A square cut option may be available as a custom.
 4) THD models - For skewed hangers, the required cut type (square or bevel) of joist member may vary based on skew angle and width of hanger. Some square cut hangers will require custom pricing due to welded back plate.

I-Joist Charts Face Mount Hangers

EWP Hangers

Joist Size (in)	MiTek Stock No.	Ref. No.	Web Stiff Req'd	Ga	Dimensions (in)				Fastener Schedule ³				DF/SP Header Allowable Loads (Lbs.)				S-P-F Header Allowable Loads (Lbs.)				Code Ref.	
					W	H	D	A	Min/Max	Header		Joist ²		100%	115%	125%	Uplift ^{1,2} 160%	100%	115%	125%		Uplift ^{1,2} 160%
										Qty	Type	Qty	Type									
1-1/2 x 9-1/4 - 9-1/2	IHFL15925	IUS1.56/9.5	--	18	1-1/2	9-1/16	2-1/2	1-1/8	--	8	10d	--	--	960	1095	1180	50	830	945	1020	40	IBC, FL, LA
	IHF15925	MIU1.56/9	--	16	1-1/2	9-1/16	2-1/2	1-1/8	Min	8	10d	2	10d x 1-1/2	1000	1120	1210	330	880	990	1065	260	
1-1/2 x 11-1/4 - 11-7/8	IHFL15112	IUS1.56/11.88	--	18	1-1/2	11-1/16	2-1/2	1-1/8	--	10	10d	--	--	1200	1370	1475	50	1040	1185	1275	40	
	IHF15112	MIU1.56/11	--	16	1-1/2	11-1/16	2-1/2	1-1/8	Min	10	10d	2	10d x 1-1/2	1250	1405	1515	330	1100	1235	1330	260	
1-1/2 x 14	IHF1514	--	--	16	1-1/2	13-1/2	2-1/2	1-1/8	Min	12	10d	2	10d x 1-1/2	1500	1685	1815	330	1320	1480	1595	260	
									Max	28	16d	2	10d x 1-1/2	3065	3095	3115	330	1815	1840	1860	260	
1-5/8 x 9-1/4 - 9-1/2	IHF16925	--	--	16	1-5/8	9	2-1/2	1-1/8	Min	8	10d	2	10d x 1-1/2	1000	1120	1210	330	880	990	1065	260	
									Max	20	16d	2	10d x 1-1/2	2905	2905	2905	330	1945	1975	1995	260	
1-5/8 x 11-1/4 - 12	IHF16112	--	--	16	1-5/8	11	2-1/2	1-1/8	Min	10	10d	2	10d x 1-1/2	1250	1405	1515	330	1100	1235	1330	260	
									Max	24	16d	2	10d x 1-1/2	3295	3325	3350	330	1945	1975	1995	260	
1-5/8 x 14	IHF1614	--	--	16	1-5/8	13-7/16	2-1/2	1-1/8	Min	12	10d	2	10d x 1-1/2	1500	1685	1815	330	1320	1480	1595	260	
									Max	28	16d	2	10d x 1-1/2	3295	3325	3350	330	1945	1975	1995	260	
1-3/4 x 9-1/4 - 9-1/2	IHFL17925	IUS1.81/9.5	--	18	1-3/4	8-15/16	2-1/2	1-1/8	--	8	10d	--	--	960	1095	1180	50	830	945	1020	40	
	IHF17925	MIU1.81/9	--	16	1-3/4	8-15/16	2-1/2	1-1/8	Min	8	10d	2	10d x 1-1/2	1000	1120	1210	330	880	990	1065	260	
1-3/4 x 11-7/8	IHFL17112	IUS1.81/11.88	--	18	1-3/4	10-15/16	2-1/2	1-1/8	--	10	10d	--	--	1200	1370	1475	50	1040	1185	1275	40	
	IHF17112	MIU1.81/11	--	16	1-3/4	10-15/16	2-1/2	1-1/8	Min	10	10d	2	10d x 1-1/2	1250	1405	1515	330	1100	1235	1330	260	
1-3/4 x 14	IHF1714	MIU1.81/14	--	16	1-3/4	13-3/8	2-1/2	1-1/8	Min	12	10d	--	--	1440	1640	1770	50	1245	1420	1530	40	
									Max	14	10d	--	--	1680	1915	2065	330	1455	1660	1785	260	
1-3/4 x 16	IHF1716	MIU1.81/16	--	16	1-3/4	13-3/8	2-1/2	1-1/8	Min	12	10d	2	10d x 1-1/2	1500	1685	1815	330	1320	1480	1595	260	
									Max	28	16d	2	10d x 1-1/2	3530	3560	3585	330	2080	2105	2125	260	
1-3/4 x 16	IHF1716	MIU1.81/16	--	16	1-13/16	15-3/4	2-1/2	1-1/8	Min	14	10d	--	--	1680	1915	2065	50	1455	1660	1785	40	
									Max	16	10d	--	--	1920	2190	2360	330	1660	1895	2040	260	
2 - 2-1/8 x 9-1/2	IHF20925	--	--	16	2-1/16	8-7/8	2-1/2	1-1/8	Min	8	10d	2	10d x 1-1/2	1000	1120	1210	330	880	990	1065	260	
									Max	20	16d	2	10d x 1-1/2	2905	2905	2905	330	2410	2440	2460	260	
2 - 2-1/8 x 11-7/8	IHF20112	MIU2.1/11	--	16	2-1/16	11-3/16	2-1/2	1-1/8	Min	10	10d	2	10d x 1-1/2	1250	1405	1515	330	1100	1235	1330	260	
									Max	24	16d	2	10d x 1-1/2	3530	3960	3960	330	2410	2440	2460	260	
2 - 2-1/8 x 14	IHF2014	--	--	16	2-1/16	13-1/4	2-1/2	1-1/8	Min	12	10d	--	--	1440	1640	1770	50	1245	1420	1530	40	
									Max	14	10d	--	--	1680	1915	2065	330	1455	1660	1785	260	
2 - 2-1/8 x 16	IHF2016	--	--	16	2-1/16	13-1/4	2-1/2	1-1/8	Min	12	10d	2	10d x 1-1/2	1500	1685	1815	330	1320	1480	1595	260	
									Max	28	16d	2	10d x 1-1/2	4115	4150	4170	330	2410	2440	2460	260	
2 - 2-1/8 x 16	IHF2016	--	--	16	2-1/16	15-11/16	2-1/2	1-1/8	Min	14	10d	--	--	1680	1915	2065	50	1455	1660	1785	40	
									Max	16	10d	--	--	1920	2190	2360	330	1660	1895	2040	260	
2-5/16 x 9-1/2	IHF23925	MIU2.37/9	--	16	2-5/16	9-3/16	2-1/2	1-1/8	Min	8	10d	2	10d x 1-1/2	960	1095	1180	50	830	945	1020	40	
									Max	24	16d	2	10d x 1-1/2	1250	1375	1375	330	1085	1085	1085	260	

1) Uplift loads have been increased 60% for wind or seismic loads; no further increase shall be permitted.
 2) IHFL (18GA) — install (2) 10d (0.148") x 1-1/2" nails through diamond dimple holes into the bottom chord of I-Joist member for a total uplift of 220 lbs.
 IHF (16GA) — uplift capacity for hangers installed without joist nails is 65 lbs.
 3) **NAILS:** 10d x 1-1/2 nails are 0.148" dia. x 1-1/2" long, 10d nails are 0.148" dia. x 3" long, 16d nails are 0.162" dia. x 3-1/2" long.
Load tables address hanger/header/fastener limitations only. Joist limitations must be determined for each installation.

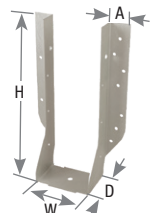

Continued on next page

EWP Hangers

Joist Size (in)	MiTek Stock No.	Ref. No.	Web Stiff Req'd	Ga	Dimensions (in)				Fastener Schedule ³				DF/SP Header Allowable Loads (Lbs.)				S-P-F Header Allowable Loads (Lbs.)				Code Ref.	
					W	H	D	A	Min/Max	Header		Joist ²		100%	115%	125%	Uplift ^{1,2}	100%	115%	125%		Uplift ^{1,2}
										Qty	Type	Qty	Type									
2-5/16 x 11-7/8	IHFL23112	IUS2.37/11.88	--	18	2-5/16	11-3/16	2-1/2	1-1/8	--	10	10d	--	--	1200	1370	1475	50	1040	1185	1275	40	
	IHF23112	MIU2.37/11	--	16	2-5/16	11-3/16	2-1/2	1-1/8	Min	10	10d	2	10d x 1-1/2	1250	1405	1515	330	1100	1235	1330	260	
2-5/16 x 14	IHFL2314	IUS2.37/14	--	18	2-5/16	13-1/2	2-1/2	1-1/8	Max	24	16d	--	--	1440	1640	1770	50	1245	1420	1530	40	
	IHF2314	MIU2.37/14	--	16	2-5/16	13-1/2	2-1/2	1-1/8	Min	12	10d	2	10d x 1-1/2	1500	1685	1815	330	1320	1480	1595	260	
2-5/16 x 16	IHFL2316	IUS2.37/16	--	18	2-5/16	15-9/16	2-1/2	1-1/8	Max	28	16d	--	--	1440	1640	1770	50	1455	1660	1785	40	
	IHF2316	MIU2.37/16	--	16	2-5/16	15-9/16	2-1/2	1-1/8	Min	14	10d	2	10d x 1-1/2	1750	1965	2120	330	1540	1730	1865	260	
2-5/16 x 18	IHF2318	MIU2.37/18	--	16	2-5/16	17-1/8	2-1/2	1-1/8	Max	30	16d	2	10d x 1-1/2	4410	4440	4440	330	2675	2705	2725	260	
	2-1/2 x 9-1/4 - 9-1/2	THFI2595	IUS2.56/9.25, IUS2.56/9.5	--	18	2-5/8	9-1/2	2-1/2	1-3/8	--	8	10d	--	--	960	1095	1180	125	845	965	995	100
IHF25925		MIU2.56/9	--	16	2-1/2	9-1/8	2-1/2	1-1/8	Min	10	10d	2	10d x 1-1/2	1250	1375	1375	330	1085	1085	1085	260	
2-1/2 x 11-1/4 - 11-7/8	THFI25118	IUS2.56/11.88	--	18	2-5/8	11-7/8	2-1/2	1-3/8	--	10	10d	--	--	1200	1265	1265	125	995	995	995	100	
	IHF25112	MIU2.56/11	--	16	2-1/2	11-1/8	2-1/2	1-1/8	Min	10	10d	2	10d x 1-1/2	1250	1375	1375	330	1085	1085	1085	260	
2-1/2 x 14	THFI2514	IUS2.56/14	--	18	2-5/8	14	2-1/2	1-3/8	Max	24	16d	--	--	1440	1640	1770	125	1265	1445	1555	100	
	IHF2514	MIU2.56/14	--	16	2-1/2	13-7/16	2-1/2	1-1/8	Min	12	10d	2	10d x 1-1/2	1500	1685	1815	330	1320	1480	1595	260	
2-1/2 x 16	IHFL2516	IUS2.56/16	--	18	2-1/2	15-1/2	2-1/2	1-1/8	Max	16	10d	--	--	1680	1915	2065	50	1455	1660	1785	40	
	IHF2516	MIU2.56/16	--	16	2-1/2	15-1/2	2-1/2	1-1/8	Min	14	10d	2	10d x 1-1/2	1750	1965	2120	330	1540	1730	1865	260	
2-5/8 x 9-1/4 - 9-1/2	IHF26925	--	--	16	2-5/8	9-1/16	2-1/2	1-1/8	Max	30	16d	2	10d x 1-1/2	4410	4440	4440	330	2675	2905	2920	260	
	2-5/8 x 11-1/4 - 11-7/8	IHF26112	--	--	16	2-5/8	11-1/16	2-1/2	1-1/8	Min	10	10d	2	10d x 1-1/2	1250	1375	1375	330	1085	1085	1085	260
2-5/8 x 14		IHF2614	--	--	16	2-5/8	13-3/8	2-1/2	1-1/8	Max	28	16d	2	10d x 1-1/2	3530	3960	3960	330	3010	3035	3055	260
	2-5/8 x 16	IHF2616	--	--	16	2-5/8	15-7/16	2-1/2	1-1/8	Min	14	10d	2	10d x 1-1/2	1500	1685	1815	330	1320	1480	1595	260
3 x 9-1/4		IHF15925-2	MIU3.12/9	--	16	3-1/8	9-3/16	2-1/2	1-1/8	Max	30	16d	2	10d x 1-1/2	4115	4440	4440	330	3010	3035	3055	260
	3 x 11-1/4	IHF15112-2	MIU3.12/11	--	16	3-1/8	10-13/16	2-1/2	1-1/8	Min	10	10d	2	10d x 1-1/2	1250	1375	1375	330	1085	1085	1085	260
									Max	24	16d			3530	3960	3960		3105	3125	3125		

IBC, FL, LA

Copyright © 2022 MiTek Industries, Inc. All Rights Reserved

- 1) Uplift loads have been increased 60% for wind or seismic loads; no further increase shall be permitted.
 - 2) IHFL (18GA) — install (2) 10d (0.148") x 1-1/2" nails through diamond dimple holes into the bottom chord of I-Joist member for a total uplift of 220 lbs. IHF (16GA) — uplift capacity for hangers installed without joist nails is 65 lbs.
 - 3) NAILS: 10d x 1-1/2 nails are 0.148" dia. x 1-1/2" long, 10d nails are 0.148" dia. x 3" long, 16d nails are 0.162" dia. x 3-1/2" long.
- Load tables address hanger/header/fastener limitations only. Joist limitations must be determined for each installation.

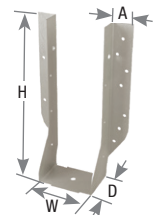

Continued on next page

I-Joist Charts Face Mount Hangers

EWP Hangers

Joist Size (in)	MiTek Stock No.	Ref. No.	Web Stiff Req'd	Ga	Dimensions (in)				Fastener Schedule ³				DF/SP Header Allowable Loads (Lbs.)				S-P-F Header Allowable Loads (Lbs.)				Code Ref.	
					W	H	D	A	Min/Max	Header		Joist ²		100%	115%	125%	Uplift ^{1,2}	100%	115%	125%		160%
										Qty	Type	Qty	Type									
3-1/4 x 9-1/4	IHF16925-2	--	--	16	3-3/8	9-1/16	2-1/2	1-1/8	Min	10	10d	2	10d x 1-1/2	1250	1375	1375	330	1085	1085	1085	260	
									Max	24	16d		3530	4000	4320	3105		3520	3720			
3-1/4 x 11-1/4	IHF16112-2	--	--	16	3-3/8	10-3/4	2-1/2	1-1/8	Min	10	10d	2	10d x 1-1/2	1250	1375	1375	330	1085	1085	1085	260	
									Max	24	16d		3530	3960	3960	3105		3125	3125			
3-1/2 x 9-1/4 - 9-1/2	IHFL35925	IUS3.56/9.5	--	18	3-1/2	8-5/8	2-1/2	1-1/8	--	10	10d	--	--	1200	1370	1475	50	1040	1185	1275	40	
	IHF35925	MIU3.56/9	--	16	3-1/2	8-5/8	2-1/2	1-1/8	Min	10	10d	2	10d x 1-1/2	1250	1375	1375	330	1085	1085	1085	260	
								Max	24	16d	2	10d x 1-1/2	3530	4000	4320	3105		3520	3800			
3-1/2 x 11-1/4 - 11-7/8	IHFL35112	IUS3.56/11.88	--	18	3-1/2	10-5/8	2-1/2	1-1/8	Min	10	10d	--	--	1200	1370	1475	50	1040	1185	1275	40	
								Max	12				1440	1640	1770	1245		1420	1530			
3-1/2 x 14	IHF35112	MIU3.56/11	--	16	3-1/2	10-5/8	2-1/2	1-1/8	Min	10	10d	2	10d x 1-1/2	1250	1375	1375	330	1085	1085	1085	260	
								Max	24	16d			3530	3960	3960	3105		3125	3125			
3-1/2 x 14	IHFL3514	IUS3.56/14	--	18	3-1/2	12-15/16	2-1/2	1-1/8	Min	12	10d	--	--	1440	1640	1770	50	1245	1420	1530	40	
								Max	14				1680	1915	2065	1455		1660	1785			
3-1/2 x 14	IHF3514	MIU3.56/14	--	16	3-1/2	12-15/16	2-1/2	1-1/8	Min	12	10d	2	10d x 1-1/2	1500	1685	1815	330	1320	1480	1595	260	
								Max	28	16d			4115	4440	4440	3620		3965	3985			
3-1/2 x 16	IHFL3516	IUS3.56/16	--	18	3-1/2	15	2-1/2	1-1/8	Min	14	10d	--	--	1680	1915	2065	50	1455	1660	1785	40	
									Max	16			1920	2190	2360	1660		1895	2040			
	IHF3516	MIU3.56/16	--	16	3-1/2	15	2-1/2	1-1/8	Min	14	10d	2	10d x 1-1/2	1750	1965	2120	330	1540	1730	1865	260	
									Max	30	16d		4410	4440	4440	3880		3965	3985			
	THF17157-2	--	x	12	3-5/8	15-3/4	2-1/2	1-1/4	--	22	10d	6	10d	2925	3365	3660	1275	2560	2945	3200	1115	
3-1/2 x 18	IHF3518	MIU3.56/18	--	16	3-1/2	16-9/16	2-1/2	1-1/8	Min	14	10d	2	10d x 1-1/2	1750	1965	2120	330	1540	1730	1865	260	
									Max	30	16d		4410	4440	4440	3880		3965	3985			
4 - 4-3/16 x 9-1/2	IHF20925-2	MIU4.12/9, MIU4.28/9	--	16	4-3/16	8-11/16	2-1/2	1-1/8	Min	10	10d	2	10d x 1-1/2	1250	1405	1515	330	1100	1235	1330	260	
									Max	24	16d		3530	3960	3960	3105		3120	3120			
4 - 4-3/16 x 11-7/8	IHF20112-2	MIU4.12/11, MIU4.28/11	--	16	4-3/16	11	2-1/2	1-1/8	Min	10	10d	2	10d x 1-1/2	1250	1405	1515	330	1100	1235	1330	260	
									Max	24	16d		3530	3960	3960	3105		3120	3120			
4 - 4-3/16 x 14	IHF2014-2	MIU4.12/14, MIU4.28/14	--	16	4-3/16	13-5/8	2-1/2	1-1/8	Min	12	10d	2	10d x 1-1/2	1500	1685	1815	330	1320	1480	1595	260	
									Max	28	16d		3960	3960	3960	3120		3120	3120			
4-5/8 x 9-1/4	IHF23925-2	MIU4.75/9	--	16	4-3/4	8-3/8	2-1/2	1-1/8	Min	10	10d	2	10d x 1-1/2	1250	1405	1515	330	1100	1235	1330	260	
									Max	24	16d		3530	3960	3960	3105		3120	3120			
4-5/8 x 11-1/4	THF23118-2	MIU4.75/11	x	16	4-3/4	10-11/16	2-1/2	1-1/4	--	16	10d	6	10d	1890	2170	2360	1135	1650	1900	2065	990	
4-5/8 x 14	THF23140-2	MIU4.75/14	x	12	4-3/4	13-5/16	2-1/2	1-1/4	--	20	10d	6	10d	2660	3060	3325	1275	2325	2675	2910	1115	
4-5/8 x 16	THF23160-2	MIU4.75/16	x	12	4-3/4	15-15/16	2-1/2	1-1/4	--	24	10d	6	10d	3190	3670	3990	1275	2790	3165	3165	1115	
5 x 9-1/4	IHF25925-2	MIU5.12/9	--	16	5-1/8	8-3/16	2-1/2	1-1/8	Min	10	10d	2	10d x 1-1/2	1250	1405	1515	330	1100	1235	1330	260	
									Max	24	16d		3530	3960	3960	3105		3120	3120			
5 x 11-1/4	IHF25112-2	MIU5.12/11	--	16	5-1/8	10-7/16	2-1/2	1-1/8	Min	10	10d	2	10d x 1-1/2	1250	1405	1515	330	1100	1235	1330	260	
									Max	24	16d		3530	3960	3960	3105		3120	3120			
5 x 14	THF25140-2	MIU5.12/14	x	12	5-1/8	13-1/8	2-1/2	1-1/4	--	20	10d	6	10d	2660	3060	3325	1275	2340	2690	2925	1015	
5 x 16	THF25160-2	MIU5.12/16	x	12	5-1/8	15-3/4	2-1/2	1-1/4	--	24	10d	6	10d	3190	3670	3990	1275	2810	3160	3160	1015	
7 x 9-1/4	HD7100	HU410-2	x	14	7-1/8	9	2-1/2	1-1/16	Min	14	16d	6	16d	2155	2430	2610	1305	1895	2140	2295	1035	
									Max	18		8	2770	3125	3355	1845	2440	2750	2950	1620		
7 x 11-1/4	HD7120	HU412-2	x	14	7-1/8	10-11/16	2-1/2	1-1/16	Min	16	16d	6	16d	2465	2780	2980	1305	2165	2445	2620	1035	
									Max	22		8	3390	3820	4100	1845	2980	3360	3605	1620		
7 x 14	HD7140	HU414-2	x	14	7-1/8	13	2-1/2	1-1/16	Min	20	16d	8	16d	3080	3475	3725	1845	2710	3055	3160	1620	
									Max	26		12	4005	4435	4435	2765	3520	3885	3885	2430		

IBC, FL, LA

Copyright © 2022 MiTek Industries, Inc. All Rights Reserved

- Uplift loads have been increased 60% for wind or seismic loads; no further increase shall be permitted.
- IHFL (18GA) — install (2) 10d (0.148") x 1-1/2" nails through diamond dimple holes into the bottom chord of I-Joist member for a total uplift of 220 lbs.
IHF (16GA) — uplift capacity for hangers installed without joist nails is 65 lbs.
- NAILS:** 10d x 1-1/2 nails are 0.148" dia. x 1-1/2" long, 10d nails are 0.148" dia. x 3" long, 16d nails are 0.162" dia. x 3-1/2" long.
Load tables address hanger/header/fastener limitations only. Joist limitations must be determined for each installation.

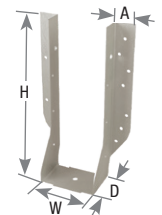

Continued on next page

EWP Hangers

Joist Size (in)	MiTek Stock No.	Ref. No.	Web Stiff Req'd	Ga	Dimensions (in)				Fastener Schedule ^{2,3}				DF/SP Header Allowable Loads (Lbs.)				S-P-F Header Allowable Loads (Lbs.)				Code Ref.		
					W	H	D	A	Min/Max	Header		Joist		100%	115%	125%	Uplift ¹ 160%	100%	115%	125%		Uplift ¹ 160%	
										Qty	Type	Qty	Type										
1-1/2 x 9-1/4 - 9-1/2	IHFL15925	IUS1.56/9.5	--	18	1-1/2	9-1/16	2-1/2	1-1/8	--	8	10d	--	--	960	1095	1180	50	830	945	1020	40		
1-1/2 x 11-1/4 - 11-7/8	IHFL15112	IUS1.56/11.88	--	18	1-1/2	11-1/16	2-1/2	1-1/8	--	10	10d	--	--	1200	1370	1475	50	1040	1185	1275	40		
1-1/2 x 14	IHF1514	--	--	16	1-1/2	13-1/2	2-1/2	1-1/8	Min	12	10d	2	10d x 1-1/2	1500	1685	1815	330	1320	1480	1595	260		
									Max	28	16d			3065	3095	3115		1815	1840	1860			
1-3/4 x 5-1/2	HUS175	HU1.81/5	x	16	1-13/16	5-3/8	3	2	--	14	16d	6	16d	2760	3140	3400	2045	2430	2765	2990	1640		
1-3/4 x 7-1/4	HD1770	HU7	x	14	1-13/16	7-1/8	2-1/2	1-1/8	Min	12	10d	4	10d x 1-1/2	1850	2085	2235	760	1625	1835	1900	610		
								Max	16	16d	8			2465	2780	2980		1190	2165	2445	2620	960	
	HUS177	--	x	16	1-13/16	7-1/8	3	2	--	22	16d	8	16d	4170	4745	5125	2990	3670	4130	4130	2410		
1-3/4 x 9-1/2	IHF17925	MIU1.81/9	--	16	1-3/4	8-15/16	2-1/2	1-1/8	Min	8	10d	2	10d x 1-1/2	1000	1120	1210	330	880	990	1065	260		
								Max	20	16d	2905			2905	2905	2080		2105	2125				
		HD17925	HU9	x	14	1-13/16	9-1/8	2-1/2	1-1/8	Min	18	16d	6	10d x 1-1/2	2770	3125	3355	1170	2440	2645	2695	955	
									Max	24	10	3695			4170	4320	1900		3020	3165	3255	1545	
		HD17925IF	--	x	14	1-13/16	9-1/8	--	1-1/8	--	18	16d	6	10d x 1-1/2	2770	3125	3355	1170	2440	2645	2695	950	
	HDQ1791F	HUCQ1.81/9-SDS	x	14	1-13/16	9	3	13/16	--	8	WS3	4	WS15	3340	3605	3605	1140	3080	3210	3295	1055		
	HUS179	HUS1.81/10	x	16	1-13/16	9-1/8	3	2	--	30	16d	10	16d	5580	6060	6060	4110	4555	4880	4910	3410		
1-3/4 x 11-1/4 - 11-7/8	IHF17112	MIU1.81/11	--	16	1-3/4	10-15/16	2-1/2	1-1/8	Min	10	10d	2	10d x 1-1/2	1250	1405	1515	330	1100	1235	1330	260		
								Max	24	16d	3530			3560	3585	2080		2105	2125				
		HD17112	HU11	x	14	1-13/16	11-3/8	2-1/2	1-1/8	Min	22	16d	6	10d x 1-1/2	3390	3625	3685	1170	2555	2645	2695	955	
									Max	30	12	4320			4515	4640	1900		3255	3425	3535	1550	
		HD17112IF	--	x	14	1-13/16	11-3/8	--	1-1/8	--	22	16d	6	10d x 1-1/2	3390	3625	3685	1170	2555	2645	2695	955	
	HDQ17112IF	HUCQ1.81/11-SDS	x	14	1-13/16	11	3	13/16	--	10	WS3	6	WS15	3605	3605	3605	1520	2915	2915	2915	1230		
	HUS179	HUS1.81/10	x	16	1-13/16	9-1/8	3	2	--	30	16d	10	16d	5580	6060	6060	4110	4555	4880	4910	3410		
1-3/4 x 14	IHF1714	MIU1.81/14	--	16	1-3/4	13-3/8	2-1/2	1-1/8	Min	12	10d	2	10d x 1-1/2	1500	1685	1815	330	1320	1480	1595	260		
								Max	28	16d	3530			3560	3585	2080		2105	2125	260			
		HD1714	HU14, U14	x	14	1-13/16	13-5/16	2-1/2	1-1/8	Min	28	16d	8	10d x 1-1/2	3790	3920	4005	1510	2790	2905	2975	1220	
									Max	36	14	4580			4810	4955	1900		3485	3685	3815	1555	
		HD1714IF	--	x	14	1-13/16	13-5/16	--	1-1/8	--	28	16d	8	10d x 1-1/2	3790	3920	4005	1510	2790	2905	2975	1220	
	HDQ1714IF	--	x	14	1-13/16	13-3/8	3	13/16	--	12	WS3	6	WS15	4660	4840	4840	1995	3335	3500	3610	1615		
	HUS179	HUS1.81/10	x	16	1-13/16	9-1/8	3	2	--	30	16d	10	16d	5580	6060	6060	4110	4555	4880	4910	3410		
1-3/4 x 16	IHF1716	MIU1.81/16	--	16	1-13/16	15-3/4	2-1/2	1-1/8	Min	14	10d	2	10d x 1-1/2	1750	1965	2120	330	1540	1730	1865	260		
								Max	30	16d	3530			3560	3585	2080		2105	2125				
		HD1714	HU14, U14	x	14	1-13/16	13-5/16	2-1/2	1-1/8	Min	28	16d	8	10d x 1-1/2	3790	3920	4005	1510	2790	2905	2975	1220	
									Max	36	14	4580			4810	4955	1900		3485	3685	3815	1555	
	HD1714IF	--	x	14	1-13/16	13-5/16	--	1-1/8	--	28	16d	8	10d x 1-1/2	3790	3920	4005	1510	2790	2905	2975	1220		
	HDQ1714IF	--	x	14	1-13/16	13-3/8	3	13/16	--	12	WS3	6	WS15	4660	4840	4840	1995	3335	3500	3610	1615		

IBC, FL, LA

Copyright © 2022 MiTek Industries, Inc. All Rights Reserved

1) Uplift loads have been increased 60% for wind or seismic loads; no further increase shall be permitted.
 2) WS15 structural wood screws are 1/4" dia. x 1-1/2" long, WS3 structural wood screws are 1/4" dia. x 3" long and are included with HDQ hangers.
 3) **NAILS:** 10d x 1-1/2 nails are 0.148" dia. x 1-1/2" long, 10d nails are 0.148" dia. x 3" long, 16d nails are 0.162" dia. x 3-1/2" long.
Load tables address hanger/header/fastener limitations only. Joist limitations must be determined for each installation.
 New products or updated product information are designated in **blue font**.

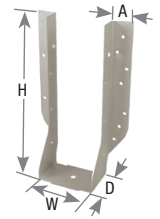

Continued on next page

Joist Size (in)	MiTek Stock No.	Ref. No.	Web Stiff Req'd	Ga	Dimensions (in)				Fastener Schedule ^{2,3}				DF/SP Header Allowable Loads (Lbs.)				S-P-F Header Allowable Loads (Lbs.)				Corrosion Finish	Code Ref.	
					W	H	D	A	Min/Max	Header		Joist		100%	115%	125%	Uplift ¹ 160%	100%	115%	125%			Uplift ¹ 160%
										Qty	Type	Qty	Type										
2-11/16 x 9-1/4 - 14	HD27925	HU2.75/10	x	14	2-3/4	9-3/16	2-1/2	1-1/8	Min	14	6	10d x 1-1/2	2155	2430	2610	1170	1895	2140	2295	950			
									Max	20	10		3080	3475	3725	1510	2710	3055	3200	1210			
	THDH27925	--	x	12	2-3/4	9-1/8	4	2-1/2	--	46	16d	12 16d	9020	9020	9020	4345	7515	7850	7850	3480			
2-11/16 x 11-1/4 - 16	HD27112	HU2.75/12	x	14	2-3/4	11-3/16	2-1/2	1-1/8	Min	16	8	10d x 1-1/2	2465	2780	2980	1190	2165	2445	2620	950			
									Max	24	12		3695	4170	4435	1900	3250	3665	3930	1530			
	THDH27112	--	x	12	2-3/4	10-7/8	4	2-1/2	--	56	16d	14 16d	9710	9710	9710	4345	7795	7795	7795	3490			
2-11/16 x 14 - 16	HD2714	HU2.75/14	x	14	2-3/4	13-3/16	2-1/2	1-1/8	Min	18	8	10d x 1-1/2	2770	3125	3355	1510	2440	2750	2950	1210			
									Max	26	12		4005	4435	4435	1900	3520	3935	3935	1530			
	THDH2714	--	x	12	2-3/4	12-1/4	4	2-1/2	--	66	16d	16 16d	11185	11325	11325	5290	8530	9045	9115	4260			
3-1/4 x 9-1/2	THDH3210	HGUS3.25/10	x	12	3-1/4	9-3/8	4	2-1/2	--	46	16d	12 16d	9020	9020	9020	4345	7830	7830	7830	3470			
3-1/4 x 10-5/8	THDH3212	HGUS3.25/12	x	12	3-1/4	10-5/8	4	2-1/2	--	56	16d	14 16d	9710	9710	9710	5290	7775	7775	7775	4235			
3-1/2 x 5-1/4	THD46	HHUS46	x	14	3-5/8	5-5/16	3	2	--	18	16d	12 10d	2770	3125	3355	2340	2440	2750	2950	2060			
	THDH46	HGUS46	x	12	3-5/8	5-5/16	4	2-1/2	--	20	16d	8 16d	4375	4895	5180	2805	3850	4115	4115	2225			
3-1/2 x 7-1/4	THD48	HHUS48	x	14	3-5/8	7-1/16	3	2	--	28	16d	16 10d	4310	4860	5005	2595	3795	4020	4020	2080			
	THDH48	HGUS48	x	12	3-5/8	7-1/16	4	2-1/2	--	36	16d	10 16d	7360	8175	8175	3000	6475	6505	6505	2385			
3-1/2 x 9-1/4 - 14	HD410	--	x	14	3-9/16	8-13/16	2-1/2	1-1/8	Min	14	6	10d	2155	2430	2610	1170	1895	2140	2295	1030			
									Max	20	10		3080	3475	3725	1950	2710	3055	3190	1715			
	HDQ410IF	HUCQ410-SDS	x	14	3-9/16	9	3	1-1/2	--	12	WS3	6 WS3	5015	5145	5145	2975	4480	4590	4590	2655		IBC, FL, LA	
	THD410	HHUS410	x	14	3-5/8	9-1/16	3	2	--	38	16d	20 10d	5850	6600	7045	3905	5145	5680	5680	3255			
	THDH410	HGUS410	x	12	3-5/8	9-1/16	4	2-1/2	--	46	16d	12 16d	9020	9020	9020	4345	7820	7820	7820	3470			
3-1/2 x 11-1/4 - 16	HD412	--	x	14	3-9/16	10-13/16	2-1/2	1-1/8	Min	16	8	10d	2465	2780	2980	1305	2165	2445	2620	1040			
									Max	24	12		3695	4170	4470	2340	3250	3665	3860	2060			
	HDQ412IF	HUCQ412-SDS	x	14	3-9/16	11	3	1-1/2	--	14	WS3	6 WS3	5605	5605	5605	3280	5605	5605	5605	3280			
	THD412	--	x	14	3-5/8	11	3	2	--	48	16d	20 10d	7045	7045	7045	3905	5680	5680	5680	3255			
	THDH412	HGUS412	x	12	3-5/8	11-1/16	4	2-1/2	--	56	16d	14 16d	9710	9710	9710	5290	7765	7765	7765	4230			
3-1/2 x 14 - 20	HD414	--	x	14	3-9/16	12-13/16	2-1/2	1-1/8	Min	18	8	10d	2770	3125	3355	1510	2440	2750	2950	1205			
									Max	26	12		4005	4515	4815	2340	3520	3860	3860	2060			
	THD414	--	x	14	3-5/8	12-7/8	3	2	--	58	16d	20 10d	7045	7045	7045	3905	5680	5680	5680	3255			
	THDH414	HGUS414	x	12	3-5/8	13-1/16	4	2-1/2	--	66	16d	16 16d	11325	11325	11325	5305	9075	9075	9075	4250			
3-1/2 x 16 - 22	HD416	--	x	14	3-9/16	14-13/16	2-1/2	1-1/8	Min	22	10	10d	3390	3820	4100	1950	2980	3360	3605	1715			
									Max	30	14		4620	4990	4990	2245	4015	4015	4015	1805			
3-1/2 x 18 - 26	HD418	--	x	14	3-9/16	16-1/2	2-1/2	1-1/8	--	28	16d	8 10d	4310	4815	4815	1560	3795	3835	3835	1375			
5-1/4 x 7-1/4	HD68	HU68	x	14	5-1/2	5-15/16	2-1/2	1-1/8	Min	10	4	16d	1540	1735	1865	920	1355	1525	1640	760			
									Max	14	6		2155	2430	2610	1305	1895	2140	2295	1035			
	HD68IF	HUC68	x	14	5-1/2	5-15/16	2-1/2	--	Min	10	4	16d	1540	1735	1865	920	1355	1525	1640	760			
									Max	14	6		2155	2430	2610	1305	1895	2140	2295	1035			

1) Uplift loads have been increased 60% for wind or seismic loads; no further increase shall be permitted.
 2) WS3 structural wood screws are 1/4" dia. x 3" long and are included with HDQ hangers.
 3) NAILS: 10d x 1-1/2 nails are 0.148" dia. x 1-1/2" long, 10d nails are 0.148" dia. x 3" long, 16d nails are 0.162" dia. x 3-1/2" long.
 Load tables address hanger/header/fastener limitations only. Joist limitations must be determined for each installation.
 New products or updated product information are designated in blue font.

Corrosion Finish Key ■ Stainless Steel ■ Gold Coat ■ HDG ■ Triple Zinc

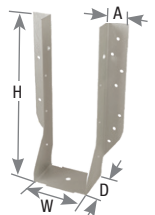

EWP Hangers

Continued on next page

Joist Size (in)	MiTek Stock No.	Ref. No.	Web Stiff Req'd	Ga	Dimensions (in)				Fastener Schedule ^{2,3}				DF/SP Header Allowable Loads (Lbs.)				S-P-F Header Allowable Loads (Lbs.)				Corrosion Finish	Code Ref.	
					W	H	D	A	Min/Max	Header		Joist		100%	115%	125%	Uplift ¹ 160%	100%	115%	125%			Uplift ¹ 160%
										Qty	Type	Qty	Type										
5-1/4 x 9-1/4 - 11-7/8	HD5210	--	x	14	5-3/8	7-7/8	2-1/2	1-1/8	Min	14	16d	6	16d	2155	2430	2610	1305	1895	2140	2295	1035		
									Max	20	16d	10	16d	3080	3475	3725	2305	2710	3055	3275	2025		
	HDQ5210IF	HUCQ5.25/9-SDS	x	14	5-1/4	9	3	1-1/2	--	12	WS3	6	WS3	5015	5145	5145	2975	4480	4570	4570	2645		
	THD610	HHUS5.50/10	x	12	5-1/2	9	3	2	--	38	16d	20	10d	6535	7255	7745	4035	5750	6380	6630	3230		
	THDH610	HGUS5.25/10, HGUS5.50/10	x	12	5-1/2	9	4	2-1/2	--	46	16d	16	16d	9020	9020	9020	5290	7805	7805	7805	4210		
5-1/4 x 11-1/4 - 16	HD5212	--	x	14	5-3/8	9-7/8	2-1/2	1-1/8	Min	16	16d	8	16d	2465	2780	2980	1305	2165	2445	2620	1040		
									Max	24	16d	12	16d	3695	4170	4470	2765	3250	3665	3930	2430		
	HDQ5212IF	HUCQ5.25/11-SDS	x	14	5-1/4	11	3	1-1/2	--	14	WS3	6	WS3	5605	5605	5605	3280	5605	5605	5605	3280		
	THD612	--	x	12	5-1/2	11	3	2	--	48	16d	20	10d	8255	8285	8285	4035	6630	6630	6630	3230		
	THDH612	HGUS5.25/12, HGUS5.50/12	x	12	5-1/2	11	4	2-1/2	--	56	16d	20	16d	9530	9530	9530	5290	7610	7610	7610	4225		
5-1/4 x 14 - 20	HD5214	--	x	14	5-3/8	11-7/8	2-1/2	1-1/8	Min	18	16d	8	16d	2770	3125	3355	1845	2440	2750	2950	1620		
									Max	26	16d	12	16d	4005	4515	4845	2765	3520	3970	4020	2430		
	THD614	--	x	12	5-1/2	12-7/8	3	2	--	58	16d	20	10d	8285	8285	8285	4035	6630	6630	6630	3230		
	THDH614	HGUS5.50/14	x	12	5-1/2	13	4	2-1/2	--	66	16d	22	16d	11325	11325	11325	5305	9055	9055	9055	4245		
5-1/4 x 16 - 22	HD5216	--	x	14	5-3/8	13-7/8	2-1/2	1-1/8	Min	22	16d	10	16d	3390	3820	4100	2305	2980	3360	3605	2025		
									Max	30	16d	14	16d	4620	4990	4990	3225	3995	3995	3995	2835		
6-3/4 x 9 - 14	THDH6710	HGUS210-4, HGUS6.88/10	x	12	6-7/8	8-13/16	4	2-1/2	--	46	16d	12	16d	9020	9020	9020	4345	7765	7765	7765	3445		
6-3/4 x 11 - 18	THDH6712	HGUS212-4, HGUS6.88/12	x	12	6-7/8	10-13/16	4	2-1/2	--	56	16d	14	16d	9020	9020	9020	5290	7775	7775	7775	4195		
6-3/4 x 13 - 20	THDH6714	HGUS214-4, HGUS6.88/14	x	12	6-7/8	12-13/16	4	2-1/2	--	66	16d	16	16d	11325	11325	11325	5305	8995	8995	8995	4215		
7 x 9-1/4 - 14	HD7100	HU410-2	x	14	7-1/8	9	2-1/2	1-1/16	Min	14	16d	6	16d	2155	2430	2610	1305	1895	2140	2295	1035		
									Max	18	16d	8	16d	2770	3125	3355	1845	2440	2750	2950	1620		
	THD7210	HHUS7.25/10	x	12	7-1/4	9	3	3	--	38	16d	20	10d	6535	7255	7745	4035	5750	6380	6605	3220		
	THDH7210	HGUS7.25/10	x	12	7-1/4	9	4	2-1/2	--	46	16d	12	16d	9020	9020	9020	4345	7760	7760	7760	3440		
7 x 11-1/4 - 16	HD7120	HU412-2	x	14	7-1/8	10-11/16	2-1/2	1-1/16	Min	16	16d	6	16d	2465	2780	2980	1305	2165	2445	2620	1035		
									Max	22	16d	8	16d	3390	3820	4100	1845	2980	3360	3605	1620		
	THDH7212	HGUS7.25/12	x	12	7-1/4	10-1/2	4	2-1/2	--	56	16d	14	16d	9020	9020	9020	5290	7770	7770	7770	4195		
7 x 14 - 20	HD7140	HU414-2	x	14	7-1/8	13	2-1/2	1-1/16	Min	20	16d	8	16d	3080	3475	3725	1845	2710	3055	3160	1620		
									Max	26	16d	12	16d	4005	4435	4435	2765	3520	3885	3885	2430		
	THDH7214	HGUS7.25/14	x	12	7-1/4	12-1/4	4	2-1/2	--	66	16d	16	16d	11325	11325	11325	5305	8990	8990	8990	4215		
7 x 16 - 22	HD7160	--	x	14	7-1/8	15-5/8	2-1/2	1-1/16	--	24	16d	8	10d	3695	4170	4435	1560	3250	3665	3870	1375		
7 x 18 - 26	HD7180	--	x	14	7-1/8	17-3/4	2-1/2	1-1/16	--	28	16d	8	10d	4310	4860	4940	1560	3795	3910	3910	1375		

IBC, FL, LA

Copyright © 2022 MiTek Industries, Inc. All Rights Reserved

1) Uplift loads have been increased 60% for wind or seismic loads; no further increase shall be permitted.

2) WS3 structural wood screws are 1/4" dia. x 3" long and are included with HDQ hangers.

3) **NAILS:** 10d nails are 0.148" dia. x 3" long, 16d nails are 0.162" dia. x 3-1/2" long.

New products or updated product information are designated in **blue font**.

Corrosion Finish Key ■ Stainless Steel ■ Gold Coat ■ HDG ■ Triple Zinc

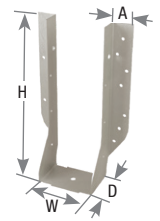

TFI / THO – Engineered for I-Joist to header applications. Offers full lateral support of the I-Joist top chord, eliminating the need for web stiffeners in most applications. Raised dimple nailing guides help assure correct 45° nailing into the I-Joist bottom flange. The THO's feature the patented Seat Cleat® that allows for quick, positive seating. The Seat Cleat® will hold the I-Joist in place, eliminating spring back during nailing in the bottom flange.

TFL – Features 1-1/2" top flange depth that accommodates all header types as well as back-to-back installations. Also features MiTek's patented Seat Cleat® for quick, positive seating.

Materials: See EWP Top Mount Hangers charts, pages 221-226

Finish: G90 galvanizing

Options: See Nailer Options Chart

Codes: IBC, FL, LA

Patents: U.S. Patent No. 5,564,248 – THO & TFL

Installation:

- Use all specified fasteners. See Product Notes, page 18.
- Refer to the top mount chart for applications requiring web stiffeners.
- Requirements for web stiffener from the I-Joist manufacturer should be followed, even if web stiffeners are not required in MiTek literature.
- Uplift capacity for THO and TFL single-ply hangers installed without joist nails = 85 lbs. Refer to THO, TFL, & THF Single-Ply I-Joist Hangers Technical Bulletin.



Typical THO installation



Typical TFL installation

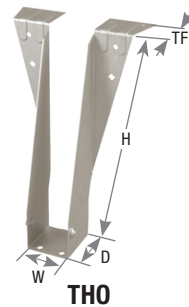

THO

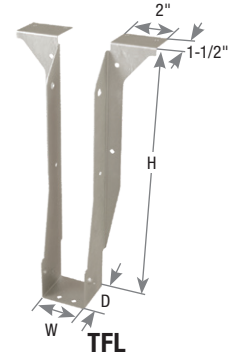

TFL

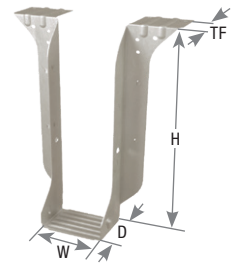
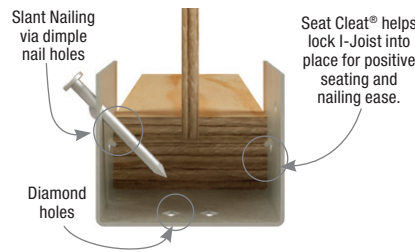

TFI

Nailer Options

– chart represents maximum allowable loads for hangers used on wood nailers. Reference page 203.

MiTek Series	Nailer Size	Fastener Schedule ³					DF/ SP		SPF	
		Nailer		Joist			Allowable Loads (Lbs.) ^{2,3}		Allowable Loads (Lbs.) ^{2,3}	
		Top Qty	Face Qty	Type	Qty	Type	Download 100%	Uplift ¹ 160%	Download 100%	Uplift ¹ 160%
TFL	2X	4	2	10d x 1-1/2	2	10d x 1-1/2	1270	130	1090	110
	3X	4	2	16d x 2-1/2	2	10d x 1-1/2	1600	130	1260	110
	(2) 2X	4	2	10d	2	10d x 1-1/2	1280	130	1100	110
	4X	4	2	16d	2	10d x 1-1/2	1745	130	1260	110
THO	2X	4	2	10d x 1-1/2	2	10d x 1-1/2	1235	230	950	195
	3X	4	2	16d x 2-1/2	2	10d x 1-1/2	1235	230	950	195
	(2) 2X	4	2	16d x 2-1/2	2	10d x 1-1/2	1235	230	950	195
	4X	4	2	16d	2	10d x 1-1/2	1235	230	950	195
THO (Double)	2X	4	2	10d x 1-1/2	2	10d x 1-1/2	1455	230	1250	195
	3X	4	2	16d x 2-1/2	2	10d x 1-1/2	2335	230	1815	195
	(2) 2X	4	2	10d	2	10d x 1-1/2	2370	230	1815	195
	4X	4	2	16d	2	10d x 1-1/2	2525	230	1815	195
TFI	2X	4	2	10d x 1-1/2	2	10d x 1-1/2	1985	215	1665	180
	3X	4	6	16d x 2-1/2	2	10d x 1-1/2	2715	215	2075	180
	(2) 2X	4	6	10d	2	10d x 1-1/2	2715	215	2075	180
	4X	4	2	16d	2	10d x 1-1/2	2560	215	2075	180
	4X	4	6	16d	2	10d x 1-1/2	3245	215	2075	180

1) Uplift loads have been increased 60% for wind or seismic loads; no further increase shall be permitted.

2) Listed loads shall not be increased.

3) Values in the table apply to standard top mount hangers without slope, skew or any other specialty options.

4) **NAILS:** 10d x 1-1/2 nails are 0.148" dia. x 1-1/2" long, 10d nails are 0.148" dia. x 3" long,

16d nails are 0.162" dia. x 3-1/2" long, 16d x 2-1/2 nails are 0.162" dia. x 2-1/2" long.

New products or updated product information are designated in blue font.

BPH / HBPH Top Mount Hangers

EWP Hangers

These hangers are used to support LVL, LSL, and PSL beams and headers in medium-to-heavy load conditions.

Materials: BPH – 12 gauge; HBPH – 10 gauge

Finish: G90 galvanizing

Options: See Nailer Options Chart and Specialty Options Chart

Codes: IBC, FL, LA

Installation:

- Use all specified fasteners. See Product Notes, page 18.
- Refer to the top mount chart for applications requiring web stiffeners.
- Requirements for web stiffener from the I-Joist manufacturer should be followed, even if web stiffeners are not required in MiTek literature.
- For welded installations, see page 325.



Typical BPH installation



Typical HBPH installation

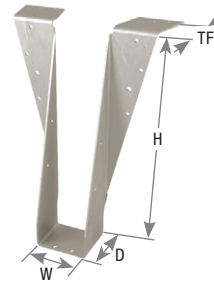

BPH

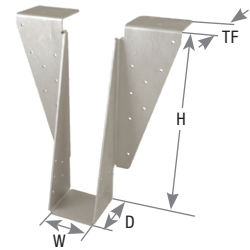

HBPH

Nailer Options

– chart represents maximum allowable loads for hangers used on wood nailers. Reference page 203.

MiTek Series	Nailer Size	Fastener Schedule ⁴					DF/SP		S-P-F	
		Header			Joist		Allowable Loads (Lbs.) ^{2,3}		Allowable Loads (Lbs.) ^{2,3}	
		Top Qty	Face Qty	Type	Qty	Type	Download 100%	Uplift ¹ 160%	Download 100%	Uplift ¹ 160%
BPH	2X	4	2	10d x 1-1/2	4	10d x 1-1/2	2080	230	1790	200
	3X	4	4	16d x 2-1/2	4	10d x 1-1/2	2360	535	2030	460
	(2) 2X	4	4	10d	4	10d x 1-1/2	2310	535	1985	460
	4X	4	4	16d	4	10d x 1-1/2	2245	535	1930	460
HBPH	2X	6	2	10d x 1-1/2	10	16d	2540	--	2135	--
	3X	6	6	16d x 2-1/2	10	10d	4500	--	3780	--
	(2) 2X	6	8	10d	10	16d	4140	1610	3480	1350
	4X	6	10	16d	10	16d	5745	1610	4825	1350

- 1) Uplift loads have been increased 60% for wind or seismic loads; no further increase shall be permitted.
- 2) Listed loads shall not be increased.
- 3) Values in the table apply to standard top mount hangers without slope, skew or any other specialty options.
- 4) **NAILS:** 10d x 1-1/2 nails are 0.148" dia. x 1-1/2" long, 10d nails are 0.148" dia. x 3" long, 16d nails are 0.162" dia. x 3-1/2" long, 16d x 2-1/2 nails are 0.162" dia. x 2-1/2" long.
New products or updated product information are designated in **blue font**.

Specialty Options Chart

– refer to Specialty Options pages 320 and 322 for additional details

Option	Skewed ^{1,3}	Sloped Seat ^{2,3}	Sloped / Skewed ^{1,2,3}	Sloped Top Flange ⁴
Range	1° to 50°	1° to 45°	See Sloped Seat and Skewed	0° to 45°
Allowable Loads	100% of table load	100% of table load	100% of table load	100% of table load
Ordering	Add <i>SK</i> , angle required, right (<i>R</i>) or left (<i>L</i>), and square cut (<i>SQ</i>) or bevel cut (<i>BV</i>) to product number. Example: BPH3595_SK45R_SQ	Add <i>SL</i> , slope required, and up (<i>U</i>) or down (<i>D</i>), to product number. Example: BPH3595_SL30D	See Sloped Seat and Skewed. Example: BPH3595_SK45R_SQ_SL30D	Add <i>SLTF</i> , angle required and right (<i>R</i>) or left (<i>L</i>), to product number. Example: BPH3595_SLTF30L

- 1) Skewed hangers with skews greater than 15° may have all joist nailing on outside flange.
- 2) Sloped or sloped / skewed hangers with slopes greater than 15° may have additional joist nails.
- 3) For skewed hangers, the required cut type (square or bevel) of joist member may vary based on skew angle and width of hanger. Some square cut hangers will require custom pricing due to welded back plate.
- 4) Sloped top flanges with slopes greater than 15° may have additional header nails.
New products or updated product information are designated in **blue font**.

Copyright © 2022 MiTek Industries, Inc. All Rights Reserved

Heavy-duty hanger for LVL, LSL, and PSL beams.

Materials: 7 gauge

Finish: Primer

Options: See Nailer Options Chart and Specialty Options Chart

Codes: IBC, FL, LA

Installation:

- Use all specified fasteners. See Product Notes, page 18.
- For welded installations, see page 325.
- 16d ring shank nails are supplied with HLBH hangers.

Nailer Options

– chart represents maximum allowable loads for hangers used on wood nailers. Reference page 203.



Typical HLBH installation

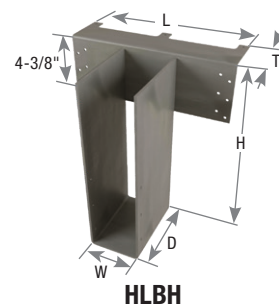

MiTek Series	Nailer Size	Fastener Schedule ⁴				DF/SP		SPF		
		Nailer		Joist		Allowable Loads (Lbs.) ^{2,3}		Allowable Loads (Lbs.) ^{2,3}		
		Top Qty	Face Qty	Type	Qty	Type	Download 100%	Uplift ¹ 160%	Download 100%	Uplift ¹ 160%
HLBH	2x	3	4	10d x 1-1/2	6	10d x 1-1/2	6115	--	5135	--
	3x	3	6	16d x 2-1/2	6	10d	6825	--	5735	--
	(2) 2x	3	8	10d	6	10d x 1-1/2	4385	--	3685	--
	4X	3	8	NA16D-RS	6	10d x 1-1/2	9600	1115	6900	935
	4X	3	8	NA16D-RS	6	16d	9600	1115	6900	935

- 1) Uplift loads have been increased 60% for wind or seismic loads; no further increase shall be permitted.
- 2) Listed loads shall not be increased.
- 3) **Values in the table apply to standard top mount hangers without slope, skew or any other specialty options.**
- 4) **NAILS:** 10d x 1-1/2 nails are 0.148" dia. x 1-1/2" long, 10d nails are 0.148" dia. x 3" long, NA16D-RS nails are 0.148 dia, x 3-1/2" long, 16d nails are 0.162" dia. x 3-1/2" long. New products or updated product information are designated in **blue font**.

Specialty Options Chart

– refer to Specialty Options pages 320, 322-323 for additional details

Option	Skewed ^{1,3}	Sloped Seat ^{2,3}	Sloped / Skewed ^{1,2,3}	Sloped Top Flange ⁴	Top Flange Offset	Saddle ⁵	Ridge
Range	1° to 50°	1° to 45°	See Sloped Seat and Skewed	0° to 45°	--	--	0° to 45°
Allowable Loads	8070 lbs. Max. 50% of uplift load on skew greater than 15°.	7000 lbs. Max.	6650 lbs. Max. 50% of uplift load on skew greater than 15°.	100% of table load	45% of table load	100% of table load per side. See footnote 5.	100% of table load
Ordering	Add <i>SK</i> , angle required, right (<i>R</i>) or left (<i>L</i>), and square cut (<i>SQ</i>) or bevel cut (<i>BI</i>) to product number. Ex. HLBH3595_SK45R_BV	Add <i>SL</i> , slope required, and up (<i>U</i>) or down (<i>D</i>), to product number. Ex. HLBH3595_SL30D	See Sloped Seat and Skewed. Ex. HLBH3595_SK45R_BV_SL30D	Add <i>SLTF</i> , angle required, and right (<i>R</i>) or left (<i>L</i>), to product number. Ex. HLBH3595_SLTF30L	Add <i>OS</i> , and right (<i>R</i>) or left (<i>L</i>), to product number. Ex. HLBH3595_OSL	Add <i>SA</i> , and saddle width required to product number. Ex. HLBH3595_SA=5-1/2"	Add <i>DA</i> , and angle required to product number. Ex. HLBH3595_DA30

- 1) Skewed hangers with skews greater than 15° may have all joist nailing on outside flange.
- 2) Sloped or sloped / skewed hangers with slopes greater than 15° may have additional joist nails.
- 3) Skewed hangers typically require a bevel cut however, a square cut option may be available as a custom when requested.
- 4) Sloped top flanges with slopes greater than 15° may have additional header nails.
- 5) Minimum header thickness shall be double the top flange (TF) dimension for 100% table load. New products or updated product information are designated in **blue font**.

PHM / PHXU Top Flange Hangers

EWP Hangers

Used to connect LVL, LSL, and PSL beams to headers in medium load conditions using standard nails.

Materials: See EWP Top Mount Hangers charts, pages 221-229

Finish: Primer; PHXU – G90 galvanizing

Options: See Nailer Options Chart and Specialty Options Chart

Codes: IBC, FL, LA

Patents: U.S. Patent No. 6,463,711 B1 – PHXU

Installation:

- Use all specified fasteners. See Product Notes, page 18.
- For welded installations, see page 325.

Nailer Options

– chart represents maximum allowable loads for hangers used on wood nailers. Reference page 203.

MiTek Series	Nailer Size	Fastener Schedule ⁵					DF/SP		SPF	
		Nailer		Joist			Allowable Loads (Lbs.) ^{1,4}		Allowable Loads (Lbs.) ^{1,4}	
		Top Qty	Face Qty	Type	Qty	Type	Download 100%	Uplift 160%	Download 100%	Uplift 160%
PHM	2X	2	--	10d x 1-1/2	2	10d x 1-1/2	3010	--	2140	--
	3X	2	--	16d x 2-1/2	2	10d x 1-1/2	3060	--	2140	--
	(2) 2X	2	--	10d	2	10d x 1-1/2	3060	--	2140	--
	4X	2	--	16d	2	10d x 1-1/2	3060	--	2140	--
PHXU ³ widths < 3-1/2"	2X	4	--	10d x 1-1/2	6	10d x 1-1/2	2585	--	2170	--
	3X	4	2	16d x 2-1/2	6	10d x 1-1/2	3855	--	3150	--
	(2) 2X	4	2	10d	6	10d x 1-1/2	3590	--	3015	--
	4X ³	4	4	16d	6	10d x 1-1/2	4420 ³	870	3150	730
PHXU ² widths ≥ 3-1/2"	2X	4	--	10d x 1-1/2	6	10d	2765	--	2325	--
	3X	4	2	16d x 2-1/2	6	10d	3895	--	3270	--
	(2) 2X	4	2	10d	6	10d	3785	--	3180	--
	4X	4	4	16d	6	10d x 1-1/2	5285	970	4545	835
	4X	4	4	16d	6	10d	5285	1120	4545	940

- 1) Listed loads shall not be increased.
- 2) Loads valid for hanger height ≤ 20". For hanger height ≥ 22", consult MiTek Engineering.
- 3) PHXU hangers with a width of less than 2-3/4" on 4x nailers are 4,350 lbs of download.
- 4) **Values in the table apply to standard top mount hangers without slope, skew or any other specialty options.**
- 5) **NAILS:** 10d x 1-1/2 nails are 0.148" dia. x 1-1/2" long, 10d nails are 0.148" dia. x 3" long, 16d nails are 0.162" dia. x 3-1/2" long, 16d x 2-1/2 nails are 0.162" dia. x 2-1/2" long. New products or updated product information are designated in **blue font**.

Specialty Options Chart

– refer to Specialty Options pages 320, 322-323 for additional details.

Option	MiTek Series	Skewed ^{1,3,5}	Sloped Seat ^{2,3}	Sloped / Skewed ^{1,2,3}	Sloped Top Flange ⁴	Top Flange Offset ⁵	Saddle ^{5,6}	Ridge
Range	PHM PHXU	1° to 84° 1° to 60°	1° to 45°	See Sloped Seat and Skewed	0° to 35°	--	--	0° to 45° N/A
Allowable Loads	PHM	100% of table load	100% of table load	100% of table load up to Max. load of 2500 lbs.	100% of table load	% of Hanger Width 3-1/2" or less 60% 3-9/16" to 5-1/2" 75% 5-9/16" to 7-1/2" 85%	100% of table load. See footnote 6.	100% of table load
	PHXU			100% of table load up to Max. load of 3900 lbs.				
Ordering	PHM	Add <i>SK</i> , angle required, right (<i>R</i>) or left (<i>L</i>), and square cut (<i>SQ</i>) or bevel cut (<i>BL</i>) to product number. Ex: PHXU1795_SK45R_SQ	Add <i>SL</i> , slope required, and up (<i>U</i>) or down (<i>D</i>), to product number. Ex: PHXU1795_SL30D	See Sloped Seat and Skewed. Ex: PHXU1795_SK45R_SQ_SL30D	Add <i>SLTF</i> , angle required, and right (<i>R</i>) or left (<i>L</i>), to product number. Ex: PHXU1795_SLTF30L	Add <i>OS</i> , and right (<i>R</i>) or left (<i>L</i>), to product number. Ex: PHXU1795_OSL	Add <i>SA</i> , and saddle width required to product number. Ex: PHXU1795_SA=5-1/2"	Add <i>DA</i> , and angle required to product number. Ex. PHXU1795_DA30 N/A
	PHXU							

- 1) Skewed hangers with skews greater than 15° may have all joist nailing on outside flange.
- 2) Sloped or sloped/skewed hangers with slopes greater than 15° may have additional joist nails.
- 3) For skewed hangers, the required cut type (square or bevel) of joist member may vary based on skew angle and width of hanger. Some square cut hangers will require custom pricing due to welded back plate.
- 4) Sloped top flanges with slopes greater than 15° may have additional header nails.
- 5) Skewed, top flange offset, or saddle options will have a solid, welded top flange.
- 6) Minimum header thickness shall be double the top flange (TF) dimension for 100% table load. New products or updated product information are designated in **blue font**.



Typical PHXU installation

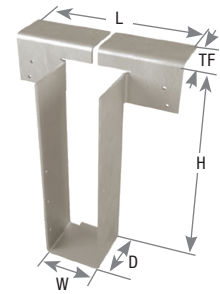

PHXU

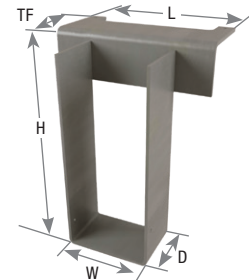

PHM

Joist Size (in)	MiTek Stock No.	Ref. No.	Web Stiff Req'd	Ga	Dimensions (in)					Fastener Schedule ⁵					Allowable Loads Header Type (Lbs.) ^{1,3}							Code Ref.
					W	H	D	L	TF	Header		Joist			Download 100%				Uplift ²			
										Top Qty	Face Qty	Type	Qty	Type	LVL	PSL	LSL	SPF	I-Joist ⁴	DF/SP	DF/SP 160%	
1-1/2 x 9-1/4	THO15925	--	--	18	1-9/16	9-1/4	2	--	1-1/2	4	2	10d	2	10d x 1-1/2	1235	1235	1235	955	1005	1235	230	IBC, FL, LA
	BPH15925	--	x	12	1-9/16	9-1/4	2-3/8	--	1-1/2	4	6	16d	4	10d x 1-1/2	2830	2830	2830	2095	--	2825	850	
1-1/2 x 9-1/2	THO15950	--	--	18	1-1/2	9-1/2	2	--	1-1/2	4	2	10d	2	10d x 1-1/2	1235	1235	1235	955	1090	1235	230	
	BPH1595	BA1.56/9.5	x	12	1-9/16	9-1/2	2-3/8	--	1-1/2	4	6	16d	4	10d x 1-1/2	2830	2830	2830	2095	--	2825	850	
1-1/2 x 11-1/4	BPH15112	--	x	12	1-9/16	11-1/4	2-3/8	--	1-1/2	4	6	16d	4	10d x 1-1/2	2830	2830	2830	2095	--	2825	850	
1-1/2 x 11-7/8	THO15118	ITS1.56/11.88	--	18	1-1/2	11-7/8	2	--	1-9/16	4	2	10d	2	10d x 1-1/2	1235	1235	1235	955	1205	1235	230	
	BPH15118	BA1.56/11.88	x	12	1-9/16	11-7/8	2-3/8	--	1-1/2	4	6	16d	4	10d x 1-1/2	2830	2830	2830	2095	--	2825	850	
1-1/2 x 14	THO15140	--	--	16	1-9/16	14	2-3/8	--	1-1/2	4	6	10d	2	10d x 1-1/2	1235	1235	1235	950	1030	1235	230	
	BPH1514	--	x	12	1-9/16	14	2-3/8	--	1-1/2	4	6	16d	4	10d x 1-1/2	2830	2830	2830	2095	--	2825	850	
1-5/8 x 9-1/2	THO16950	--	--	18	1-11/16	9-1/2	2	--	1-1/2	4	2	10d	2	10d x 1-1/2	1235	1235	1235	955	1005	1235	230	
1-5/8 x 11-1/4	THO16112	--	--	16	1-11/16	11-1/4	2	--	1-1/2	4	2	10d	2	10d x 1-1/2	1235	1235	1235	955	1030	1235	230	
1-5/8 x 11-7/8	THO16118	--	--	16	1-11/16	11-7/8	2	--	1-1/2	4	2	10d	2	10d x 1-1/2	1235	1235	1235	955	1030	1235	230	
1-5/8 x 14	THO16140	--	--	16	1-11/16	14	3	--	1-3/4	4	6	10d	2	10d x 1-1/2	2370	2370	2370	2185	1030	2370	230	
1-3/4 x 7-1/4	PHXU17725	WP1.81 H=7.25	x	7	1-13/16	7-1/4	3-1/4	10	2-1/2	4	4	16d	6	10d x 1-1/2	4350	4350	4350	3245	--	4350	930	
1-3/4 x 9-1/4	BPH17925	BA1.81/9.25	x	12	1-13/16	9-1/4	2-3/8	--	1-11/16	4	6	16d	4	10d x 1-1/2	2970	2970	2970	2300	--	2970	850	
	PHM17925	WP1.81 H=9.25	x	7/10	1-13/16	9-1/4	2-1/2	7	3	2	--	16d	2	10d x 1-1/2	3335	3335	3335	2140	--	3060	--	
	PHXU17925	--	x	7	1-13/16	9-1/4	3-1/4	10	2-1/2	4	4	16d	6	10d x 1-1/2	4350	4350	4350	3245	--	4350	930	
1-3/4 x 9-1/2	THO17950	ITS1.81/9.5	--	18	1-3/4	9-1/2	2	--	1-1/2	4	2	10d	2	10d x 1-1/2	1235	1235	1235	950	1235	1235	230	
	BPH1795	BA1.81/9.5, MIT9.5	x	12	1-13/16	9-1/2	2-3/8	--	1-11/16	4	6	16d	4	10d x 1-1/2	2970	2970	2970	2300	--	2970	850	
	PHM1795	WP1.81 H=9.5	x	7/10	1-13/16	9-1/2	2-1/2	7	3	2	--	16d	2	10d x 1-1/2	3335	3335	3335	2140	--	3060	--	
	PHXU1795	--	x	7	1-13/16	9-1/2	3-1/4	10	2-1/2	4	4	16d	6	10d x 1-1/2	4350	4350	4350	3245	--	4350	930	
1-3/4 x 11-1/4	BPH17112	BA1.81/11.25	x	12	1-13/16	11-1/4	2-3/8	--	1-11/16	4	6	16d	4	10d x 1-1/2	2970	2970	2970	2300	--	2970	850	
	PHM17112	WP1.81 H=11.25	x	7/10	1-13/16	11-1/4	2-1/2	7	3	2	--	16d	2	10d x 1-1/2	3335	3335	3335	2140	--	3060	--	
	PHXU17112	--	x	7	1-13/16	11-1/4	3-1/4	10	2-1/2	4	4	16d	6	10d x 1-1/2	4350	4350	4350	3245	--	4350	930	
1-3/4 x 11-7/8	THO17118	ITS1.81/11.88, MIT11.88	--	18	1-3/4	11-7/8	2	--	1-9/16	4	2	10d	2	10d x 1-1/2	1235	1235	1235	950	1235	1235	230	
	BPH17118	BA1.81/11.88	x	12	1-13/16	11-7/8	2-3/8	--	1-11/16	4	6	16d	4	10d x 1-1/2	2970	2970	2970	2300	--	2970	850	
	PHM17118	WP1.81 H=11.875	x	7/10	1-13/16	11-7/8	2-1/2	7	3	2	--	16d	2	10d x 1-1/2	3335	3335	3335	2140	--	3060	--	
	PHXU17118	--	x	7	1-13/16	11-7/8	3-1/4	10	2-1/2	4	4	16d	6	10d x 1-1/2	4350	4350	4350	3245	--	4350	930	
1-3/4 x 14	TFL1714	ITS1.81/14	--	18	1-3/4	14	2	--	1-1/2	4	2	10d	2	10d x 1-1/2	1585	1585	1585	1215	1245	1585	130	
	BPH1714	BA1.81/14, MIT1.81/14	x	12	1-13/16	14	2-3/8	--	1-11/16	4	6	16d	4	10d x 1-1/2	2970	2970	2970	2300	--	2970	850	
	PHM1714	WP1.81 H=14	x	7/10	1-13/16	14	2-1/2	7	3	2	--	16d	2	10d x 1-1/2	3335	3335	3335	2140	--	3060	--	
	PHXU1714	--	x	7	1-13/16	14	3-1/4	10	2-1/2	4	4	16d	6	10d x 1-1/2	4350	4350	4350	3245	--	4350	930	
1-3/4 x 16	TFL1716	ITS1.81/16	--	18	1-3/4	16	2	--	1-1/2	4	2	10d	2	10d x 1-1/2	1585	1585	1585	1215	1245	1585	130	
	BPH1716	BA1.81/16, MIT1.81/16	x	12	1-13/16	16	2-3/8	--	1-11/16	4	6	16d	4	10d x 1-1/2	2970	2970	2970	2300	--	2970	850	
	PHM1716	WP1.81 H=16	x	7/10	1-13/16	16	2-1/2	7	3	2	--	16d	2	10d x 1-1/2	3335	3335	3335	2140	--	3060	--	
2 - 2-1/8 x 9-1/2	TFL2095	ITS2.06/9.5	--	18	2-1/8	9-1/2	2	--	1-1/2	4	2	10d	2	10d x 1-1/2	1585	1585	1585	1215	1245	1585	130	
2 - 2-1/8 x 11-7/8	TFL20118	ITS2.06/11.88	--	18	2-1/8	11-7/8	2	--	1-1/2	4	2	10d	2	10d x 1-1/2	1585	1585	1585	1215	1245	1585	130	
2 - 2-1/8 x 14	TFL2014	ITS2.06/14	--	18	2-1/8	14	2	--	1-1/2	4	2	10d	2	10d x 1-1/2	1585	1585	1585	1215	1245	1585	130	

- When I-joist is used as a header, all header nails must be 10d (0.148") x 1-1/2.
 - Uplift loads have been increased 60% for wind or seismic loads; no further increase shall be permitted
 - Some listed loads may be increased for short-term loading. Refer to MiTek code evaluation reports for details.
 - When I-Joists with flanges less than 1-1/2" thick are used as headers, the reduction factor for 1-1/4" flange is 0.69 and 0.84 for 1-3/8" flange.
 - NAILS:** 10d x 1-1/2 nails are 0.148" dia. x 1-1/2" long, 10d nails are 0.148" dia. x 3" long, 16d nails are 0.162" dia. x 3-1/2" long.
- Load tables address hanger/header/fastener limitations only. Joist limitations must be determined for each installation.**

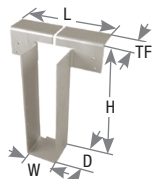

Continued on next page

Joist Size (in)	MiTek Stock No.	Ref. No.	Web Stiff Req'd	Ga	Dimensions (in)					Fastener Schedule ⁵					Allowable Loads Header Type (Lbs.) ^{1,3}						Code Ref.	
					W	H	D	L	TF	Header			Joist		Download 100%				Uplift ²			
										Top Qty	Face Qty	Type	Qty	Type	LVL	PSL	LSL	SPF	DF I-Joist ⁴	DF/SP		DF/SP 160%
2 - 2-1/8 x 16	TFL2016	ITS2.06/16	--	18	2-1/8	16	2	--	1-1/2	4	2	10d	2	10d x 1-1/2	1585	1585	1585	1215	1245	1585	130	
2-1/4 - 2-5/16 x 9-1/2	TFL2395	ITS2.37/9.5	--	18	2-5/16	9-1/2	2	--	1-1/2	4	2	10d	2	10d x 1-1/2	1585	1585	1585	1215	1245	1585	130	
2-1/4 - 2-5/16 x 11-7/8	TFL23118	ITS2.37/11.88	--	18	2-5/16	11-7/8	2	--	1-1/2	4	2	10d	2	10d x 1-1/2	1585	1585	1585	1215	1245	1585	130	
2-1/4 - 2-5/16 x 14	TFL2314	ITS2.37/14	--	18	2-5/16	14	2	--	1-1/2	4	2	10d	2	10d x 1-1/2	1585	1585	1585	1215	1245	1585	130	
	THO23140	BA2.37/14	--	18	2-3/8	14	2-3/8	--	2	4	8	10d	2	10d x 1-1/2	2400	2400	2400	1840	2400	2400	230	
	TFI3514	MIT3514	--	16	2-3/8	14	2-1/2	--	2-1/16	4	2	16d	2	10d x 1-1/2	2715	2715	2715	2080	--	2715	215	
	PHM2314	WP2.37 H=14	x	7/10	2-3/8	14	2-1/2	7	3	2	--	16d	2	10d x 1-1/2	3335	3335	3335	2535	--	3335	--	
2-1/4 - 2-5/16 x 16	TFL2316	ITS2.37/16	--	18	2-5/16	16	2	--	1-1/2	4	2	10d	2	10d x 1-1/2	1585	1585	1585	1215	1245	1585	130	
	TFI3516	MIT3516	--	16	2-3/8	16	2-1/2	--	2-1/16	4	2	16d	2	10d x 1-1/2	2715	2715	2715	2080	--	2715	215	
	PHM2316	WP2.37 H=16	x	7/10	2-3/8	16	2-1/2	7	3	2	--	16d	2	10d x 1-1/2	3335	3335	3335	2535	--	3335	--	
2-1/4 - 2-5/16 x 18	TFI3518	BA2.37/18, MIT3518	--	16	2-3/8	18	2-1/2	--	2-1/16	4	2	16d	2	10d x 1-1/2	2715	2715	2715	2080	--	2715	215	
	PHM2318	WP2.37 H=18	x	7/10	2-3/8	18	2-1/2	7	3	2	--	16d	2	10d x 1-1/2	3335	3335	3335	2535	--	3335	--	
2-1/4 - 2-5/16 x 20	TFI3520	BA2.37/20, MIT3520	--	16	2-3/8	20	2-1/2	--	2-1/16	4	2	16d	2	10d x 1-1/2	2715	2715	2715	2080	--	2715	215	
	PHM2320	WP2.37 H=20	x	7/10	2-3/8	20	2-1/2	7	3	2	--	16d	2	10d x 1-1/2	3335	3335	3335	2535	--	3335	--	
2-1/2 x 9-1/4	TFL25925	--	--	18	2-1/2	9-1/4	2	--	1-1/2	4	2	10d	2	10d x 1-1/2	1585	1585	1585	1215	1245	1585	130	
2-1/2 x 9-3/8	TFL25938	--	--	18	2-1/2	9-3/8	2	--	1-1/2	4	2	10d	2	10d x 1-1/2	1585	1585	1585	1215	1245	1585	130	
2-1/2 x 9-1/2	TFL2595	ITS2.56/9.5	--	18	2-1/2	9-1/2	2	--	1-1/2	4	2	10d	2	10d x 1-1/2	1585	1585	1585	1215	1245	1585	130	
2-1/2 x 11-1/4	TFL25112	--	--	18	2-1/2	11-1/4	2	--	1-1/2	4	2	10d	2	10d x 1-1/2	1585	1585	1585	1215	1245	1585	130	
2-1/2 x 11-7/8	TFL25118	ITS2.56/11.88	--	18	2-1/2	11-7/8	2	--	1-1/2	4	2	10d	2	10d x 1-1/2	1585	1585	1585	1215	1245	1585	130	
	THO25118	MIT311.88	--	16	2-9/16	11-7/8	2-3/8	--	1-15/16	4	6	10d	2	10d x 1-1/2	2370	2370	2370	2095	1835	2370	230	
2-1/2 x 13	TFL2513	--	--	18	2-1/2	13	2	--	1-1/2	4	2	10d	2	10d x 1-1/2	1585	1585	1585	1215	1245	1585	130	IBC, FL, LA
2-1/2 x 14	TFL2514	ITS2.56/14	--	18	2-1/2	14	2	--	1-1/2	4	2	10d	2	10d x 1-1/2	1585	1585	1585	1215	1245	1585	130	
	THO25140	MIT314	--	18	2-9/16	14	2-3/8	--	2	4	8	10d	2	10d x 1-1/2	2400	2400	2400	1835	2400	2400	230	
	TFI314	--	--	16	2-9/16	14	2-1/2	--	2	4	2	16d	2	10d x 1-1/2	2715	2715	2715	2080	--	2715	215	
	PHM2514	WP2.56 H=14	--	7/10	2-9/16	14	2-1/2	7	3	2	--	16d	2	10d x 1-1/2	3335	3335	3335	2535	--	3335	--	
2-1/2 x 16	TFL2516	ITS2.56/16	--	18	2-1/2	16	2	--	1-1/2	4	2	10d	2	10d x 1-1/2	1585	1585	1585	1215	1245	1585	130	
	TFI316	BA2.56/16, MIT316	--	16	2-9/16	16	2-1/2	--	2	4	2	16d	2	10d x 1-1/2	2715	2715	2715	2080	--	2715	215	
	PHM2516	WP2.56 H=16	--	7/10	2-9/16	16	2-1/2	7	3	2	--	16d	2	10d x 1-1/2	3335	3335	3335	2535	--	3335	--	
2-1/2 x 18	TFI318	HIT318, BA2.56/18, MIT318	--	16	2-9/16	18	2-1/2	--	2	4	2	16d	2	10d x 1-1/2	2715	2715	2715	2080	--	2715	215	
2-1/2 x 20	TFI320	HIT320, BA2.56/20, MIT320	--	16	2-9/16	20	2-1/2	--	2	4	2	16d	2	10d x 1-1/2	2715	2715	2715	2080	--	2715	215	
2-1/2 x 22	TFI322	HIT322, BA2.56/22, WP2.56 H=22	--	16	2-9/16	22	2-1/2	--	2	4	6	16d	2	10d x 1-1/2	2820	2820	2820	2485	--	2820	215	
2-1/2 x 24	TFI324	HIT324, BA2.56/24, WP2.56 H=24	--	16	2-9/16	24	2-1/2	--	2	4	6	16d	2	10d x 1-1/2	2820	2820	2820	2485	--	2820	215	
2-1/2 x 26	TFI326	BA2.56/26, WP2.56 H=26	--	16	2-9/16	26	2-1/2	--	2	4	6	16d	2	10d x 1-1/2	2820	2820	2820	2485	--	2820	215	
2-5/8 x 9-1/2	THO26950	--	--	18	2-11/16	9-1/2	2-3/8	--	2	4	6	10d	2	10d x 1-1/2	2525	2525	2525	2070	1625	2525	230	
2-5/8 x 11-7/8	THO26118	--	--	16	2-11/16	11-7/8	2-3/8	--	2	4	6	10d	2	10d x 1-1/2	2370	2370	2370	2115	1835	2370	230	
2-5/8 x 14	THO26140	--	--	18	2-11/16	14	2-3/8	--	2	4	8	10d	2	10d x 1-1/2	2400	2400	2400	1835	2400	2400	230	
2-5/8 x 16	THO26160	--	--	18	2-11/16	16	2-3/8	--	2	4	8	10d	2	10d x 1-1/2	2400	2400	2400	1835	2400	2400	230	

- 1) When I-joist is used as a header, all header nails must be 10d (0.148") x 1-1/2.
 - 2) Uplift loads have been increased 60% for wind or seismic loads; no further increase shall be permitted
 - 3) Some listed loads may be increased for short-term loading. Refer to MiTek code evaluation reports for details.
 - 4) When I-joists with flanges less than 1-1/2" thick are used as headers, the reduction factor for 1-1/4" flange is 0.69 and 0.84 for 1-3/8" flange.
 - 5) **NAILS:** 10d x 1-1/2 nails are 0.148" dia. x 1-1/2" long, 10d nails are 0.148" dia. x 3" long, NA16D-RS nails are 0.148" x 3-1/2" long, 16d nails are 0.162" dia. x 3-1/2" long.
- Load tables address hanger/header/fastener limitations only. Joist limitations must be determined for each installation.**

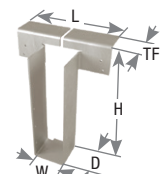

Continued on next page

Joist Size (in)	MiTek Stock No.	Ref. No.	Web Stiff Req'd	Ga	Dimensions (in)					Fastener Schedule ⁵					Allowable Loads Header Type (Lbs.) ^{1,3}							Code Ref.
					W	H	D	L	TF	Header		Joist			Download 100%					Uplift ²		
										Top Qty	Face Qty	Type	Qty	Type	LVL	PSL	LSL	SPF	DF I-Joist ⁴		DF/SP	
2-11/16 x 9-1/4	PHXU27925	--	--	7	2-3/4	9-1/4	3-1/4	10	2-1/2	4	4	16d	6	10d x 1-1/2	5370	5370	5370	4120	--	5370	870	IBC, FL, LA
	HLBH27925	--	x	7	2-3/4	9-1/4	6	12	2-3/4	3	12	NA16D-RS	6	10d x 1-1/2	10045	10045	10045	6900	--	10045	1115	
2-11/16 x 9-1/2	PHXU2795	--	--	7	2-3/4	9-1/2	3-1/4	10	2-1/2	4	4	16d	6	10d x 1-1/2	5370	5370	5370	4120	--	5370	870	
	HLBH2795	--	x	7	2-3/4	9-1/2	6	12	2-3/4	3	12	NA16D-RS	6	10d x 1-1/2	10045	10045	10045	6900	--	10045	1115	
2-11/16 x 11-1/4	PHXU27112	--	--	7	2-3/4	11-1/4	3-1/4	10	2-1/2	4	4	16d	6	10d x 1-1/2	5370	5370	5370	4120	--	5370	870	
	HLBH27112	--	x	7	2-3/4	11-1/4	6	12	2-3/4	3	12	NA16D-RS	6	10d x 1-1/2	10045	10045	10045	6900	--	10045	1115	
2-11/16 x 11-7/8	PHXU27118	--	--	7	2-3/4	11-7/8	3-1/4	10	2-1/2	4	4	16d	6	10d x 1-1/2	5370	5370	5370	4120	--	5370	870	
	HLBH27118	--	x	7	2-3/4	11-7/8	6	12	2-3/4	3	12	NA16D-RS	6	10d x 1-1/2	10045	10045	10045	6900	--	10045	1115	
2-11/16 x 14	PHXU2714	--	--	7	2-3/4	14	3-1/4	10	2-1/2	4	4	16d	6	10d x 1-1/2	5370	5370	5370	4120	--	5370	870	
	HLBH2714	--	x	7	2-3/4	14	6	12	2-3/4	3	12	NA16D-RS	6	10d x 1-1/2	10045	10045	10045	6900	--	10045	1115	
2-11/16 x 16	PHXU2716	--	--	7	2-3/4	16	3-1/4	10	2-1/2	4	4	16d	6	10d x 1-1/2	5370	5370	5370	4120	--	5370	870	
	HLBH2716	--	x	7	2-3/4	16	6	12	2-3/4	3	12	NA16D-RS	6	10d x 1-1/2	10045	10045	10045	6900	--	10045	1115	
3 x 9-1/4	BPH31925	--	x	12	3-1/8	9-1/4	3	--	2-1/8	4	6	16d	4	10d	3055	3055	3055	2345	--	3055	850	
	PHXU31925	--	x	7	3-1/8	9-1/4	3-1/4	10	2-1/2	4	4	16d	6	10d x 1-1/2	5370	5370	5370	4120	--	5370	870	
3 x 9-1/2	THO15950-2	--	x	16	3-1/16	9-1/2	2-3/8	--	1-1/2	4	6	16d	6	10d	2525	2525	2525	1905	2525	2525	1135	
	BPH3195	--	x	12	3-1/8	9-1/2	3	--	2-7/16	4	6	16d	4	10d	3055	3055	3055	2345	--	3055	850	
	PHXU3195	--	x	7	3-1/8	9-1/2	3-1/4	10	2-1/2	4	4	16d	6	10d x 1-1/2	5370	5370	5370	4120	--	5370	870	
3 x 11-1/4	BPH31112	--	x	12	3-1/8	11-1/4	3	--	2-1/8	4	6	16d	4	10d	3055	3055	3055	2345	--	3055	850	
	PHXU31112	--	x	7	3-1/8	11-1/4	3-1/4	10	2-1/2	4	4	16d	6	10d x 1-1/2	5370	5370	5370	4120	--	5370	870	
3 x 11-7/8	THO15118-2	--	x	16	3-1/16	11-7/8	2-3/8	--	1-1/2	4	6	16d	6	10d	2525	2525	2525	1890	2525	2525	1135	
	BPH31118	--	x	12	3-1/8	11-7/8	3	--	2-1/8	4	6	16d	4	10d	3055	3055	3055	2345	--	3055	850	
3 x 14	PHXU31118	--	x	7	3-1/8	11-7/8	3-1/4	10	2-1/2	4	4	16d	6	10d x 1-1/2	5370	5370	5370	4120	--	5370	870	
	BPH3114	--	x	12	3-1/8	14	3	--	2-3/32	4	6	16d	4	10d	3055	3055	3055	2345	--	3055	850	
3-1/2 x 7-1/4	PHXU3114	--	x	7	3-1/8	14	3-1/4	10	2-1/2	4	4	16d	6	10d x 1-1/2	5370	5370	5370	4120	--	5370	870	
	PHXU35725	--	x	7	3-9/16	7-1/4	3-1/4	10	2-1/2	4	4	16d	6	10d	5910	5910	5910	4535	--	5910	1120	
3-1/2 x 9-1/4	THO35925	ITS3.56/9.25	--	16	3-9/16	9-1/4	2-3/8	--	2-1/2	4	6	10d	2	10d x 1-1/2	2370	2370	2370	2370	2050	2370	230	
	BPH35925	BA3.56/9.25	x	12	3-9/16	9-1/4	2-3/8	--	2-3/8	4	6	16d	4	10d	3100	3100	3100	2380	--	3100	850	
	HBPH35925	HB3.56/9.25	x	10	3-9/16	9-1/4	3-1/2	--	3	6	16	16d	10	16d	6310	6310	6310	5035	--	6310	2705	
	PHM35925	WP3.56 H=9.25	x	7/10	3-5/8	9-1/4	2-1/2	7	3	2	--	16d	2	10d	3335	3335	3335	2535	--	3335	--	
	PHXU35925	HWP3.56 H=9.25	x	7	3-9/16	9-1/4	3-1/4	10	2-1/2	4	4	16d	6	10d	5910	5910	5910	4535	--	5910	1120	
	HLBH35925	HGLTV3.56/9.25	x	7	3-5/8	9-1/4	6	12	3-1/8	3	12	NA16D-RS	6	16d	10045	10045	10045	7705	--	10045	1420	
3-1/2 x 9-3/8	THO35938	--	--	16	3-9/16	9-3/8	2-3/8	--	2-4/7	4	6	10d	2	10d x 1-1/2	2370	2370	2370	2215	2050	2370	230	
3-1/2 x 9-1/2	THO35950	ITS3.56/9.5	--	16	3-9/16	9-1/2	2-3/8	--	2-7/16	4	6	10d	2	10d x 1-1/2	2370	2370	2370	2370	2050	2370	230	
	THO17950-2	MIT49.5	x	16	3-9/16	9-1/2	2-3/8	--	1-9/16	4	6	16d	6	10d	2920	2920	2920	1955	2630	2630	1135	
	BPH3595	BA3.56/9.5	x	12	3-9/16	9-1/2	2-3/8	--	2-3/8	4	6	16d	4	10d	3100	3100	3100	2380	--	3100	850	
	HBPH3595	HB3.56/9.5	x	10	3-9/16	9-1/2	3-1/2	--	3	6	16	16d	10	16d	6310	6310	6310	5035	--	6310	2705	
	PHM3595	WP3.56 H=9.5	x	7/10	3-5/8	9-1/2	2-1/2	7	3	2	--	16d	2	10d	3335	3335	3335	2535	--	3335	--	
	PHXU3595	HWP3.56 H=9.5	x	7	3-9/16	9-1/2	3-1/4	10	2-1/2	4	4	16d	6	10d	5910	5910	5910	4535	--	5910	1120	
	HLBH3595	HGLTV3.59	x	7	3-5/8	9-1/2	6	12	3-1/8	3	12	NA16D-RS	6	16d	10045	10045	10045	7705	--	10045	1420	

- When I-joist is used as a header, all header nails must be 10d (0.148") x 1-1/2.
 - Uplift loads have been increased 60% for wind or seismic loads; no further increase shall be permitted
 - Some listed loads may be increased for short-term loading. Refer to MiTek code evaluation reports for details.
 - When I-Joists with flanges less than 1-1/2" thick are used as headers, the reduction factor for 1-1/4" flange is 0.69 and 0.84 for 1-3/8" flange.
 - NAILS:** 10d x 1-1/2 nails are 0.148" dia. x 1-1/2" long, 10d nails are 0.148" dia. x 3" long, NA16D-RS nails are 0.148" x 3-1/2" long, 16d nails are 0.162" dia. x 3-1/2" long.
- Load tables address hanger/header/fastener limitations only. Joist limitations must be determined for each installation.**

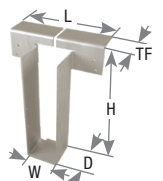

Continued on next page

Joist Size (in)	MiTek Stock No.	Ref. No.	Web Stiff Req'd	Ga	Dimensions (in)					Fastener Schedule ⁵					Allowable Loads Header Type (Lbs.) ^{1,3}							Code Ref.
					W	H	D	L	TF	Header		Joist			Download 100%				Uplift ² 160%			
										Top Qty	Face Qty	Type	Qty	Type	LVL	PSL	LSL	SPF		DF I-Joist ⁴	DF/SP	
3-1/2 x 11-1/4	THO35112	--	--	16	3-9/16	11-1/4	2-3/8	--	2-1/2	4	6	10d	2	10d x 1-1/2	2370	2370	2370	2370	2050	2370	230	
	BPH35112	BA3.56/11.25	x	12	3-9/16	11-1/4	2-3/8	--	2-3/8	4	6	16d	4	10d	3100	3100	3100	2380	--	3100	850	
	HBPH35112	HB3.56/11.25	x	10	3-9/16	11-1/4	3-1/2	--	3	6	16	16d	10	16d	6310	6310	6310	5035	--	6310	2705	
	PHXU35112	WP3.56 H=11.25, HWP3.56 H=11.25	x	7	3-9/16	11-1/4	3-1/4	10	2-1/2	4	4	16d	6	10d	5910	5910	5910	4535	--	5910	1120	
	HLBH35112	HGLTV3.56/11.25	x	7	3-5/8	11-1/4	6	12	3-1/8	3	12	NA16D-RS	6	16d	10045	10045	10045	7705	--	10045	1420	
3-1/2 x 11-7/8	THO35118	ITS3.56/11.88	--	18	3-9/16	11-7/8	2-3/8	--	2-1/2	4	6	10d	2	10d x 1-1/2	2525	2525	2525	2265	2050	2525	230	
	THO17118-2	MIT411.88	x	16	3-9/16	11-7/8	2-3/8	--	1-9/16	4	6	16d	6	10d	2740	2860	2920	1815	2430	2430	1135	
	BPH35118	BA3.56/11.88	x	12	3-9/16	11-7/8	2-3/8	--	2-3/8	4	6	16d	4	10d	3100	3100	3100	2380	--	3100	850	
	HBPH35118	HB3.56/11.88	x	10	3-9/16	11-7/8	3-1/2	--	3	6	16	16d	10	16d	6310	6310	6310	5035	--	6310	2705	
	PHM35118	WP3.56 H=11.875	x	7/10	3-5/8	11-7/8	2-1/2	7	3	2	--	16d	2	10d	3335	3335	3335	2535	--	3335	--	
	PHXU35118	HWP3.56 H=11.875, HWP3.56 H=11.875	x	7	3-9/16	11-7/8	3-1/4	10	2-1/2	4	4	16d	6	10d	5910	5910	5910	4535	--	5910	1120	
HLBH35118	HGLT4 H=11.875, HGLTV3.511	x	7	3-5/8	11-7/8	6	12	3-1/8	3	12	NA16D-RS	6	16d	10045	10045	10045	7705	--	10045	1420		
3-1/2 x 12	THO35120	--	--	18	3-9/16	12	2-3/8	--	2-1/2	4	6	10d	2	10d x 1-1/2	2525	2525	2525	2265	2050	2525	230	
	BPH3512	--	x	12	3-9/16	12	2-3/4	--	3	4	6	16d	6	10d	3050	3050	3050	2345	--	3050	1140	
	HBPH3512	HB3.56/12	x	10	3-9/16	12	3-1/2	--	3	6	16	16d	10	16d	6310	6310	6310	5035	--	6310	2705	
	PHXU3512	--	x	7	3-9/16	12	3-1/4	10	2-1/2	4	4	16d	6	10d	5910	5910	5910	4535	--	5910	1120	
	HLBH3512	HGLTV3.512	x	7	3-5/8	12	6	12	3-1/8	3	12	NA16D-RS	6	16d	10045	10045	10045	7705	--	10045	1420	
3-1/2 x 13	THO35130	--	--	18	3-9/16	13	2-3/8	--	2-1/2	4	6	10d	2	10d x 1-1/2	2525	2525	2525	2265	2050	2525	230	
3-1/2 x 14	THO35140	ITS3.56/14	--	18	3-9/16	14	2-3/8	--	2-1/2	4	8	10d	2	10d x 1-1/2	2400	2400	2400	1835	2400	2400	230	
	TFI414	MIT414	--	16	3-9/16	14	2-1/2	--	2-1/8	4	2	16d	2	10d x 1-1/2	2715	2715	2715	2075	--	2715	215	
	BPH3514	BA3.56/14	x	12	3-9/16	14	2-3/4	--	3	4	6	16d	6	10d	3050	3050	3050	2345	--	3050	1140	
	HBPH3514	HB3.56/14	x	10	3-9/16	14	3-1/2	--	3	6	16	16d	10	16d	6310	6310	6310	5035	--	6310	2705	
	PHM3514	WP3.56 H=14	x	7/10	3-5/8	14	2-1/2	7	3	2	--	16d	2	10d	3335	3335	3335	2535	--	3335	--	
	PHXU3514	HWP3.56 H=14, HWP3.56 H=14	x	7	3-9/16	14	3-1/4	10	2-1/2	4	4	16d	6	10d	5910	5910	5910	4535	--	5910	1120	
HLBH3514	HGLT4 H=14, HGLTV3.514	x	7	3-5/8	14	6	12	3-1/8	3	12	NA16D-RS	6	16d	10045	10045	10045	7705	--	10045	1420		
3-1/2 x 16	THO35160	ITS3.56/16	--	18	3-9/16	16	2-3/8	--	2-1/2	4	8	10d	2	10d x 1-1/2	2400	2400	2400	1835	2400	2400	230	
	TFI416	MIT416	--	16	3-9/16	16	2-1/2	--	2-1/8	4	2	16d	2	10d x 1-1/2	2715	2715	2715	2075	--	2715	215	
	BPH3516	BA3.56/16	x	12	3-9/16	16	2-3/4	--	3	4	6	16d	6	10d	3050	3050	3050	2345	--	3050	1140	
	HBPH3516	HB3.56/16	x	10	3-9/16	16	3-1/2	--	3	6	16	16d	10	16d	6310	6310	6310	5035	--	6310	2705	
	PHM3516	WP3.56 H=16	x	7/10	3-5/8	16	2-1/2	7	3	2	--	16d	2	10d	3335	3335	3335	2535	--	3335	--	
	PHXU3516	HWP3.56 H=16, HWP3.56 H=16	x	7	3-9/16	16	3-1/4	10	2-1/2	4	4	16d	6	10d	5910	5910	5910	4535	--	5910	1120	
	HLBH3516	HGLTV4 H=16, HGLTV3.516	x	7	3-5/8	16	6	12	3-1/8	3	12	NA16D-RS	6	16d	10045	10045	10045	7705	--	10045	1420	
3-1/2 x 18	TFI418	HIT418, MIT418	--	16	3-9/16	18	2-1/2	--	2-1/8	4	2	16d	2	10d x 1-1/2	2715	2715	2715	2075	--	2715	215	
	BPH3518	BA3.56/18	x	12	3-9/16	18	2-3/4	--	3	4	6	16d	6	10d	3050	3050	3050	2345	--	3050	1140	
	HBPH3518	HB3.56/18	x	10	3-9/16	18	3-1/2	--	3	6	16	16d	10	16d	6310	6310	6310	5035	--	6310	2705	
	PHM3518	WP3.56 H=18	x	7/10	3-5/8	18	2-1/2	7	3	2	--	16d	2	10d	3335	3335	3335	2535	--	3335	--	
	PHXU3518	HWP3.56 H=18, HWP3.56 H=18	x	7	3-9/16	18	3-1/4	10	2-1/2	4	4	16d	6	10d	5910	5910	5910	4535	--	5910	1120	
	HLBH3518	HGLTV4 H=18, HGLTV3.518	x	7	3-5/8	18	6	12	3-1/8	3	12	NA16D-RS	6	16d	10045	10045	10045	7705	--	10045	1420	

IBC, FL, LA

Copyright © 2022 MiTek Industries, Inc. All Rights Reserved

- 1) When I-joist is used as a header, all header nails must be 10d (0.148") x 1-1/2.
- 2) Uplift loads have been increased 60% for wind or seismic loads; no further increase shall be permitted.
- 3) Some listed loads may be increased for short-term loading. Refer to MiTek code evaluation reports for details.
- 4) When I-Joists with flanges less than 1-1/2" thick are used as headers, the reduction factor for 1-1/4" flange is 0.69 and 0.84 for 1-3/8" flange.
- 5) NAILS: 10d x 1-1/2 nails are 0.148" dia. x 1-1/2" long, 10d nails are 0.148" dia. x 3" long, NA16D-RS nails are 0.148" x 3-1/2" long, 16d nails are 0.162" dia. x 3-1/2" long. Load tables address hanger/header/fastener limitations only. Joist limitations must be determined for each installation.

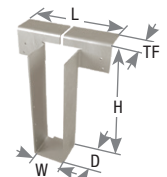

Continued on next page

Joist Size (in)	MiTek Stock No.	Ref. No.	Web Stiff Req'd	Ga	Dimensions (in)					Fastener Schedule ⁵					Allowable Loads Header Type (Lbs.) ^{1,3}							Code Ref.
					W	H	D	L	TF	Header			Joist		Download 100%					Uplift ²		
										Top Qty	Face Qty	Type	Qty	Type	LVL	PSL	LSL	SPF	DF I-Joist ⁴		DF/SP	
3-1/2 x 20	TFI420	HIT420, MIT420	--	16	3-9/16	20	2-1/2	--	2-1/8	4	2	16d	2	10d x 1-1/2	2715	2715	2715	2075	--	2715	215	IBC, FL, LA
	BPH3520	BA3.56/20	x	12	3-9/16	20	2-3/4	--	3	4	6	16d	6	10d	3050	3050	3050	2345	--	3050	1140	
	HBPH3520	HB3.56/20	x	10	3-9/16	20	3-1/2	--	3	6	16	16d	10	16d	6310	6310	6310	5035	--	6310	2705	
	PHM3520	WP3.56 H=20	x	7/10	3-5/8	20	2-1/2	7	3	2	--	16d	2	10d	3335	3335	3335	2535	--	3335	--	
	PHXU3520	HWP3.56 H=20, HWP3.56 H=20	x	7	3-9/16	20	3-1/4	10	2-1/2	4	4	16d	6	10d	5910	5910	5910	4535	--	5910	1120	
	HLBH3520	HGLT4 H=20	x	7	3-5/8	20	6	12	3-1/8	3	12	NA16D-RS	6	16d	10045	10045	10045	7705	--	10045	1420	
3-1/2 x 22	TFI422	HIT422	--	16	3-9/16	22	2-1/2	--	2-1/8	4	6	16d	2	10d x 1-1/2	2820	2820	2820	2480	--	2820	215	IBC, FL, LA
	BPH3522	BA3.56/22	x	12	3-9/16	22	2-3/4	--	3	4	6	16d	6	10d	3050	3050	3050	2345	--	3050	1140	
	HBPH3522	HB3.56/22	x	10	3-9/16	22	3-1/2	--	3	6	16	16d	10	16d	6310	6310	6310	5035	--	6310	2705	
	PHM3522	WP3.56 H=22	x	7/10	3-5/8	22	2-1/2	7	3	2	--	16d	2	10d	3335	3335	3335	2535	--	3335	--	
	PHXU3522	HWP3.56 H=22, HWP3.56 H=22	x	7	3-9/16	22	3-1/4	10	2-1/2	4	4	16d	6	10d	5910	5910	5910	4535	--	5910	1120	
3-1/2 x 24	TFI424	HIT424	--	16	3-9/16	24	2-1/2	--	2-1/8	4	6	16d	2	10d x 1-1/2	2820	2820	2820	2480	--	2820	215	IBC, FL, LA
	BPH3524	BA3.56/24	x	12	3-9/16	24	2-3/4	--	3	4	6	16d	6	10d	3050	3050	3050	2345	--	3050	1140	
	HBPH3524	HB3.56/24	x	10	3-9/16	24	3-1/2	--	3	6	16	16d	10	16d	6310	6310	6310	5035	--	6310	2705	
	PHM3524	WP3.56 H=24	x	7/10	3-5/8	24	2-1/2	7	3	2	--	16d	2	10d	3335	3335	3335	2535	--	3335	--	
	PHXU3524	HWP3.56 H=24, HWP3.56 H=24	x	7	3-9/16	24	3-1/4	10	2-1/2	4	4	16d	6	10d	5910	5910	5910	4535	--	5910	1120	
3-1/2 x 26	TFI426	--	--	16	3-9/16	26	2-1/2	--	2-1/8	4	6	16d	2	10d x 1-1/2	2820	2820	2820	2480	--	2820	215	IBC, FL, LA
	BPH3526	BA3.56/26	x	12	3-9/16	26	2-3/4	--	3	4	6	16d	6	10d	3050	3050	3050	2345	--	3050	1140	
	HBPH3526	HB3.56/26	x	10	3-9/16	26	3-1/2	--	3	6	16	16d	10	16d	6310	6310	6310	5035	--	6310	2705	
	PHM3526	WP3.56 H=26	x	7/10	3-5/8	26	2-1/2	7	3	2	--	16d	2	10d	3335	3335	3335	2535	--	3335	--	
	PHXU3526	HWP3.56 H=26, HWP3.56 H=26	x	7	3-9/16	26	3-1/4	10	2-1/2	4	4	16d	6	10d	5910	5910	5910	4535	--	5910	1120	
3-1/2 x 28	BPH3528	BA3.56/28	x	12	3-9/16	28	2-3/4	--	3	4	6	16d	6	10d	3050	3050	3050	2345	--	3050	1140	IBC, FL, LA
	HBPH3528	HB3.56/28	x	10	3-9/16	28	3-1/2	--	3	6	16	16d	10	16d	6310	6310	6310	5035	--	6310	2705	
	PHM3528	WP3.56 H=28	x	7/10	3-5/8	28	2-1/2	7	3	2	--	16d	2	10d	3335	3335	3335	2535	--	3335	--	
	PHXU3528	HWP3.56 H=28, HWP3.56 H=28	x	7	3-9/16	28	3-1/4	10	2-1/2	4	4	16d	6	10d	5910	5910	5910	4535	--	5910	1120	
3-1/2 x 30	BPH3530	BA3.56/30	x	12	3-9/16	30	2-3/4	--	3	4	6	16d	6	10d	3050	3050	3050	2345	--	3050	1140	IBC, FL, LA
	HBPH3530	HB3.56/30	x	10	3-9/16	30	3-1/2	--	3	6	16	16d	10	16d	6310	6310	6310	5035	--	6310	2705	
	PHM3530	WP3.56 H=30	x	7/10	3-5/8	30	2-1/2	7	3	2	--	16d	2	10d	3335	3335	3335	2535	--	3335	--	
	PHXU3530	HWP3.56 H=30, HWP3.56 H=30	x	7	3-9/16	30	3-1/4	10	2-1/2	4	4	16d	6	10d	5910	5910	5910	4535	--	5910	1120	
3-1/2 x 32	BPH3532	--	x	12	3-9/16	32	2-3/4	--	3	4	6	16d	6	10d	3050	3050	3050	2345	--	3050	1140	IBC, FL, LA
	PHM3532	--	x	7/10	3-5/8	32	2-1/2	7	3	2	--	16d	2	10d	3335	3335	3335	2535	--	3335	--	
	PHXU3532	--	x	7	3-9/16	32	3-1/4	10	2-1/2	4	4	16d	6	10d	5910	5910	5910	4535	--	5910	1120	
4 - 4-3/16 x 9-1/2	THO20950-2	MIT4.12/9.5, BA4.12/9.5	x	16	4-3/16	9-1/2	3	--	2	4	6	16d	6	10d	2920	2920	2920	2245	2630	2920	1135	IBC, FL, LA
	PHM4295	WP4.12 H=9.5	x	7/10	4-3/16	9-1/2	2-1/2	7	3	2	--	16d	2	10d	3265	3265	3265	2480	--	3265	--	
4 - 4-3/16 x 11-7/8	THO20118-2	MIT4.12/11.88, BA4.12/11.88	x	16	4-3/16	11-7/8	3	--	2	4	6	16d	6	10d	2920	2920	2920	2245	2630	2920	1135	IBC, FL, LA
	PHM42118	WP4.12 H=11.875	x	7/10	4-3/16	11-7/8	2-1/2	7	3	2	--	16d	2	10d	3265	3265	3265	2480	--	3265	--	
4 - 4-3/16 x 14	THO20140-2	BA4.12/14	x	12	4-3/16	14	3	--	1-15/16	4	6	16d	6	10d	3640	3640	3640	2800	2630	3640	1145	IBC, FL, LA
	PHM4214	WP4.12 H=14	x	7/10	4-3/16	14	2-1/2	7	3	2	--	16d	2	10d	3265	3265	3265	2480	--	3265	--	

- When I-joist is used as a header, all header nails must be 10d (0.148") x 1-1/2".
 - Uplift loads have been increased 60% for wind or seismic loads; no further increase shall be permitted.
 - Some listed loads may be increased for short-term loading. Refer to MiTek code evaluation reports for details.
 - When I-Joists with flanges less than 1-1/2" thick are used as headers, the reduction factor for 1-1/4" flange is 0.69 and 0.84 for 1-3/8" flange.
 - NAILS:** 10d x 1-1/2" nails are 0.148" dia. x 1-1/2" long, 10d nails are 0.148" dia. x 3" long, 16d nails are 0.162" dia. x 3-1/2" long.
- Load tables address hanger/header/fastener limitations only. Joist limitations must be determined for each installation.**

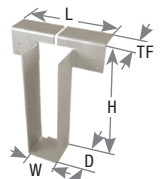

Continued on next page

Joist Size (in)	MiTek Stock No.	Ref. No.	Web Stiff Req'd	Ga	Dimensions (in)					Fastener Schedule ⁵					Allowable Loads Header Type (Lbs.) ^{1,3}							Code Ref.
					W	H	D	L	TF	Header		Joist			Download 100%					Uplift ²		
										Top Qty	Face Qty	Type	Qty	Type	LVL	PSL	LSL	SPF	DF I-Joist ⁴	DF/SP 160%	DF/SP	
4 - 4-3/16 x 16	THO20160-2	BA4.12/16	x	12	4-3/16	16	3	--	1-15/16	4	6	16d	6	10d	3640	3640	3640	2800	2630	3640	1145	IBC, FL, LA
	PHM4216	WP4.12 H=16	x	7/10	4-3/16	16	2-1/2	7	3	2	--	16d	2	10d	3265	3265	3265	2480	--	3265	--	
4-1/2 - 4-5/8 x 9-1/2	THO23950-2	MIT4.28/9.5, BA4.28/9.5	x	12	4-3/4	9-1/2	3	--	2	4	6	16d	6	10d	3640	3640	3640	2790	2630	3640	1145	
	PHM2395-2	WP4.28X H=9.5	x	7/10	4-3/4	9-1/2	2-1/2	7	3	2	--	16d	2	10d	3265	3265	3265	2480	--	3265	--	
4-1/2 - 4-5/8 x 11-7/8	THO23118-2	MIT4.28/11.88, BA4.28/11.88	x	12	4-3/4	11-7/8	3	--	2-1/8	4	6	16d	6	10d	3640	3640	3640	2795	2630	3640	1145	
	PHM23118-2	WP4.28X H=11.875	x	7/10	4-3/4	11-7/8	2-1/2	7	3	2	--	16d	2	10d	3265	3265	3265	2480	--	3265	--	
4-1/2 - 4-5/8 x 14	THO23140-2	MIT4.28/14, BA4.28/14	x	12	4-3/4	14	3	--	2-1/8	4	8	16d	6	10d	4420	4420	4420	3390	2630	4420	1145	
4-1/2 - 4-5/8 x 16	THO23160-2	BA4.28/16	x	12	4-3/4	16	3	--	2-1/8	4	8	16d	6	10d	4420	4420	4420	3390	2630	4420	1145	
	PHM2316-2	WP4.28X H=16	x	7/10	4-3/4	16	2-1/2	7	3	2	--	16d	2	10d	3265	3265	3265	2480	--	3265	--	
4-1/2 - 4-5/8 x 18	THO23180-2	BA4.75/18	x	12	4-3/4	18	3	--	2-1/8	4	10	16d	6	10d	5660	5760	5760	3720	2630	5000	1145	
	PHM2318-2	WP4.75 H=18	x	7/10	4-3/4	18	2-1/2	7	3	2	--	16d	2	10d	3265	3265	3265	2480	--	3265	--	
4-1/2 - 4-5/8 x 20	THO23200-2	BA4.75/20	x	12	4-3/4	20	3	--	2-1/8	4	10	16d	6	10d	5660	5760	5760	3720	2630	5000	1145	
	PHM2320-2	WP4.75 H=20	x	7/10	4-3/4	20	2-1/2	7	3	2	--	16d	2	10d	3265	3265	3265	2480	--	3265	--	
5 x 9-1/4	THO25925-2	BA5.12/9.25	x	12	5-1/8	9-1/4	3	--	2-11/16	4	6	16d	6	10d	3640	3640	3640	2790	2630	3640	1145	
5 x 9-1/2	THO25950-2	MIT39.5-2	x	12	5-1/8	9-1/2	3	--	2-1/8	4	6	16d	6	10d	3640	3640	3640	2790	2630	3640	1145	
	PHM2595-2	WP5.12 H=9.5	x	7/10	5-1/8	9-1/2	2-1/2	7	3	2	--	16d	2	10d	3265	3265	3265	2480	--	3265	--	
5 x 11-1/4	THO25112-2	--	x	12	5-1/8	11-1/4	3	--	2-1/8	4	6	16d	6	10d	3640	3640	3640	2790	2630	3640	1145	
5 x 11-7/8	THO25118-2	MIT311.88-2, BA5.12/11.88, WP5.12 H=11.875	x	12	5-1/8	11-7/8	3	--	2-1/8	4	6	16d	6	10d	3640	3640	3640	2790	2630	3640	1145	
5 x 14	THO25140-2	MIT314-2, BA5.12/14	x	12	5-1/8	14	3	--	2-1/8	4	8	16d	6	10d	4420	4420	4420	3390	2630	4420	1145	
	PHM2514-2	WP5.12 H=14	x	7/10	5-1/8	14	2-1/2	7	3	2	--	16d	2	10d	3265	3265	3265	2480	--	3265	--	
5 x 16	THO25160-2	MIT5.12/16, BA5.12/16	x	12	5-1/8	16	3	--	2-1/8	4	8	16d	6	10d	4420	4420	4420	3390	2630	4420	1145	
	HBPH5116	HB5.12/16	x	10	5-1/8	16	3-1/2	--	3	6	16	16d	10	16d	6185	6185	6185	4910	--	6185	2705	
	PHM2516-2	WP5.12 H=16	x	7/10	5-1/8	16	2-1/2	7	3	2	--	16d	2	10d	3265	3265	3265	2480	--	3265	--	
5 x 18	THO25180-2	BA5.12/18	x	12	5-1/8	18	3	--	2-1/8	4	10	16d	6	10d	5660	5760	5760	3720	2630	5000	1145	
	HBPH5118	HB5.12/18	x	10	5-1/8	18	3-1/2	--	3	6	16	16d	10	16d	6185	6185	6185	4910	--	6185	2705	
	PHM2518-2	WP5.12 H=18	x	7/10	5-1/8	18	2-1/2	7	3	2	--	16d	2	10d	3265	3265	3265	2480	--	3265	--	
5 x 20	THO25200-2	BA5.12/20	x	12	5-1/8	20	3	--	2-1/8	4	10	16d	6	10d	5660	5760	5760	3720	2630	5000	1145	
	HBPH5120	HB5.12/20	x	10	5-1/8	20	3-1/2	--	3	6	16	16d	10	16d	6185	6185	6185	4910	--	6185	2705	
	PHM2520-2	WP5.12 H=20	x	7/10	5-1/8	20	2-1/2	7	3	2	--	16d	2	10d	3265	3265	3265	2480	--	3265	--	
5 x 22	HBPH5122	HB5.12/22	x	10	5-1/8	22	3-1/2	--	3	6	16	16d	10	16d	6185	6185	6185	4910	--	6185	2705	
	PHM2522-2	WP5.12 H=22	x	7/10	5-1/8	22	2-1/2	7	3	2	--	16d	2	10d	3265	3265	3265	2480	--	3265	--	
5 x 24	HBPH5124	HB5.12/24	x	10	5-1/8	24	3-1/2	--	3	6	16	16d	10	16d	6185	6185	6185	4910	--	6185	2705	
	PHM2524-2	WP5.12X H=24	x	7/10	5-1/8	24	2-1/2	7	3	2	--	16d	2	10d	3265	3265	3265	2480	--	3265	--	
5 x 26	HBPH5126	HB5.12/26	x	10	5-1/8	26	3-1/2	--	3	6	16	16d	10	16d	6185	6185	6185	4910	--	6185	2705	
	PHM2526-2	WP5.12 H=26	x	7/10	5-1/8	26	2-1/2	7	3	2	--	16d	2	10d	3265	3265	3265	2480	--	3265	--	
5 x 28	HBPH5128	HB5.12/28	x	10	5-1/8	28	3-1/2	--	3	6	16	16d	10	16d	6185	6185	6185	4910	--	6185	2705	
5 x 30	HBPH5130	--	x	10	5-1/8	30	3-1/2	--	3	6	16	16d	10	16d	6185	6185	6185	4910	--	6185	2705	
5-1/4 x 7-1/4	BPH55725	--	x	10	5-9/16	7-1/4	2-1/4	--	2-1/2	4	6	16d	6	10d	3065	3065	3065	2340	--	3065	850	
	HBPH55725	--	x	10	5-1/2	7-1/4	3-1/2	--	3	6	16	16d	10	16d	6185	6185	6185	4910	--	6185	2705	

- When I-joist is used as a header, all header nails must be 10d (0.148") x 1-1/2.
 - Uplift loads have been increased 60% for wind or seismic loads; no further increase shall be permitted
 - Some listed loads may be increased for short-term loading. Refer to MiTek code evaluation reports for details.
 - When I-Joists with flanges less than 1-1/2" thick are used as headers, the reduction factor for 1-1/4" flange is 0.69 and 0.84 for 1-3/8" flange.
 - NAILS:** 10d nails are 0.148" dia. x 3" long, NA16D-RS nails are 0.148" x 3-1/2" long, 16d nails are 0.162" dia. x 3-1/2" long.
- Load tables address hanger/header/fastener limitations only. Joist limitations must be determined for each installation.**

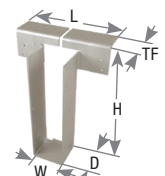

Continued on next page

Joist Size (in)	MiTek Stock No.	Ref. No.	Web Stiff Req'd	Ga	Dimensions (in)					Fastener Schedule ⁵				Allowable Loads Header Type (Lbs.) ^{1,3}							Code Ref.	
					W	H	D	L	TF	Header		Joist		Download 100%					Uplift ²			
										Top Qty	Face Qty	Type	Qty	Type	LVL	PSL	LSL	SPF		DF I-Joist ⁴		DF/SP
5-1/4 x 9-1/4	HBP55925	HB5.50/9.25	x	10	5-1/2	9-1/4	3-1/2	--	3	6	16	16d	10	16d	6185	6185	6185	4910	--	6185	2705	IBC, FL, LA
	PHXU55925	HWP5.37 H=9.25, HWP5.37 H=9.25	x	7	5-1/2	9-1/4	3-1/4	11-1/2	3	4	4	16d	6	10d	5910	5910	5910	4530	--	5910	1120	
	HLBH55925	HGLTV5.37 H=9.25	x	7	5-9/16	9-1/4	6	12	3-1/8	3	12	NA16D-RS	6	16d	10045	10045	10045	7680	--	10045	1580	
5-1/4 x 9-1/2	BPH5595	--	x	12	5-9/16	9-1/2	3	--	2-5/32	4	6	16d	4	10d	3065	3065	3065	2340	--	3065	850	
	HBP5595	HB5.50/9.5	x	10	5-1/2	9-1/2	3-1/2	--	3	6	16	16d	10	16d	6185	6185	6185	4910	--	6185	2705	
	PHM5595	--	x	7/10	5-5/8	9-1/2	2-1/2	7	3	2	--	16d	2	10d	3265	3265	3265	2480	--	3265	--	
	PHXU5595	HWP5.37 H=9.5, HWP5.37 H=9.5	x	7	5-1/2	9-1/2	3-1/4	11-1/2	2-1/2	4	4	16d	6	10d	5910	5910	5910	4530	--	5910	1120	
	HLBH5595	HGLTV5.37 H=9.5	x	7	5-9/16	9-1/2	6	12	3-1/8	3	12	NA16D-RS	6	16d	10045	10045	10045	7680	--	10045	1580	
5-1/4 x 11-1/4	HBP55112	HB5.50/11.25	x	10	5-1/2	11-1/4	3-1/2	--	3	6	16	16d	10	16d	6185	6185	6185	4910	--	6185	2705	
	PHXU55112	HWP5.37 H=11.25, HWP5.37 H=11.25	x	7	5-1/2	11-1/4	3-1/4	11-1/2	2-1/2	4	4	16d	6	10d	5910	5910	5910	4530	--	5910	1120	
	HLBH55112	HGLTV5.37 H=11.25	x	7	5-9/16	11-1/4	6	12	3-1/8	3	12	NA16D-RS	6	16d	10045	10045	10045	7680	--	10045	1580	
5-1/4 x 11-1/2	HLBH55115	--	x	7	5-9/16	11-1/2	6	12	3-1/8	3	12	NA16D-RS	6	16d	10045	10045	10045	7680	--	10045	1580	
5-1/4 x 11-7/8	BPH55118	--	x	12	5-9/16	11-7/8	3	--	2-1/32	4	6	16d	6	10d	3050	3050	3050	2340	--	3050	1275	
	HBP55118	HB5.50/11.88	x	10	5-1/2	11-7/8	3-1/2	--	3	6	16	16d	10	16d	6185	6185	6185	4910	--	6185	2705	
	PHM55118	--	x	7/10	5-5/8	11-7/8	2-1/2	7	3	2	--	16d	2	10d	3265	3265	3265	2480	--	3265	--	
	PHXU55118	HWP5.37 H=11.875, HWP5.37 H=11.875	x	7	5-1/2	11-7/8	3-1/4	11-1/2	2-1/2	4	4	16d	6	10d	5910	5910	5910	4530	--	5910	1120	
	HLBH55118	HGLTV5.37 H=11.875	x	7	5-9/16	11-7/8	6	12	3-1/8	3	12	NA16D-RS	6	16d	10045	10045	10045	7680	--	10045	1580	
5-1/4 x 12	HBP5512	--	x	10	5-1/2	12	3-1/2	--	3	6	16	16d	10	16d	6185	6185	6185	4910	--	6185	2705	
	PHXU5512	--	x	7	5-1/2	12	3-1/4	11-1/2	2-1/2	4	4	16d	6	10d	5910	5910	5910	4530	--	5910	1120	
	HLBH5512	--	x	7	5-9/16	12	6	12	3-1/8	3	12	NA16D-RS	6	16d	10045	10045	10045	7680	--	10045	1580	
5-1/4 x 14	BPH5514	--	x	12	5-9/16	14	2-1/2	--	2-1/32	4	6	16d	6	10d	3050	3050	3050	2340	--	3050	1275	
	HBP5514	HB5.50/14	x	10	5-1/2	14	3-1/2	--	3	6	16	16d	10	16d	6185	6185	6185	4910	--	6185	2705	
	PHM5514	--	x	7/10	5-5/8	14	2-1/2	7	3	2	--	16d	2	10d	3265	3265	3265	2480	--	3265	--	
	PHXU5514	HWP5.37 H=14, HWP5.37 H=14	x	7	5-1/2	14	3-1/4	11-1/2	2-1/2	4	4	16d	6	10d	5910	5910	5910	4530	--	5910	1120	
	HLBH5514	HGLTV5.37 H=14	x	7	5-9/16	14	6	12	3-1/8	3	12	NA16D-RS	6	16d	10045	10045	10045	7680	--	10045	1580	
5-1/4 x 16	BPH5516	--	x	12	5-9/16	16	2-1/2	--	2-1/32	4	6	16d	6	10d	3050	3050	3050	2340	--	3050	1275	
	HBP5516	HB5.50/16	x	10	5-1/2	16	3-1/2	--	3	6	16	16d	10	16d	6185	6185	6185	4910	--	6185	2705	
	PHM5516	--	x	7/10	5-5/8	16	2-1/2	7	3	2	--	16d	2	10d	3265	3265	3265	2480	--	3265	--	
	PHXU5516	HWP5.37 H=16, HWP5.37 H=16	x	7	5-1/2	16	3-1/4	11-1/2	2-1/2	4	4	16d	6	10d	5910	5910	5910	4530	--	5910	1120	
	HLBH5516	HGLTV5.37 H=16	x	7	5-9/16	16	6	12	3-1/8	3	12	NA16D-RS	6	16d	10045	10045	10045	7680	--	10045	1580	
5-1/4 x 18	BPH5518	--	x	12	5-9/16	18	2-1/2	--	2-1/32	4	6	16d	6	10d	3050	3050	3050	2340	--	3050	1275	
	HBP5518	HB5.50/18	x	10	5-1/2	18	3-1/2	--	3	6	16	16d	10	16d	6185	6185	6185	4910	--	6185	2705	
	PHM5518	--	x	7/10	5-5/8	18	2-1/2	7	3	2	--	16d	2	10d	3265	3265	3265	2480	--	3265	--	
	PHXU5518	HWP5.37 H=18	x	7	5-1/2	18	3-1/4	11-1/2	2-1/2	4	4	16d	6	10d	5910	5910	5910	4530	--	5910	1120	
	HLBH5518	HGLTV5.37 H=18	x	7	5-9/16	18	6	12	3-1/8	3	12	NA16D-RS	6	16d	10045	10045	10045	7680	--	10045	1580	

1) When I-joist is used as a header, all header nails must be 10d (0.148") x 1-1/2.
 2) Uplift loads have been increased 60% for wind or seismic loads; no further increase shall be permitted
 3) Some listed loads may be increased for short-term loading. Refer to MiTek code evaluation reports for details.
 4) When I-Joists with flanges less than 1-1/2" thick are used as headers, the reduction factor for 1-1/4" flange is 0.69 and 0.84 for 1-3/8" flange.
 5) **NAILS:** 10d nails are 0.148" dia. x 3" long, NA16D-RS nails are 0.148" x 3-1/2" long, 16d nails are 0.162" dia. x 3-1/2" long.
Load tables address hanger/header/fastener limitations only. Joist limitations must be determined for each installation.

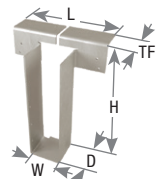

Continued on next page

Joist Size (in)	MiTek Stock No.	Ref. No.	Web Stiff Req'd	Ga	Dimensions (in)					Fastener Schedule ⁵					Allowable Loads Header Type (Lbs.) ^{1,3}							Code Ref.
					W	H	D	L	TF	Header			Joist		Download 100%					Uplift ² DF/SP 160%		
										Top Qty	Face Qty	Type	Qty	Type	LVL	PSL	LSL	SPF	DF I-Joist ⁴		DF/SP	
5-1/4 x 20	HBPH5520	HB5.50/20	x	10	5-1/2	20	3-1/2	--	3	6	16	16d	10	16d	6185	6185	6185	4910	--	6185	2705	IBC, FL, LA
	PHXU5520	HWP5.37 H=20	x	7	5-1/2	20	3-1/4	11-1/2	2-1/2	4	4	16d	6	10d	5910	5910	5910	4530	--	5910	1120	
	HLBH5520	HGLTV5.37 H=20	x	7	5-9/16	20	6	12	3-1/8	3	12	NA16D-RS	6	16d	10045	10045	10045	7680	--	10045	1580	
7 x 7-1/4	PHXU71725	--	x	7	7-1/8	7-1/4	3-1/4	13-1/8	2-1/2	4	4	16d	6	10d	5910	5910	5910	4525	--	5910	1120	
7 x 9-1/4	BPH71925	--	x	12	7-1/8	9-1/4	3	--	2-3/8	4	6	16d	6	10d	3100	3100	3100	2370	--	3100	1275	
	HBPH71925	--	x	10	7-1/8	9-1/4	3-1/2	--	3	6	16	16d	10	16d	6185	6185	6185	4895	--	6185	2705	
	PHM35925-2	--	x	7/10	7-1/8	9-1/4	2-1/2	10	3	2	--	16d	2	10d	3390	3390	3390	2580	--	3390	--	
	PHXU71925	--	x	7	7-1/8	9-1/4	3-1/4	13-1/8	2-1/2	4	4	16d	6	10d	5910	5910	5910	4525	--	5910	1120	
	HLBH71925	--	x	7	7-1/8	9-1/4	6	12	3-1/8	3	12	NA16D-RS	6	16d	10045	10045	10045	7670	--	10045	1580	
7 x 9-1/2	BPH7195	--	x	12	7-1/8	9-1/2	3	--	2-3/8	4	6	16d	6	10d	3100	3100	3100	2370	--	3100	1275	
	HBPH7195	HB7.12/9.5	x	10	7-1/8	9-1/2	3-1/2	--	3	6	16	16d	10	16d	6185	6185	6185	4895	--	6185	2705	
	PHM3595-2	--	x	7/10	7-1/8	9-1/2	2-1/2	10	3	2	--	16d	2	10d	3390	3390	3390	2580	--	3390	--	
	PHXU7195	HWP7.12 H=9.5	x	7	7-1/8	9-1/2	3-1/4	13-1/8	2-1/2	4	4	16d	6	10d	5910	5910	5910	4525	--	5910	1120	
	HLBH7195	--	x	7	7-1/8	9-1/2	6	12	3-1/8	3	12	NA16D-RS	6	16d	10045	10045	10045	7670	--	10045	1580	
7 x 11-1/4	BPH71112	--	x	12	7-1/8	11-1/4	3	--	2-3/16	4	6	16d	6	10d	3075	3075	3075	2350	--	3075	1275	
	HBPH71112	HB7.12/11.25	x	10	7-1/8	11-1/4	3-1/2	--	3	6	16	16d	10	16d	6185	6185	6185	4895	--	6185	2705	
	PHXU71112	--	x	7	7-1/8	11-1/4	3-1/4	13-1/8	2-1/2	4	4	16d	6	10d	5910	5910	5910	4525	--	5910	1120	
	HLBH71112	--	x	7	7-1/8	11-1/4	6	12	3-1/8	3	12	NA16D-RS	6	16d	10045	10045	10045	7670	--	10045	1580	
7 x 11-7/8	BPH71118	--	x	12	7-1/8	11-7/8	3	--	2-3/16	4	6	16d	6	10d	3075	3075	3075	2350	--	3075	1275	
	HBPH71118	HB7.12/11.88	x	10	7-1/8	11-7/8	3-1/2	--	3	6	16	16d	10	16d	6185	6185	6185	4895	--	6185	2705	
	PHM35118-2	--	x	7/10	7-1/8	11-7/8	2-1/2	10	3	2	--	16d	2	10d	3390	3390	3390	2580	--	3390	--	
	PHXU71118	HWP7.12 H=11.875	x	7	7-1/8	11-7/8	3-1/4	13-1/8	2-1/2	4	4	16d	6	10d	5910	5910	5910	4525	--	5910	1120	
	HLBH71118	--	x	7	7-1/8	11-7/8	6	12	3-1/8	3	12	NA16D-RS	6	16d	10045	10045	10045	7670	--	10045	1580	
7 x 14	BPH7114	--	x	12	7-1/8	14	3	--	2-3/16	4	6	16d	6	10d	3075	3075	3075	2350	--	3075	1275	
	HBPH7114	HB7.12/14	x	10	7-1/8	14	3-1/2	--	3	6	16	16d	10	16d	6185	6185	6185	4895	--	6185	2705	
	PHM3514-2	--	x	7/10	7-1/8	14	2-1/2	10	3	2	--	16d	2	10d	3390	3390	3390	2580	--	3390	--	
	PHXU7114	HWP7.12 H=14	x	7	7-1/8	14	3-1/4	13-1/8	2-1/2	4	4	16d	6	10d	5910	5910	5910	4525	--	5910	1120	
	HLBH7114	--	x	7	7-1/8	14	6	12	3-1/8	3	12	NA16D-RS	6	16d	10045	10045	10045	7670	--	10045	1580	
7 x 16	BPH7116	--	x	12	7-1/8	16	3	--	2-3/16	4	6	16d	6	10d	3075	3075	3075	2350	--	3075	1275	
	HBPH7116	HB7.12/16	x	10	7-1/8	16	3-1/2	--	3	6	16	16d	10	16d	6185	6185	6185	4895	--	6185	2705	
	PHM3516-2	--	x	7/10	7-1/8	16	2-1/2	10	3	2	--	16d	2	10d	3390	3390	3390	2580	--	3390	--	
	PHXU7116	HWP7.12 H=16	x	7	7-1/8	16	3-1/4	13-1/8	2-1/2	4	4	16d	6	10d	5910	5910	5910	4525	--	5910	1120	
	HLBH7116	--	x	7	7-1/8	16	6	12	3-1/8	3	12	NA16D-RS	6	16d	10045	10045	10045	7670	--	10045	1580	

1) When I-joist is used as a header, all header nails must be 10d (0.148") x 1-1/2.
 2) Uplift loads have been increased 60% for wind or seismic loads; no further increase shall be permitted
 3) Some listed loads may be increased for short-term loading. Refer to MiTek code evaluation reports for details.
 4) When I-Joists with flanges less than 1-1/2" thick are used as headers, the reduction factor for 1-1/4" flange is 0.69 and 0.84 for 1-3/8" flange.
 5) **NAILS:** 10d nails are 0.148" dia. x 3" long, NA16D-RS nails are 0.148" x 3-1/2" long, 16d nails are 0.162" dia. x 3-1/2" long.
Load tables address hanger/header/fastener limitations only. Joist limitations must be determined for each installation.

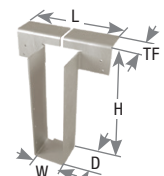

Continued on next page

Joist Size (in)	MiTek Stock No.	Ref. No.	Web Stiff Req'd	Ga	Dimensions (in)					Fastener Schedule ⁵					Allowable Loads Header Type (Lbs.) ^{1,3}							Code Ref.
					W	H	D	L	TF	Header			Joist		Download 100%					Uplift ²		
										Top Qty	Face Qty	Type	Qty	Type	LVL	PSL	LSL	SPF	I-Joist ⁴		DF/SP	
7 x 18	BPH7118	--	x	12	7-1/8	18	3	--	2-3/16	4	6	16d	6	10d	3075	3075	3075	2350	--	3075	1275	IBC, FL, LA
	HBP7118	HB7.12/18	x	10	7-1/8	18	3-1/2	--	3	6	16	16d	10	16d	6185	6185	6185	4895	--	6185	2705	
	PHM3518-2	--	x	7/10	7-1/8	18	2-1/2	10	3	2	--	16d	2	10d	3390	3390	3390	2580	--	3390	--	
	PHXU7118	HWP7.12 H=18, HWP7.12 H=18	x	7	7-1/8	18	3-1/4	13-1/8	2-1/2	4	4	16d	6	10d	5910	5910	5910	4525	--	5910	1120	
	HLBH7118	--	x	7	7-1/8	18	6	12	3-1/8	3	12	NA16D-RS	6	16d	10045	10045	10045	7670	--	10045	1580	
7 x 20	BPH7120	--	x	12	7-1/8	20	3	--	2-3/16	4	6	16d	6	10d	3075	3075	3075	2350	--	3075	1275	
	HBP7120	HB7.12/20	x	10	7-1/8	20	3-1/2	--	3	6	16	16d	10	16d	6185	6185	6185	4895	--	6185	2705	
	PHM3520-2	--	x	7/10	7-1/8	20	2-1/2	10	3	2	--	16d	2	10d	3390	3390	3390	2580	--	3390	--	
	PHXU7120	HWP7.12 H=20, HWP7.12 H=20	x	7	7-1/8	20	3-1/4	13-1/8	2-1/2	4	4	16d	6	10d	5910	5910	5910	4525	--	5910	1120	
	HLBH7120	--	x	7	7-1/8	20	6	12	3-1/8	3	12	NA16D-RS	6	16d	10045	10045	10045	7670	--	10045	1580	
7 x 22	BPH7122	--	x	12	7-1/8	22	3	--	2-3/16	4	6	16d	6	10d	3075	3075	3075	2350	--	3075	1275	
	HBP7122	HB7.12/22	x	10	7-1/8	22	3-1/2	--	3	6	16	16d	10	16d	6185	6185	6185	4895	--	6185	2705	
	PHXU7122	HWP7.12 H=22, HWP7.12 H=22	x	7	7-1/8	22	3-1/4	13-1/8	2-1/2	4	4	16d	6	10d	5910	5910	5910	4525	--	5910	1120	
	HLBH7122	HGLTV7.12/22	x	7	7-1/8	22	6	12	3-1/8	3	12	NA16D-RS	6	16d	10045	10045	10045	7670	--	10045	1580	
7 x 24	BPH7124	--	x	12	7-1/8	24	3	--	2-3/16	4	6	16d	6	10d	3075	3075	3075	2350	--	3075	1275	
	HBP7124	HB7.12/24	x	10	7-1/8	24	3-1/2	--	3	6	16	16d	10	16d	6185	6185	6185	4895	--	6185	2705	
	PHXU7124	HWP7.12 H=24, HWP7.12 H=24	x	7	7-1/8	24	3-1/4	13-1/8	2-1/2	4	4	16d	6	10d	5910	5910	5910	4525	--	5910	1120	
	HLBH7124	HGLTV7.12/24	x	7	7-1/8	24	6	12	3-1/8	3	12	NA16D-RS	6	16d	10045	10045	10045	7670	--	10045	1580	
7 x 26	HBP7126	HB7.12/26	x	10	7-1/8	26	3-1/2	--	3	6	16	16d	10	16d	6185	6185	6185	4895	--	6185	2705	
	PHXU7126	HWP7.12 H=26, HWP7.12 H=26	x	7	7-1/8	26	3-1/4	13-1/8	2-1/2	4	4	16d	6	10d	5910	5910	5910	4525	--	5910	1120	
	HLBH7126	HGLTV426-2	x	7	7-1/8	26	6	12	3-1/8	3	12	NA16D-RS	6	16d	10045	10045	10045	7670	--	10045	1580	
7 x 28	HBP7128	HB7.12/28	x	10	7-1/8	28	3-1/2	--	3	6	16	16d	10	16d	6185	6185	6185	4895	--	6185	2705	
	PHXU7128	HWP7.12 H=28, HWP7.12 H=28	x	7	7-1/8	28	3-1/4	13-1/8	2-1/2	4	4	16d	6	10d	5910	5910	5910	4525	--	5910	1120	
	HLBH7128	HGLTV428-2	x	7	7-1/8	28	6	12	3-1/8	3	12	NA16D-RS	6	16d	10045	10045	10045	7670	--	10045	1580	
7 x 30	PHXU7130	HWP7.12 H=30	x	7	7-1/8	30	3-1/4	13-1/8	2-1/2	4	4	16d	6	10d	5910	5910	5910	4525	--	5910	1120	
	HLBH7130	HGLTV430-2	x	7	7-1/8	30	6	12	3-1/8	3	12	NA16D-RS	6	16d	10045	10045	10045	7670	--	10045	1580	
7 x 32	PHXU7132	--	x	7	7-1/8	32	3-1/4	13-1/8	2-1/2	4	4	16d	6	10d	5910	5910	5910	4525	--	5910	1120	
	HLBH7132	--	x	7	7-1/8	32	6	12	3-1/8	3	12	NA16D-RS	6	16d	10045	10045	10045	7670	--	10045	1580	

- 1) When I-joist is used as a header, all header nails must be 10d (0.148") x 1-1/2.
 - 2) Uplift loads have been increased 60% for wind or seismic loads; no further increase shall be permitted
 - 3) Some listed loads may be increased for short-term loading. Refer to MiTek code evaluation reports for details.
 - 4) When I-Joists with flanges less than 1-1/2" thick are used as headers, the reduction factor for 1-1/4" flange is 0.69 and 0.84 for 1-3/8" flange.
 - 5) **NAILS:** 10d nails are 0.148" dia. x 3" long, NA16D-RS nails are 0.148" x 3-1/2" long, 16d nails are 0.162" dia. x 3-1/2" long.
- Load tables address hanger/header/fastener limitations only. Joist limitations must be determined for each installation.**

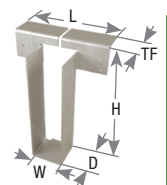

The TMP and TMPH are designed to make rafter-to-plate connections and eliminate time-consuming bird's-mouth notching or bevel plate installation. Both series are available in I-Joists sizes, as well as standard 2x sizes.

TMP – Adjusts to pitches from 1/12 to 6/12

TMPH – Adjusts to pitches from 6/12 to 14/12

Materials: TMP – 18 gauge;

TMPH – 16 gauge, Fulcrum – 12 gauge

Finish: G90 galvanizing

Codes: IBC, FL, LA

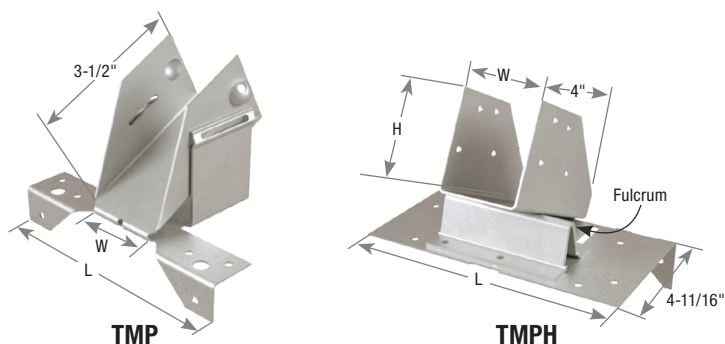

Installation:

- Use all specified fasteners. See Product Notes, page 18.
- Position connector on top plate. Fasten connector to outside of top plate with specified nails. Insert rafter into rafter pocket. Adjust rafter and pocket to correct pitch. Fasten rafter to connector with specified nails. Installing the **TMP** requires driving specified nails through the opposing slots in the pocket. **TMPH** installation involves sliding the fulcrum until it supports the pocket at the desired pitch and nailing down through the fulcrum base into the top plate to lock the fulcrum into position.

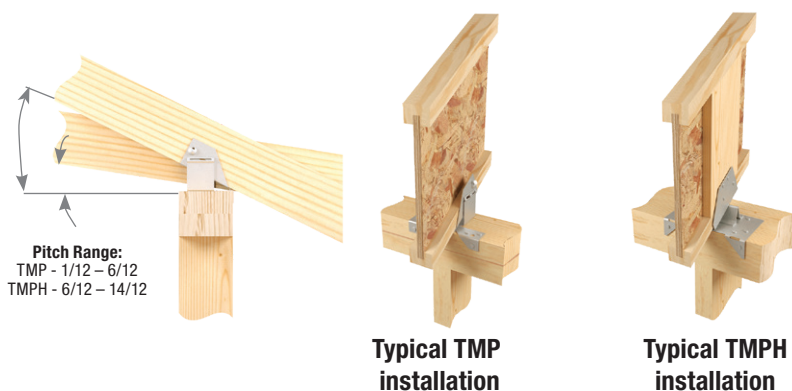

TMP Chart

Rafter Width (in)	MiTek Stock No.	Ref. No.	Steel Gauge	Dimensions (in)		Fastener Schedule ²				DF/SP		S-P-F		Code Ref.
						Plate		Rafter		Allowable Loads (Lbs.) ¹		Allowable Loads (Lbs.) ¹		
				W	L	Qty	Type	Qty	Type	Download (100/115/125)	Uplift 160%	Download (100/115/125)	Uplift 160%	
1-1/2	TMP2	VPA2	18	1-9/16	5-9/16	6	10d	4	10d x 1-1/2	1705	245	1705	190	IBC, FL, LA
1-3/4	TMP175	VPA25	18	1-13/16	5-9/16	6	10d	4	10d x 1-1/2	1705	245	1705	185	
2 or 2-1/8	TMP21	VPA2.06, VPA2.1	18	2-1/8	6-3/8	6	10d	4	10d x 1-1/2	1705	245	1705	185	
2-5/16	TMP23	VPA35	18	2-3/8	6-3/8	6	10d	4	10d x 1-1/2	1705	245	1705	185	
2-1/2 or 2-5/8	TMP25	VPA3	18	2-11/16	6-3/8	6	10d	4	10d x 1-1/2	1705	245	1705	185	
3	TMP31	--	18	3-1/8	7-5/16	6	10d	4	10d x 1-1/2	1705	245	1705	185	
3-1/2	TMP4	VPA4	18	3-9/16	7-5/16	6	10d	4	10d x 1-1/2	1705	245	1705	185	

1) Allowable loads may not be increased for duration of load adjustments.

2) **NAILS:** 10d x 1-1/2 nails are 0.148" dia. x 1-1/2" long, 10d nails are 0.148" dia. x 3" long.

TMPH Chart

Rafter Width (in)	MiTek Stock No.	Ref. No.	Dimensions (in)			Fastener Schedule ³				DF/SP										Code Ref.	
						Plate		Rafter ²		Allowable Loads (Lbs.) ¹											
			W	H	L	Top Qty	Side Qty	Type	Qty	Type	According to Pitch										Uplift 160%
6/12	7/12	8/12	9/12	10/12	11/12	12/12	13/12	14/12													
1-1/2	TMPH2	VPA2	1-9/16	2-1/2	6-9/16	8	2	10d	8	10d x 1-1/2	3190	3290	3390	3140	2900	2710	2520	2230	1950	330	IBC, FL, LA
1-3/4	TMPH175	VPA25	1-13/16	2-3/8	6-9/16	8	2	10d	8	10d x 1-1/2	3190	3290	3390	3140	2900	2710	2520	2230	1950	330	
2 or 2-1/8	TMPH21	VPA2.06, VPA2.1	2-1/8	2-5/8	7-3/8	8	2	10d	8	10d x 1-1/2	3190	3290	3390	3140	2900	2710	2520	2230	1950	330	
2-5/16	TMPH23	VPA35	2-3/8	2-1/2	7-3/8	8	2	10d	8	10d x 1-1/2	3190	3290	3390	3140	2900	2710	2520	2230	1950	330	
2-1/2 or 2-5/8	TMPH25	VPA3	2-11/16	2-5/16	7-3/8	8	2	10d	8	10d x 1-1/2	3190	3290	3390	3140	2900	2710	2520	2230	1950	330	
3	TMPH31	--	3-1/8	2-11/16	8-9/16	8	2	10d	8	10d x 1-1/2	3190	3290	3390	3140	2900	2710	2520	2230	1950	330	
3-1/2	TMPH4	VPA4	3-9/16	2-1/2	8-9/16	8	2	10d	8	10d x 1-1/2	3190	3290	3390	3140	2900	2710	2520	2230	1950	330	

1) Allowable loads may not be increased for duration of load adjustments.

2) Web stiffeners are required for all Wood I-Joist installations.

3) **NAILS:** 10d x 1-1/2 nails are 0.148" dia. x 1-1/2" long, 10d nails are 0.148" dia. x 3" long.

The LSSH series connects rafters to ridge beams in vaulted roof structures. This series is field adjustable to meet a variety of skew and/or slope applications. Slopes and skews 0° to 45°.

Materials: See chart

Finish: G-185 galvanizing

Options: See chart for Corrosion Finish Options

Codes: IBC, FL, LA

Installation:

- Use all specified fasteners. See Product Notes, page 18.

Steps:

1. Position LSSH connector against plumb-cut end of joist. Fasten joist side flanges on both sides with 10d (0.148") x 1-1/2" nails. Bend seat up to fit against joist bottom and drive (1) 10d (0.148") x 1-1/2" nail through bottom seat into rafter bottom. Drive (2) 10d (0.148") x 1-1/2" nails at downward angle through dimpled nailing guides.
 2. Lean connector and rafter end against ridge beam at desired position. Install specified 10d (0.148" x 3") or 16d (0.162" x 3-1/2") nails through nail holes into ridge beam at right 90° angle. If skewing the rafter, only drive nails into ridge beam on inside flange.
 3. Bend flange to desired angle.
 4. Hammer outside flange until edge touches header. Fasten outside flange to ridge by driving specified 10d (0.148" x 3) or 16d (0.162" x 3-1/2") nails through nail holes.
- Web stiffeners are required for all wood I-Joist installations.
 - Designer may consider adding a tension restraint for the supported member for roof slopes exceeding 6/12. Refer to page 122.



Typical LSSH179-TZ installation

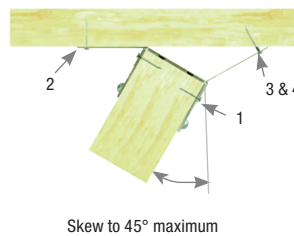

Skew to 45° maximum

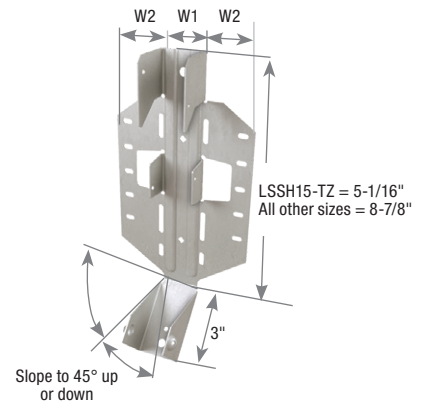

LSSH210-TZ

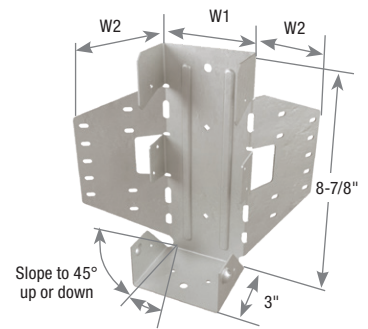

LSSH35-TZ

Rafter Width (in)	MiTek Stock No.	Ref. No.	Steel Gauge	Dimensions (in)		Fastener Schedule ^{2,3,4}				DF/SP Allowable Loads (Lbs.)				S-P-F Allowable Loads (Lbs.)				Corrosion Finish	Code Ref.
				W1	W2	Header		Rafter		Floor	Roof	Uplift ¹	160%	Floor	Roof	Uplift ¹	160%		
						Qty	Type	Qty	Type										
SLOPED ONLY HANGERS																			
1-1/2	LSSH15-TZ	--	18	1-9/16	1-3/4	6	10d	7	10d x 1-1/2	720	820	885	565	640	730	785	440		IBC, FL, LA
1-1/2	LSSH210-TZ	--	18	1-9/16	1-3/4	10	10d	7	10d x 1-1/2	1200	1370	1395	410	1065	1090	1090	320		
1-3/4	LSSH179-TZ	--	18	1-13/16	1-5/8	10	10d	7	10d x 1-1/2	1200	1370	1395	880	1065	1090	1090	690		
2 - 2-1/8	LSSH20-TZ	--	18	2-1/8	2-1/2	10	10d	7	10d x 1-1/2	1200	1370	1395	795	1065	1085	1085	620		
2-1/4 - 2-5/16	LSSH23-TZ	--	18	2-5/16	2-3/8	10	10d	7	10d x 1-1/2	1200	1370	1395	795	1065	1085	1085	620		
2-1/2	LSSH25-TZ	--	16	2-9/16	2-3/4	18	16d	12	10d x 1-1/2	2095	2095	2095	945	1640	1640	1640	740		
2-5/8	LSSH26-TZ	--	16	2-11/16	2-5/8	18	16d	12	10d x 1-1/2	2095	2095	2095	945	1640	1640	1640	740		
3	LSSH31-TZ	--	16	3-1/8	3-3/4	18	16d	12	10d x 1-1/2	2645	3000	3090	1310	2345	2415	2415	1025		
3-1/2	LSSH35-TZ	--	16	3-9/16	3-1/2	18	16d	12	10d x 1-1/2	2645	3000	3090	1310	2345	2405	2405	1020		
SKEWED HANGERS or SLOPED & SKEWED HANGERS																			
1-1/2	LSSH15-TZ	--	18	1-9/16	1-3/4	6	10d	7	10d x 1-1/2	620	620	620	510	485	485	485	400		IBC, FL, LA
1-1/2	LSSH210-TZ	--	18	1-9/16	1-3/4	10	10d	7	10d x 1-1/2	1200	1370	1395	880	1065	1090	1090	690		
1-3/4	LSSH179-TZ	--	18	1-13/16	1-5/8	10	10d	7	10d x 1-1/2	1200	1370	1395	880	1065	1090	1090	690		
2 - 2-1/8	LSSH20-TZ	--	18	2-1/8	2-1/2	10	10d	7	10d x 1-1/2	1200	1230	1230	795	960	960	960	620		
2-1/4 - 2-5/16	LSSH23-TZ	--	18	2-5/16	2-3/8	10	10d	7	10d x 1-1/2	1200	1230	1230	795	955	955	955	620		
2-1/2	LSSH25-TZ	--	16	2-9/16	2-3/4	14	16d	12	10d x 1-1/2	1610	1610	1610	945	1260	1260	1260	740		
2-5/8	LSSH26-TZ	--	16	2-11/16	2-5/8	14	16d	12	10d x 1-1/2	1610	1610	1610	945	1260	1260	1260	740		
3	LSSH31-TZ	--	16	3-1/8	3-3/4	14	16d	12	10d x 1-1/2	1610	1610	1610	1310	1260	1260	1260	1025		
3-1/2	LSSH35-TZ	--	16	3-9/16	3-1/2	14	16d	12	10d x 1-1/2	1610	1610	1610	1310	1255	1255	1255	1020		

- 1) Uplift loads have been increased 60% for wind or seismic loads; no further increase shall be permitted.
- 2) Stainless steel ring shank nails must be used with stainless steel connectors to achieve tabulated allowable loads.
- 3) For exterior applications, hot-dip galvanized (HDG) fasteners must be used.
- 4) **NAILS:** 10d x 1-1/2 nails are 0.148" dia. x 1-1/2" long, 10d nails are 0.148" dia. x 3" long, 16d nails are 0.162" dia. x 3-1/2" long. New products or updated product information are designated in **blue font**.

Corrosion Finish Key

- Stainless Steel ■ Gold Coat
- HDG ■ Triple Zinc

LGU, MGU, and HGU's are high capacity girder to girder face mount connectors. Fastens with MiTek's WS structural wood screws for ease of installation. Fasteners are placed high on connector to permit the connection of a deep carried member to a shallower carrying member. Very useful where tops of beams must be flush.

Materials: LGU/MGU – 10 gauge; HGU – 7 gauge

Finish: G90 galvanizing

Options: See Specialty Options Chart

Codes: IBC, FL, LA

Installation:

- Use all specified fasteners. See Product Notes, page 18.
- Install with MiTek's WS structural wood screws supplied with connector.
- Beams comprised of multiple plies must be laminated to act as a single member.
- Multi-ply carrying beams may require additional connection of laminations at connector.
- Beam height dimension (H) must be specified when ordering.



Typical LGU, MGU, HGU installation

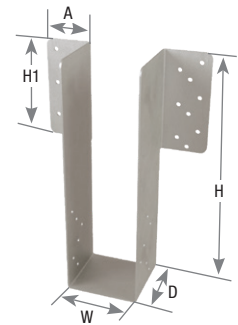

LGU, MGU, HGU

Beam Width (in)	MiTek Stock No.	Ref. No.	Steel Gauge	Dimensions (in)					Fastener Schedule ³				DF/SP Allowable Loads (Lbs.)				S-P-F Allowable Loads (Lbs.)				Code Ref.
				W	H ² (min)	H1	D	A	Header		Truss		Allowable Loads (Lbs.)				Allowable Loads (Lbs.)				
									Qty	Type	Qty	Type	100%	115%	125%	160%	100%	115%	125%	160%	
3-1/8	LGU325	LGU3.25-SDS	10	3-1/4	8	7-3/8	4-1/2	3-1/4	18	WS3	12	WS3	7135	7410	7410	3975	5960	5960	5960	3195	IBC, FL, LA
	LGU363	LGU3.63-SDS	10	3-5/8	8	7-3/8	4-1/2	3-1/4	18	WS3	12	WS3	7135	7410	7410	3975	5945	5945	5945	3190	
3-1/2	MGU363	MGU3.63-SDS	10	3-5/8	9-1/4	8-5/8	4-1/2	4	24	WS3	16	WS3	9515	10940	11890	5060	8355	9610	9705	4085	
	HGU363	HGU3.63-SDS	7	3-5/8	11	10-3/8	5-1/4	4-3/4	38	WS3	24	WS3	14705	14990	14990	7375	12175	12175	12175	5990	
5-1/8	LGU525	LGU5.25-SDS	10	5-1/4	8	7-3/8	4-1/2	3-1/4	18	WS3	12	WS3	7135	7410	7410	3975	5910	5910	5910	3170	
	MGU525	MGU5.25-SDS	10	5-1/4	9-1/4	8-5/8	4-1/2	4	24	WS3	16	WS3	9515	10940	11890	5060	8355	9610	9640	4055	
	HGU525	HGU5.25-SDS	7	5-1/4	11	10-3/8	5-1/4	4-3/4	38	WS3	24	WS3	14705	14990	14990	7375	12070	12070	12070	5935	
5-1/4	MGU550	MGU5.50-SDS	10	5-1/2	9-1/4	8-5/8	4-1/2	4	24	WS3	16	WS3	9515	10940	11890	5060	8355	9610	9635	4055	
	HGU550	HGU5.50-SDS	7	5-1/2	11	10-3/8	5-1/4	4-3/4	38	WS3	24	WS3	14705	14990	14990	7375	12060	12060	12060	5930	
5-1/2	MGU562	MGU5.62-SDS	10	5-5/8	9-1/4	8-5/8	4-1/2	4	24	WS3	16	WS3	9515	10940	11890	5060	8355	9610	9625	4050	
	HGU562	HGU5.62-SDS	7	5-5/8	11	10-3/8	5-1/4	4-3/4	38	WS3	24	WS3	14705	14990	14990	7375	12050	12050	12050	5930	
6-3/4	MGU700	MGU7.00-SDS	10	7	9-1/4	8-5/8	4-1/2	4	24	WS3	16	WS3	9515	10940	11890	5060	8355	9590	9590	4035	
	HGU700	HGU7.00-SDS	7	7	11	10-3/8	5-1/4	4-3/4	38	WS3	24	WS3	14705	14990	14990	7375	12010	12010	12010	5910	
7	HGU725	HGU7.25-SDS	7	7-1/4	11	10-3/8	5-1/4	4-3/4	38	WS3	24	WS3	14705	14990	14990	7375	12000	12000	12000	5905	
8-3/4	HGU900	HGU9.00-SDS	7	9	11	10-3/8	5-1/4	4-3/4	38	WS3	24	WS3	14705	14990	14990	7375	11960	11960	11960	5885	

1) Uplift loads have been increased 60% for wind or seismic loads; no further increase shall be permitted.
 2) H denotes minimum hanger height. Specify height when ordering.
 3) MiTek's WS3 structural wood screws are 1/4" dia. x 3" long and are included with hangers.

Specialty Options Chart

– refer to Specialty Options pages 320-321 for additional details

Option	MiTek Series	Skewed ^{1,4,5}	Inverted Flange ^{2,3}
Range	LGU MGU HGU	1° to 45°	One Inverted Flange option available on some sizes. See footnotes 2 and 3.
Allowable Loads	LGU	55% of table value. 30% of uplift.	100% of table value
	MGU	65% of table value. 30% of uplift.	
	HGU	70% of table value. 30% of uplift.	
Ordering	LGU MGU HGU	Add <i>SK</i> , angle required, right (<i>R</i>) or left (<i>L</i>), and bevel cut (<i>BV</i>) to product number. Ex. LGU525_H=18_SK45R_BV	Add <i>IF</i> and right (<i>R</i>) or left (<i>L</i>) to product number. Ex. LGU525_H=18_IFR

- 1) Skewed hangers with skews greater than 15° may have all joist fasteners on outside flange.
- 2) One inverted-flange (IF) is available on the following sizes: LGU363, LGU525, MGU525, MGU550, MGU563, MGU700, HGU525, HGU550, HGU562, HGU700, HGU725, HGU900
- 3) The inverted flange option is not available on skewed LGU, MGU or HGU hangers.
- 4) Bevel cut required on skewed parts to meet table loads.
- 5) Square cut option may be available as a custom, contact MiTek.

GHF Glulam Face Mount Hangers

Glulam Beam Connectors

An architectural choice for exposed glulam purlin applications. The GHF features heavy load capacity and a multitude of optional designs for unusual applications. Header fasteners are positioned high and joist flange fasteners low for best design with glulam members.

Materials: See chart

Finish: Primer

Options: See Specialty Options Chart on page 234

Installation:

- Use all specified fasteners. See Product Notes, page 18.
- MiTek's WS structural wood screws are supplied with GHF hangers.



Typical GHF51135 installation

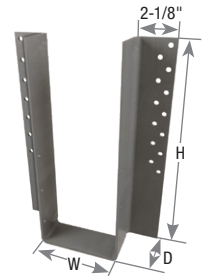

GHF

Glulam Beam Connectors

Glulam Size (in)	MiTek Stock No.	Ref. No.	Steel Gauge	Dimensions (in)			Fastener Schedule ²				DF/SP Allowable Loads (Lbs.) ¹				Code Ref.
				W	H	D	Header		Joist		Allowable Loads (Lbs.) ¹				
							Qty	Type	Qty	Type	Floor	Roof		Uplift ³	
3-1/8 x 6	GHF31600	--	12	3-3/16	5-7/8	2-3/8	10	WS25	4	WS25	2740	2740	2740	1400	
3-1/8 x 7-1/2	GHF31750	--	12	3-3/16	7-3/8	2-3/8	12	WS25	4	WS25	3285	3285	3285	1400	
3-1/8 x 9	GHF31900	--	12	3-3/16	8-7/8	2-3/8	16	WS25	5	WS25	4380	4380	4380	1750	
3-1/8 x 10-1/2	GHF31105	--	12	3-3/16	10-3/8	2-3/8	20	WS25	6	WS25	5475	5475	5475	2100	
3-1/8 x 12	GHF31120	--	12	3-3/16	11-7/8	2-3/8	22	WS25	6	WS25	5800	5800	5800	2100	
3-1/8 x 13-1/2	GHF31135	--	12	3-3/16	13-3/8	2-3/4	24	WS25	6	WS25	5800	5800	5800	2100	
3-1/8 x 15	GHF31150	--	12	3-3/16	14-7/8	2-3/4	26	WS25	7	WS25	6730	6730	6730	2455	
3-1/8 x 16-1/2	GHF31165	--	12	3-3/16	16-3/8	2-3/4	28	WS25	9	WS25	7275	7275	7275	3155	
3-1/8 x 18	GHF31178	--	12	3-3/16	17-3/4	2-3/4	30	WS25	11	WS25	7825	7825	7825	3855	
3-1/4 x 9	GHF32900	--	12	3-5/16	8-7/8	2-3/8	16	WS25	5	WS25	4380	4380	4380	1750	
3-1/4 x 12	GHF32120	--	12	3-5/16	11-7/8	2-3/8	22	WS25	6	WS25	5800	5800	5800	2100	
5-1/8 x 6	GHF51600	--	12	5-3/16	5-7/8	2-3/8	10	WS3	4	WS3	2740	2740	2740	1400	
5-1/8 x 7-1/2	GHF51750	--	12	5-3/16	7-3/8	2-3/8	14	WS3	4	WS3	3835	3835	3835	1400	
5-1/8 x 9	GHF51900	--	12	5-3/16	8-7/8	2-3/8	18	WS3	5	WS3	4930	4930	4930	1750	
5-1/8 x 10-1/2	GHF51105	--	12	5-3/16	10-3/8	2-3/8	22	WS3	6	WS3	6025	6025	6025	2100	
5-1/8 x 12	GHF51120	--	12	5-3/16	11-7/8	2-3/8	24	WS3	6	WS3	6570	6570	6570	2100	
5-1/8 x 13-1/2	GHF51135	--	7	5-3/16	13-3/8	2-3/8	26	WS3	6	WS3	8125	8125	8125	2400	
5-1/8 x 15	GHF51150	--	7	5-3/16	14-7/8	2-3/4	28	WS3	7	WS3	8750	8750	8750	2800	
5-1/8 x 16-1/2	GHF51165	--	7	5-3/16	16-3/8	2-3/4	30	WS3	7	WS3	9375	9375	9375	2800	
5-1/8 x 18	GHF51178	--	7	5-3/16	17-3/4	2-3/4	32	WS3	8	WS3	10000	10000	10000	3200	--
5-1/8 x 19-1/2	GHF51192	--	7	5-3/16	19-1/8	2-3/4	34	WS3	8	WS3	10395	10395	10395	3200	
5-1/8 x 21	GHF51205	--	7	5-3/16	20-3/8	2-3/4	36	WS3	9	WS3	10705	10705	10705	3600	
5-1/8 x 24	GHF51233	--	7	5-3/16	23-1/4	2-3/4	40	WS3	11	WS3	11330	11330	11330	4400	
5-1/4 x 9	GHF52900	--	12	5-5/16	8-7/8	2-3/8	18	WS3	5	WS3	4930	4930	4930	1750	
5-1/4 x 12	GHF52120	--	12	5-5/16	11-7/8	2-3/8	24	WS3	6	WS3	6570	6570	6570	2100	
6-3/4 x 6	GHF67600	--	12	6-7/8	5-7/8	2-3/8	12	WS3	4	WS3	3285	3285	3285	1400	
6-3/4 x 7-1/2	GHF67750	--	12	6-7/8	7-3/8	2-3/8	16	WS3	5	WS3	4380	4380	4380	1750	
6-3/4 x 9	GHF67900	--	12	6-7/8	8-7/8	2-3/8	20	WS3	6	WS3	5475	5475	5475	2100	
6-3/4 x 10-1/2	GHF67105	--	12	6-7/8	10-3/8	2-3/8	24	WS3	8	WS3	6570	6570	6570	2805	
6-3/4 x 12	GHF67120	--	7	6-7/8	11-7/8	2-3/4	28	WS3	8	WS3	8750	8750	8750	3200	
6-3/4 x 13-1/2	GHF67135	--	7	6-7/8	13-3/8	2-3/4	30	WS3	8	WS3	9375	9375	9375	3200	
6-3/4 x 15	GHF67150	--	7	6-7/8	14-7/8	2-3/4	32	WS3	10	WS3	10000	10000	10000	4000	
6-3/4 x 16-1/2	GHF67165	--	7	6-7/8	16-3/8	2-3/4	34	WS3	10	WS3	10625	10625	10625	4000	
6-3/4 x 18	GHF67180	--	7	6-7/8	17-3/4	2-3/4	36	WS3	12	WS3	11250	11250	11250	4800	
6-3/4 x 19-1/2	GHF67195	--	7	6-7/8	19-1/8	3	40	WS3	14	WS3	12500	12500	12500	5600	
6-3/4 x 21	GHF67210	--	7	6-7/8	20-3/8	3	44	WS3	18	WS3	13000	13000	13000	7200	
6-3/4 x 22-1/2	GHF67225	--	7	6-7/8	21-7/8	3	46	WS3	20	WS3	13000	13000	13000	8000	
6-3/4 x 24	GHF67240	--	7	6-7/8	23-1/4	3	48	WS3	22	WS3	13000	13000	13000	8800	

1) Allowable loads based on seat bearing calculated at 560 psi perpendicular to grain.

2) MiTek's WS25 (1/4" dia. x 2-1/2" long) and WS3 (1/4" dia. x 3" long) structural wood screws are included with GHF hangers.

3) Uplift loads have been increased 60% for wind or seismic loads; no further increase shall be permitted.

Continued on next page

Specialty Options Chart

– refer to Specialty Options pages 320-321 for additional details

Option	Skewed ^{1,3}	Sloped Seat ²	Sloped / Skewed ^{1,2}	Inverted Flange
Range	1° to 50°	1° to 45°	See Sloped Seat and Skewed	Not available in widths less than 4-1/2"
Allowable Loads	100% of table load. 75% of uplift load on skewes greater than 15°.	100% of table load	80% of table load 75% of uplift load on skewes greater than 15°.	100% of table load. 65% of table load when fastening into the support members end grain.
Ordering	Add <i>SK</i> , angle required, right (<i>R</i>) or left (<i>L</i>), and square cut (<i>SQ</i>) or bevel cut (<i>BV</i>) to product number. Ex. GHF31900_SK45R_BV	Add <i>SL</i> , slope required, and up (<i>U</i>) or down (<i>D</i>), to product number. Ex. GHF31900_SL30D	See Sloped Seat and Skewed. Ex. GHF31900_SK45R_BV_SL30D	Add <i>IF</i> to product number. Ex. GHF51135_IF

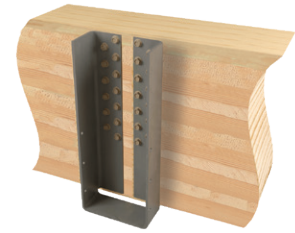

Typical GHF51135IF inverted flange installation

- 1) Skewed hangers with skewes greater than 15° may have all joist nailing on outside flange.
- 2) Sloped or sloped / skewed hangers with slopes greater than 15° may have additional joist nails.
- 3) Skewed hangers typically require a bevel cut however, a square cut option may be available as a custom when requested.

KEGQ Glulam Beam Hangers

MiTék's WS structural wood screw fastening, heavy steel construction, and a continuous top flange allow the KEGQ products to have high load capacities.

Materials: See chart

Finish: Primer

Codes: IBC, FL, LA

Installation:

- Install with MiTék's WS structural wood screws.
- MiTék's WS3 structural wood screws, 1/4" dia. x 3" long, are supplied with KEGQ hangers.
- **Minimum header height (H) is 11-7/8".**
- Beam height dimension (H) must be specified when ordering.



Typical KEGQ550 installation

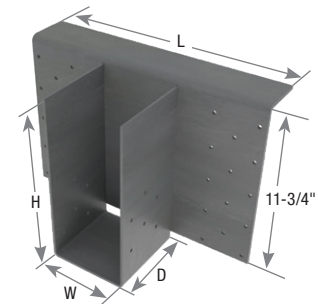

KEGQ

Joist / Purlin Size	MiTék Stock No.	Ref. No.	Steel Ga.		Dimensions (in)				Fastener Schedule ³				DF/SP Allowable Loads (Lbs.)				S-P-F Allowable Loads (Lbs.)				Code Ref.
			Top Flange	U-Strap	W	H ²	D	L	Header		Joist		Download		Uplift ¹	Download			Uplift ¹		
									Qty	Type	Qty	Type	100%	115%	125%	160%	100%	115%	125%	160%	
3-1/2	KEGQ362	EGQ3.62-SDS3	3	7	3-5/8	specify	6	18	28	WS3	12	WS3	17265	17265	17265	4695	13005	13615	13795	3750	IBC, FL, LA
5-1/4	KEGQ550	EGQ5.25-SDS3	3	7	5-1/2	specify	6	18	28	WS3	12	WS3	17265	17265	17265	7430	13720	13720	13720	6525	
7	KEGQ725	EGQ7.25-SDS3	3	7	7-1/4	specify	6	18	28	WS3	12	WS3	17265	17265	17265	7430	13680	13680	13680	6525	

- 1) Uplift loads have been increased 60% for wind and seismic loads; no further increase shall be permitted.
- 2) "Specify" denotes the required supported beam height that must be specified at the time of ordering, with 11" being the minimum.
- 3) MiTék's WS3 structural wood screws are 1/4" dia. x 3" long and are included with KEGQ hangers.

Bolt-only fastening, heavy steel construction, and a continuous top flange allow the KLEG, KMEG, and KEG products to have high load capacities.

KLEG – (4) bolt light-duty hanger.

KMEG – (6) bolt medium-duty hanger.

KEG – (8) bolt heavy-duty hanger.

Materials: See chart

Finish: Primer

Options: See Specialty Options Chart

Codes: IBC, FL, LA

Installation:

- Use all specified fasteners. See Product Notes, page 18.
- **Minimum header height is 10" for the KLEG; 13" for the KMEG; 20" for the KEG.**
- Supported beam height dimension (H) must be specified when ordering.

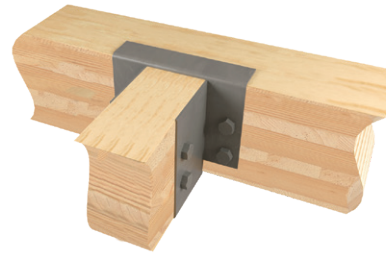

Typical KLEG5 installation

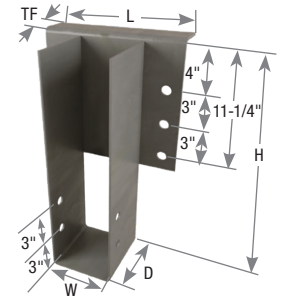

KMEG5

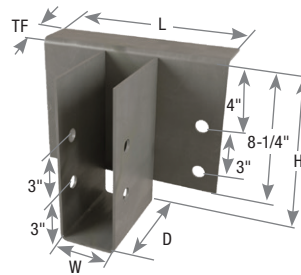

KLEG3



KLEG without top flange

Beam Width (in)	MiTek Stock No.	Ref. No.	Steel Ga.		Dimensions (in)					Bolt Schedule				Allowable Loads (Lbs.)					Code Ref.
			Top Flange	U-Strap	W	H ³	D	TF	L	Header		Joist		With Top Flange ¹		Without Top Flange ¹		Uplift 160%	
										Qty	Dia (in)	Qty	Dia (in)	100%	125%	100%	125%		
3-1/8	KLEG3	LEG3	7	7	3-1/4	specify	6	2-1/2	12	4	3/4	2	3/4	11980	12165	3580	4470	3845	IBC, FL, LA
5-1/8	KLEG5	LEG5	7	7	5-1/4	specify	6	2-1/2	12	4	3/4	2	3/4	11980	12165	3580	4470	4690	
	KMEG5	MEG5	7	7	5-1/4	specify	6	2-1/2	12	6	3/4	2	3/4	12635	12635	5345	6685	4690	
6-3/4	KEG5	EG5	3	7	5-1/4	specify	6	2-1/2	12	8	1	2	1	17615	19920	9215	11520	7305	
	KLEG7	LEG7	7	7	6-7/8	specify	6	2-1/2	12	4	3/4	2	3/4	11980	12165	3580	4470	4690	
	KMEG7	MEG7	7	7	6-7/8	specify	6	2-1/2	12	6	3/4	2	3/4	12635	12635	5345	6685	4690	
8-3/4	KEG7	EG7	3	7	6-7/8	specify	6	2-1/2	13-1/2	8	1	2	1	18695	21005	9245	11555	9275	
	KEG9	EG9	3	7	8-7/8	specify	6	2-1/2	15-1/2	8	1	2	1	20125	21145	9275	11595	9305	
10-3/4	KEG11	--	3	7	10-7/8	specify	6	2-1/2	17-1/2	8	1	2	1	21145	21145	9295	11620	9325	

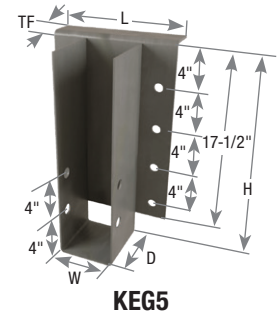

KEG5

1) Allowable loads are for a supporting member with a width of 5-1/2", and 560 psi perpendicular to grain loading in single shear.
 2) Uplift loads have been increased 60% for wind and seismic loads; no further increase shall be permitted.
 3) "Specify" denotes the required supported beam height that must be specified at the time of ordering, with 12" being the minimum.

Specialty Options Chart

– refer to Specialty Options pages 320 and 322-323 for additional details

Option	Skewed ³	Sloped Seat	Top Flange Offset ^{1,2}
Range	1° to 45°	1° to 45°	--
Allowable Loads	KLEG – 10,000-lb Max KMEG – 10,000-lb Max KEG – 14,250-lb Max	KLEG – 9,665 lbs. Max KMEG – 9,665 lbs. Max KEG – 9,665 lbs. Max	KLEG – 5,665-lb Max KLEG – 9" Min Height KMEG – 5665 lbs. Max KMEG – 11" Min Height
Ordering	Add <i>SK</i> , angle required, right (<i>R</i>) or left (<i>L</i>), and square cut (<i>SQ</i>) to product number. Ex. KLEG3_H=11_SK45R_SQ	Add <i>SL</i> , slope required, and up (<i>U</i>) or down (<i>D</i>), to product number. Ex. KLEG3_H=11_SL30D	Add <i>OS</i> , and right (<i>R</i>) or left (<i>L</i>), to product number. Ex. KLEG3_H=11_OSL

1) Top flange offset hangers may not be skewed.
 2) Top flange offset option is not available for KEG models.
 3) Carried member must have square cut end on skewed option.
 Refer to Typical HLBH hanger, skewed, left shown, square cut illustration on page 322.

These hangers cover medium-to-heavy glulam beam and purlin applications.

KHHB – Medium capacity hanger

KGB – Medium-to-heavy capacity hanger

KHGB – Heavy capacity hanger

Materials: 7 gauge

Finish: Primer

Codes: IBC, FL, LA



Typical KHHB installation

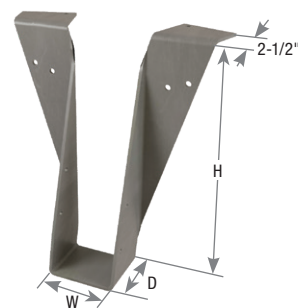

KHHB

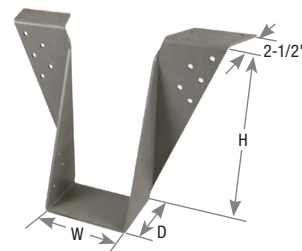

KGB

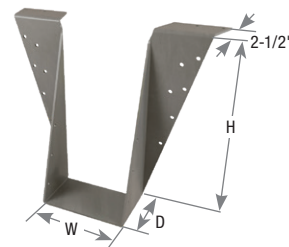

KHGB

- Installation:**
- Use all specified fasteners. See Product Notes, page 18.
 - MiTek's WS3 structural wood screws are supplied with hangers.
 - Beam height dimension (H) must be specified when ordering.
 - **Minimum height (H) is 7-1/2".**
 - See welded installation chart on page 325.

Beam Width (in)	MiTek Stock No.	Ref. No.	Dimensions (in) ²			Fastener Schedule ⁴					Allowable Loads (Lbs.)				Code Ref.
			W	H	D	Header ³		Joist			F _C ^A = 625 psi			Uplift ¹ 160%	
						Top Qty	Face Qty	Type	Qty	Type	Floor	Roof			
												100%	115%		
3-1/8	KHHB3	--	3-1/4	specify	3	4	6	WS3	6	WS3	6480	6480	6480	2215	IBC, FL, LA
	KGB3	--			3-1/2	4	10	WS3	6	WS3	6480	6480	6480	2215	
5-1/8	KHHB5	--	5-1/4	specify	3	4	6	WS3	6	WS3	6480	6480	6480	2215	
	KGB5	--			3-1/2	4	10	WS3	6	WS3	6480	6480	6480	2215	
	KHGB5	--			4	4	12	WS3	6	WS3	6480	6480	6480	2215	
6-3/4	KHHB7	--	6-7/8	specify	3	4	6	WS3	6	WS3	6480	6480	6480	2215	
	KGB7	--			3-1/2	4	10	WS3	6	WS3	6480	6480	6480	2215	
	KHGB7	--			4	4	12	WS3	6	WS3	6480	6480	6480	2215	

1) Uplift loads have been increased 60% for wind or seismic loads; no further increase shall be permitted.
 2) "Specify" denotes the required supported beam height must be specified at the time of ordering.
 3) Supporting header shall be no less than 3" thick.
 4) MiTek's WS3 structural wood screws are 1/4" dia. x 3" long and are included with hangers.

These heavy beam hangers are designed for use with glulam and timber beams. The continuous top mount flange offers high load capacity with minimal fastening.

KGLT – Medium capacity hanger

KHGLT – Heavy capacity hanger

Materials: See chart

Finish: Primer

Options: See Nailer Options chart below and Specialty Options Chart on page 238

Codes: IBC, FL, LA

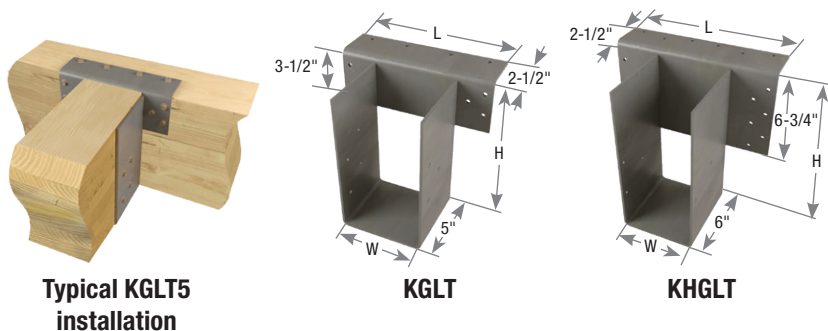

Installation:

- Use all specified fasteners. See Product Notes, page 18.
- Beam height dimension (H) must be specified when ordering.
- See welded installation chart on page 325.

Beam Width (in)	MiTek Stock No.	Ref. No.	Steel Gauge		Dimensions (in)			Fastener Schedule ⁴					Allowable Loads (Lbs.) ²				Code Ref.
			Top Flange	U-Strap	W	H ³	L	Header			Joist		Floor			Uplift ¹ 160%	
								Top Qty	Face Qty	Type	Qty	Type	100% ³	115%	125%		
3-1/8	KGLT3	--	3	7	3-1/4	specify	10	4	6	WS3	8	WS3	10555	10965	11055	1935	IBC, FL, LA
	KHGLT3	HGLT3					12	6	12	WS3	6	WS3	12495	12495	12495	1935	
3-1/2	KGLT4	--	3	7	3-5/8	specify	10	4	6	WS3	8	WS3	10555	10965	11055	1935	
	KHGLT4	HGLT4, HGLTV4					12	6	12	WS3	6	WS3	12495	12495	12495	1935	
5-1/8	KGLT5	--	3	7	5-1/4	specify	10	4	6	WS3	8	WS3	10555	10965	11055	1935	
	KHGLT5	HGLT5, HGLTV5					12	6	12	WS3	6	WS3	12495	12495	12495	1935	
5-5/16	KHGLT537	HGLTV5.37	3	7	5-3/8	specify	12	6	12	WS3	6	WS3	12495	12495	12495	1935	
5-1/2	KGLT6	--	3	7	5-5/8	specify	12	4	6	WS3	8	WS3	10555	10965	11055	1935	
	KHGLT6	HGLT6, HGLTV6					12	6	12	WS3	6	WS3	12495	12495	12495	1935	
6-3/4	KGLT7	--	3	7	6-7/8	specify	12	4	6	WS3	8	WS3	10555	10965	11055	1935	
	KHGLT7	HGLT7, HGLTV7					12	6	12	WS3	6	WS3	12495	12495	12495	1935	
8-3/4	KGLT9	--	3	7	8-7/8	specify	14	4	6	WS3	8	WS3	10555	10965	11055	1935	
	KHGLT9	HGLT9					14	6	12	WS3	6	WS3	12495	12495	12495	1935	
10-3/4	KHGLT11	--	3	7	10-7/8	specify	16	6	12	WS3	6	WS3	12495	12495	12495	1935	

- 1) Uplift loads have been increased 60% for wind or seismic loads; no further increase shall be permitted.
- 2) Allowable Loads are based on 625 psi perpendicular to grain loading.
- 3) "Specify" denotes the required supported beam height that must be specified at time of ordering, with 7-1/2" being the minimum.
- 4) MiTek's WS3 structural wood screws are 1/4" dia. x 3" long and are included with the hangers.

KGLT Nailer Options

– chart represents maximum allowable loads for hangers used on wood nailers. Reference page 203.

MiTek Series	Nailer Size	Fastener Schedule ^{2,3}					DF/SP		SPF	
		Nailer			Joist		Allowable Loads (Lbs.) ^{1,4}		Allowable Loads (Lbs.) ^{1,4}	
		Top Qty	Face Qty	Type	Qty	Type	Download 100%	Uplift 160%	Download 100%	Uplift 160%
KGLT	2x	4	--	WS15	8	WS15	5210	--	4375	--
	3x	4	2	WS15	8	WS15	6655	--	5590	--
	(2) 2x	4	4	WS3	8	WS3	6430	--	5400	--
	4X	4	6	WS3	8	WS3	6040	1925	5075	1615

- 1) Listed loads shall not be increased.
 - 2) MiTek's WS15 structural wood screws are 1/4" dia. x 1-1/2" long and are not included with hangers.
 - 3) MiTek's WS3 structural wood screws are 1/4" dia. x 3" long and are included with hangers.
 - 4) **Values in the table apply to standard top mount hangers without slope, skew or any other specialty options.**
- New products or updated product information are designated in **blue font**.

Continued on next page

Specialty Options Chart

– refer to Specialty Options pages 320 and 322-323 for additional details

Option	Skewed ^{1,3}	Sloped Seat ^{2,3}	Sloped / Skewed ^{1,2,3}	Sloped Top Flange ⁴	Top Flange Offset	Saddle
Range	1° to 50°	1° to 45°	See Sloped Seat and Skewed	0° to 45°	--	--
Allowable Loads	50% of uplift load on skew greater than 15°	KGLT – 4,110-lb Max KHGLT – 7,000-lb Max	50% of uplift load on skew greater than 15°	100% of table load	60% of table load for KGLT. 45% of table load for KHGLT.	100% of table load per side
Ordering	Add <i>SK</i> , angle required, right (<i>R</i>) or left (<i>L</i>), and square cut (<i>SQ</i>) or bevel cut (<i>BV</i>) to product number. Ex. KGLT3_H=16_SK45R_BV	Add <i>SL</i> , slope required, and up (<i>U</i>) or down (<i>D</i>), to product number. Ex. KGLT3_H=16_SL30D	See Sloped Seat and Skewed. Ex. KGLT3_H=16_SK45R_BV_SL30D	Add <i>SLTF</i> , angle required and right (<i>R</i>) or left (<i>L</i>), to product number. Ex. KGLT3_H=16_SLTF30L	Add <i>OS</i> , and right (<i>R</i>) or left (<i>L</i>), to product number. Ex. KGLT3_H=16_0SL	Add <i>SA</i> , and saddle width required to product number. Ex. KGLT3_H=16_SA=5-1/2"

- 1) Skewed hangers with skews greater than 15° may have all joist nailing on outside flange.
 - 2) Sloped or sloped / skewed hangers with slopes greater than 15° may have additional joist nails.
 - 3) Skewed hangers typically require a bevel cut however, a square cut option may be available as a custom when requested.
 - 4) Sloped top flanges with slopes greater than 15° may have additional header nails.
- New products or updated product information are designated in **blue font**.

KGLS / KGLST / KHGLS / KHGLST Glulam Saddle Hangers

KGLS – Saddle hanger

KGLST – Saddle hanger with seismic straps

KHGLS – Heavier version of KGLS

KHGLST – Heavier version of KGLST

Materials: Top flange - 3 gauge; Stirrup - 7 gauge

Finish: Primer

Options: See KGLS / KHGLS Specialty Options Chart on page 239

Codes: IBC, FL, LA

Installation:

- Use all specified fasteners. See Product Notes, page 18.
- Loads and nail schedule apply to each saddle hanger stirrup.
- **Minimum header height is 8-1/2" for the KGLS; 8-1/2" for the KGLST; 10-1/2" for the KHGLS, and 10-1/2" for the KHGLST.**
- Beam height dimension (H) must be specified when ordering.
- **KGLST** and **KHGLST** models include seismic straps which must be installed with (3) 3/4" thru-bolts in each supported member and (2) 3/4" thru-bolts into the supporting beams.
- See welded installation chart on page 325.

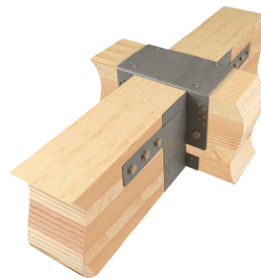

Typical KHGLST installation

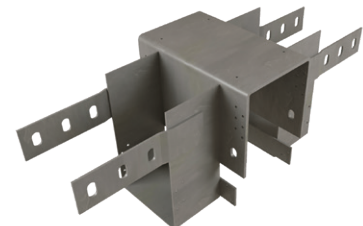

KHGLST

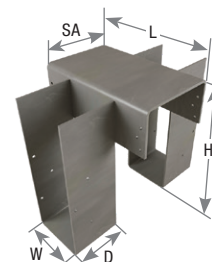

KGLS

Copyright © 2022 MiTek Industries, Inc. All Rights Reserved

Continued on next page

Supported Glulam Beam Size (in)	MiTek Stock No.	Ref. No.	Dimensions (in) ⁴					Fastener Schedule								Allowable Loads (Lbs.) ¹					Code Ref.
			W	H ⁴	D	L	SA	Header				Joist				F _C = 560 psi			Uplift 160%	Tension 160%	
								Wood Screws ^{1,3}		Bolts		Wood Screws ^{1,3}		Bolts		Floor	Roof				
								Qty	Type	Qty	Dia (in)	Qty	Type	Qty	Dia (in)	100%	115%	125%			
3-1/8	KGLS35	GLS3-5	3-1/4	specify	5	6	5-1/4	6	WS3	--	--	6	WS3	--	--	11070	11420	11650	2320	--	IBC, FL, LA
	KGLST35	--	3-1/4		6-1/2	10	5-1/4	6	WS3	2	3/4	6	WS3	3	3/4	13695	14045	14275	2320	15310	
	KGLS37	GLS3-7	3-1/4		5	6	6-7/8	6	WS3	--	--	6	WS3	--	--	11070	11420	11650	3715	--	
	KGLST37	--	3-1/4		6-1/2	10	6-7/8	6	WS3	2	3/4	6	WS3	3	3/4	13695	14045	14275	3715	15310	
	KGLS39	GLS3-9	3-1/4		5	6	8-7/8	6	WS3	--	--	6	WS3	--	--	11070	11420	11650	3715	--	
	KGLST39	--	3-1/4		6-1/2	10	8-7/8	6	WS3	2	3/4	6	WS3	3	3/4	13695	14045	14275	3715	15310	
5-1/8	KGLS55	GLS5-5	5-1/4	specify	5	9	5-1/4	6	WS3	--	--	6	WS3	--	--	15655	16065	16340	3715	--	
	KGLST55	--	5-1/4		6-1/2	12	5-1/4	6	WS3	2	3/4	6	WS3	3	3/4	19960	20370	20645	3715	15310	
	KGLS57	GLS5-7	5-1/4		5	9	6-7/8	6	WS3	--	--	6	WS3	--	--	16670	17020	17250	3715	--	
	KGLST57	--	5-1/4		6-1/2	12	6-7/8	6	WS3	2	3/4	6	WS3	3	3/4	20975	21325	21555	3715	15310	
	KHGLS5	HGLS5	5-1/4		6-1/2	12	specify	14	WS3	--	--	8	WS3	--	--	21750	22215	22525	4955	--	
	KHGLST5	--	5-1/4		6	12	specify	14	WS3	2	3/4	8	WS3	3	3/4	20315	20780	21090	4955	15310	
6-3/4	KGLS77	GLS7-7	6-7/8	specify	5	12	6-7/8	6	WS3	--	--	6	WS3	--	--	21220	21570	21800	3715	--	
	KGLST77	--	6-7/8		6-1/2	12	6-7/8	6	WS3	2	3/4	6	WS3	3	3/4	25420	25830	26105	3715	15310	
	KGLS79	GLS7-9	6-7/8		5	12	8-7/8	6	WS3	--	--	6	WS3	--	--	21220	21570	21800	3715	--	
	KGLST79	--	6-7/8		6-1/2	12	8-7/8	6	WS3	2	3/4	6	WS3	3	3/4	26890	27240	27470	3715	15310	
	KHGLS7	HGLS7	6-7/8		6	12	specify	14	WS3	--	--	8	WS3	--	--	23195	24155	24795	4955	--	
	KHGLST7	--	6-7/8		6-1/2	14	specify	14	WS3	2	3/4	8	WS3	3	3/4	25995	26955	27595	4955	15310	
8-3/4	KHGLS9	HGLS9	8-7/8	specify	6	12	specify	14	WS3	--	--	8	WS3	--	--	23195	24155	24795	4955	--	
	KHGLST9	--	8-7/8		6-1/2	16	specify	14	WS3	2	3/4	8	WS3	3	3/4	28975	29755	30395	4955	15310	

- 1) Allowable loads and fastener schedules apply to each side of the saddled hanger.
- 2) Minimum header height is 8-1/2" for the KGLS and KGLST; 10-1/2" for the KHGLS and KHGLST.
- 5) MiTek's WS3 structural wood screws are 1/4" dia. x 3" long and are included with hangers.
- 4) Hangers with seismic straps may require a minimum joist depth. Consult MiTek for additional information.

KGLS / KHGLS Specialty Options Chart – refer to Specialty Options pages 320 and 322-323 for additional details

Option	Skewed ^{1,3}	Sloped Seat ²	Sloped / Skewed ^{1,2}	Sloped Top Flange ⁴	Top Flange Offset	Saddle
Range	1° to 50°	1° to 45°	See Sloped Seat and Skewed	0° to 30°	May not be skewed	5" minimum saddle
Allowable Loads	KGLS – 6,500-lb Max KHGLS – 7,980-lb Max 50% of uplift load on skews greater than 15°.	KGLS – 6,500-lb Max KHGLS – 9,165-lb Max	KGLS – 5,500-lb Max KHGLS – may not be sloped / skewed.	100% of table load	50% of table load for KGLS. 45% of table load for KHGLS.	100% of table load per side
Ordering	Add <i>SK</i> , angle required, right (<i>R</i>) or left (<i>L</i>), and square cut (<i>SQ</i>) or bevel cut (<i>BV</i>) to product number. Ex. KGLS35H115_SK45R_BV	Add <i>SL</i> , slope required, and up (<i>U</i>) or down (<i>D</i>), to product number. Example: KGLS35H115_SL30D	See Sloped Seat and Skewed. Example: KGLS35H115_SK45R_BV_SL30D	Add <i>SLTF</i> , angle required, and right (<i>R</i>) or left (<i>L</i>), to product number. Example: KGLS35H115_SLTF30L	Add <i>OS</i> , and right (<i>R</i>) or left (<i>L</i>), to product number. Example: KGLS35H115_OSL	Add <i>S4</i> , and saddle width required to product number. Example: KGLS35H115_SA=5-1/2"

- 1) Skewed hangers with skews greater than 15° may have all joist fasteners on outside flange.
 - 2) Sloped or sloped / skewed hangers with slopes greater than 15° may have additional joist nails.
 - 3) Skewed hangers typically require a bevel cut however, a square cut option may be available as a custom when requested.
 - 4) Sloped top flanges with greater than 15° may have additional header nails.
- New products or updated product information are designated in **blue font**.

Supports a glulam beam off of another glulam beam. Refer to the Optional Horizontal Loading Chart for design variations.

Materials: See chart

Finish: Primer

Codes: IBC, FL, LA

Installation:

- Use all specified fasteners. See Product Notes, page 18.
- To allow for wood shrinkage, position bolts in slots away from the bearing seat.
- For dapped beams, reduce the “H” dimension by the “PT” dimension for each dap.

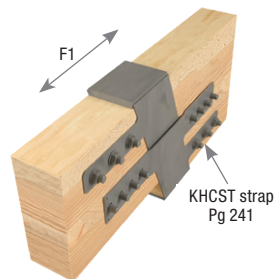

Typical KHC installation

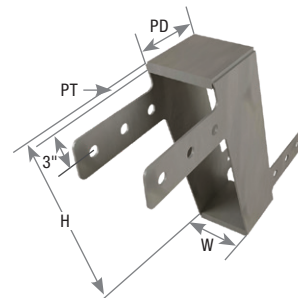

KHC3

Optional Horizontal Loading Chart

MiTek Stock No. Prefix	Ref. No.	Min. H ³ (in)	Rotation Bolts ² /Beam		Seismic Bolts ²		DF/SP Allowable Loads (Lbs.) ¹
			Qty	Dia (in)	Qty	Dia (in)	F1 160%
* KHC	HCA	8	2	3/4	--	--	--
* KHC2T	--	9	2	3/4	2	3/4	--
KHC2CT	--	12	2	3/4	2	3/4	9445
KHCCT	HCCTA	12	2	3/4	3	3/4	14170
KHC4CT	--	12	2	3/4	4	3/4	18895
* KHC3	HC3A	8	3	3/4	--	--	--
* KHC3T	--	9	3	3/4	2	3/4	--
KHC2C3T	--	12	3	3/4	3	3/4	9445
KHCC3T	--	12	3	3/4	3	3/4	14170
KHC4C3T	HC4C3TA	12	3	3/4	4	3/4	18895



KHC3 side view



KHC3 top view

- 1) Loads are based on a 5-1/8" width Douglas-Fir Larch beam.
 - 2) All bolts are 3/4", and shall meet or exceed the specifications of ASTM A 307.
 - 3) Minimum H may be less than H required for listed loads; in which case, load reductions are required.
- * When used with optional KHCST Seismic Strap, the minimum H is 12".



KHC4CT



KHC4C3T

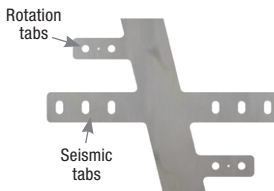

KHCCT



KHC2C3T



KHC2T



KHC3T

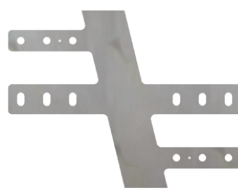

KHCC3T



KHC



KHC3



KHC2CT

Continued on next page

Allowable Download Chart

Beam Width (in)	MiTek Stock No. Suffix	Ref. No.	Steel Gauge	Dimensions (in)			H ² (in)	(2) Rotation Bolts ³ Per Beam		H ² (in)	(3) Rotation Bolts ³ Per Beam		Code Ref.
				W	PD	PT		DF/SP Allowable Download (Lbs.) ¹			DF/SP Allowable Loads (Lbs.) ¹		
								410 psi	560 psi		410 psi	560 psi	
5-1/8	55	HCA5-5	7	5-1/4	5	3/4	17-1/2	10505	14350	14	10505	14350	IBC, FL, LA
	56	HCA5-6	7	5-1/4	6	3/4	22-3/4	12610	17220	17-1/2	12610	17220	
	57	HCA5-7	7	5-1/4	7	3/4	28-3/4	14710	20090	21-3/4	14710	20090	
	59	HCA5-9	7	5-1/4	9	3/4	43-1/2	18910	25830	32	18910	25830	
6-3/4	75	HCA7-5	7	6-7/8	5	1	20-3/4	13840	18900	16	13840	18900	
	76	HCA7-6	7	6-7/8	6	1	27-1/2	16605	22680	20-3/4	16605	22680	
	77	HCA7-7	7	6-7/8	7	1	35-1/2	19375	26460	26-1/4	19375	26460	
	79	HCA7-9	7	6-7/8	9	1	55	24910	34020	40	24910	34020	
8-3/4	95	HCA9-5	7	8-7/8	5	1-1/4	24-3/4	17940	24500	18-3/4	17940	24500	
	96	HCA9-6	7	8-7/8	6	1-1/4	33-1/2	21525	29400	24-3/4	21525	29400	
	97	HCA9-7	7	8-7/8	7	1-1/4	43-3/4	25115	34300	32	25115	34300	
	99	HCA9-9	7	8-7/8	9	1-1/4	69-1/4	32290	44100	49-3/4	32290	44100	
10-3/4	115	HCA11-5	3	10-7/8	5	1-1/2	27-1/4	22040	30100	20-1/4	22040	30100	
	116	HCA11-6	3	10-7/8	6	1-1/2	37-1/4	26445	36120	27	26445	36120	
	117	HCA11-7	3	10-7/8	7	1-1/2	49-1/4	30855	42140	35-1/4	30855	42140	
	119	HCA11-9	3	10-7/8	9	1-1/2	78-1/4	39670	54180	55-1/4	39670	54180	

- 1) Allowable download shall not be further increased for duration.
- 2) The minimum height is for loads shown. For heights less than the minimum shown reduce the allowable loads in direct proportion.
- 3) All bolts are 3/4", and shall meet or exceed the specifications of ASTM A 307.

KHCST / KHCSTR Seismic Straps

Seismic straps can be installed during construction or added as a retrofit item.

Materials: See chart

Finish: Primer

Codes: IBC, FL, LA

Installation:

- Use all specified fasteners. See Product Notes, page 18.

MiTek Stock No. ³	Ref. No.	Steel Gauge	Dimensions (in)		Bolt Schedule		DF/SP Allowable Loads (Lbs.) ^{1,2}	Code Ref.
			W	L	Qty	Dia (in)		
KHCST2	--	7	3-1/2	25-5/8	4	3/4	10075	IBC, FL, LA
KHCSTR2	HCSTR2			31-5/8	6	3/4		
KHCST3	--			7	3-1/2	37-5/8		
KHCSTR3	HCSTR3	43-1/8	10			3/4		
KHCST4	--	3	3-1/2			49-1/8	12	
KHCSTR4	HCSTR4			55-1/8	14	3/4		

- 1) Allowable loads are for straps used in pairs, and are increased 60% for wind or seismic loads; no further increase shall be permitted.
- 2) Loads are based on a 5-1/8" width Douglas-Fir-Larch beam.
- 3) Seismic straps shall be used with the KHC hinge connectors.

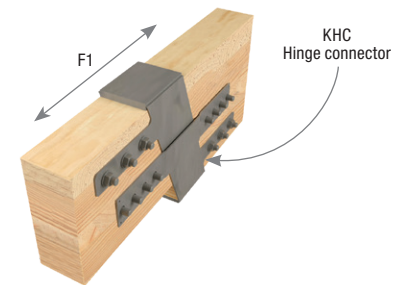

Typical KHCST installation



KHCST

TRUSS & RAFTER



TRUSS & RAFTER

244-265

Angles	255-256
Girder Tiedowns	251-254, 257-259
Hurricane Ties	256, 262-264
Moisture Barrier Plates	244
Strap Connector	265
Truss Anchors	244-250
Truss Structural Wood Screw	260-261



NOP Moisture Barrier Plates

Truss & Rafter

Moisture Barrier Plates protect the bottom chords of trusses from moisture damage caused by direct contact with concrete. These plates eliminate the need for more expensive treated wood plates.

Materials: See chart

Finish: G90 galvanizing

Installation:

- Use all specified fasteners. See Product Notes, page 18.
- Pre-attach to truss bottom chord or rafter using pre-punched prongs and/or 6d common nails to prevent wood-to-concrete contact.

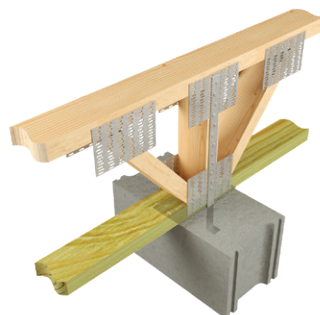

Typical NOP4 installation



NOP1

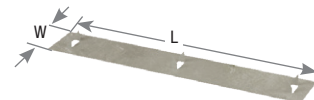

NOP2X

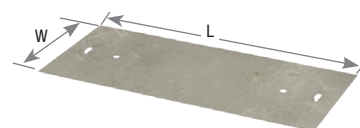

NOP4

Size	MiTek Stock No.	Ref. No.	Steel Gauge	Dimensions (in)		Fastener Schedule ¹		Code Ref.
				W	L	Qty	Type	
2x	NOP2X	TSS2, TBP8	26	1-7/16	8	--	--	--
	NOP1	--	22	1-1/2	8	2	6d	
4x	NOP4	TSS2-2	26	3-1/2	8	2	6d	

1) **NAILS:** 6d nails are 0.120" dia. x 2" long.

LPTA Embedded Truss Anchors

Low profile design attaches to 2x4 or larger bottom chords and provides uplift and lateral load resistance.

Materials: 18 gauge

Finish: G90 galvanizing

Codes: FL

Installation:

- Use all specified fasteners. See Product Notes, page 18.
- Embed LPTA 4" into concrete tie beam or masonry bond beam.
- Anchors should be spaced no closer than 8" center-to-center.
- **Moisture barrier may be required.**

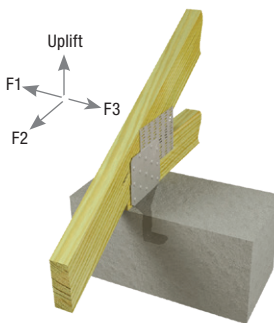

Typical LPTA perpendicular installation

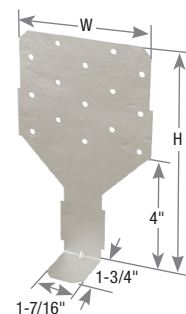

LPTA

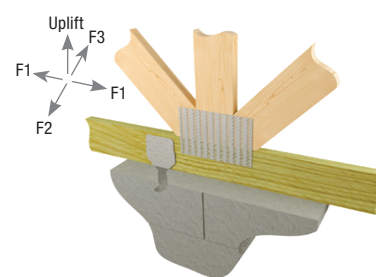

Typical LPTA parallel installation

MiTek Stock No.	Ref. No.	Steel Gauge	Dimensions (in)		Load Direction to Wall Installation	Fastener Schedule ⁵		DF/SP Allowable Loads (Lbs.) ^{1,2}				S-P-F Allowable Loads (Lbs.) ^{1,2}				Code Ref.
			W	H		Min Qty ^{3,4}	Type	Uplift 160%	F1 160%	F2 160%	F3 160%	Uplift 160%	F1 160%	F2 160%	F3 160%	
LPTA	LTA2	18	5	8-1/4	Perpendicular	10	10d x 1-1/2	1510	335	745	345	1510	280	745	345	FL
					Parallel			1470	750	1085	335	1470	750	975	280	

1) Allowable loads have been increased 60% for wind or seismic loads; no further increase shall be permitted.
 2) Connector shall be installed to fully grouted and reinforced masonry units (CMU) type S or better mortar or reinforced concrete (f'c = 2,500 psi at 28 days).
 3) Minimum quantity of fasteners to be installed. Product may have additional nail holes not needed to meet published allowable load of product.
 4) The five nail holes nearest the embedment line must be filled to achieve the lateral loads listed in the table.
 5) **NAILS:** 10d x 1-1/2 nails are 0.148" dia. x 1-1/2" long.

Copyright © 2022 MiTek Industries, Inc. All Rights Reserved

The HLPTA75 is designed and tested to provide higher lateral capacity and net uplift. Offers greater pullout resistance and is compatible with bond beam reinforcing.

Materials: 18 gauge

Finish: G90 galvanizing

Codes: See chart for code references

Patent: U.S. Patent No. 7,254,919

Installation:

- Use all specified fasteners. See Product Notes, page 18.
- Embed in concrete tie beam or masonry bond beam until the seat is resting on the surface.
- Minimum of one #7 rebar or two #5 rebars through the theoretical shear cone is required.
- Minimum spacing between anchors is 10" to achieve full design load capacities on single anchors.
- When used in a double rebar installation, concrete tie beam stirrup should be sized to accommodate connector leg placement.
- Designer shall verify connector clearance when using in conjunction with stirrups and two rebar applications.
- Verify grout is not in contact with truss member.
Moisture barrier may be required.

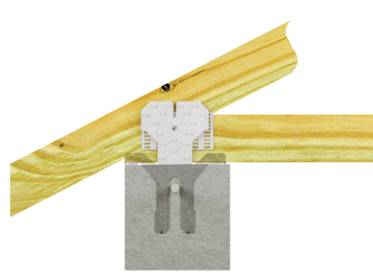

Typical HLPTA75 single rebar installation

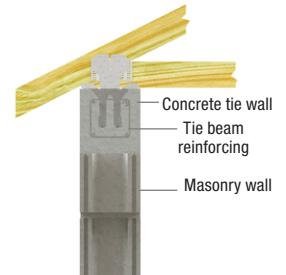

Typical HLPTA75 double rebar installation

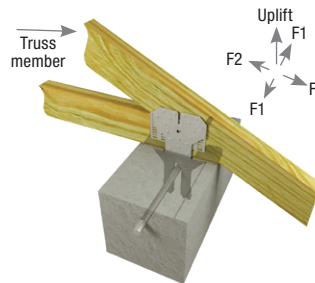

Typical HLPTA75 single anchor installation

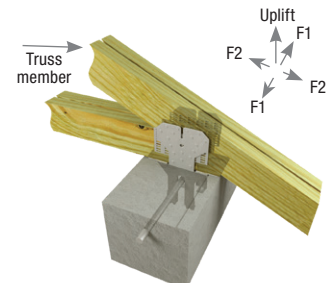

Typical HLPTA75 double anchor installation

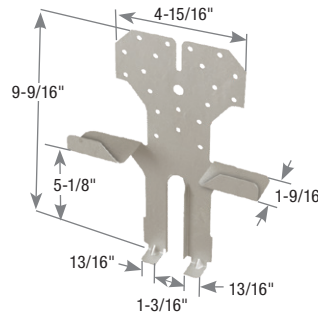

HLPTA75

MiTek Stock No.	Ref. No.	Steel Gauge	Installation Type	Fastener Schedule ³				DF/SP Allowable Loads (Lbs.) ¹			S-P-F Allowable Loads (Lbs.) ¹			Code Ref.
				Seat Plate		Truss/Rafter		Uplift 160%	F1 160%	F2 160%	Uplift 160%	F1 160%	F2 160%	
				Qty	Type	Qty	Type							
HLPTA75	--	18	Single Anchor	2	10d x 1-1/2	20	10d x 1-1/2	2125	1860	1715	2125	1860	1160	FL
			Double Anchor	--	--	40	10d x 1-1/2	3500	2040	2100	3500	2040	2100	--

1) Allowable loads have been increased 60% for wind and seismic loads; no further increase shall be permitted.

2) Connector shall be installed to fully grouted and reinforced masonry units (CMU) type S or better mortar or reinforced concrete (f'c = 2,500 psi at 28 days).

3) **NAILS:** 10d x 1-1/2 nails are 0.148" dia. x 1-1/2" long.

HTA – 16 or 18 gauge

HTAR – 16 or 18 gauge with attached moisture barrier

HHTA – 14 gauge

Materials: See chart

Finish: G90 galvanizing

Options: See chart for Corrosion Finish Options on page 247

Codes: FL

Installation:

- Use all specified fasteners. See Product Notes, page 18.
- Embed 4" into concrete tie beam or masonry bond beam.
- **For double anchor installations:** anchors should be installed on opposite sides of wood member and offset a minimum 3/4" from each other in bond beam or concrete tie beam.
- Designer may specify alternative nailing schedules. Refer to Nail Specification table on page 23 for nail shear values, load values shall not exceed published allowable loads.
- When using alternative nailing schedules, lower-most holes in strap shall be filled progressing upward towards the top of the strap.
- Straps may be installed straight or wrapped over to achieve table loads.
- Moisture barrier will be required in HTA / HHTA unless another moisture remediation method is used.

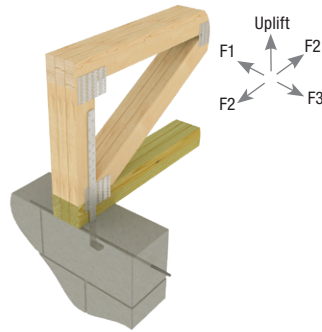

Typical HTA24-18 single anchor installation

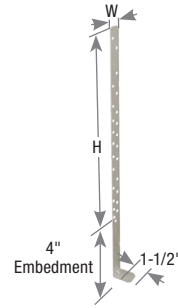

HTA24-18

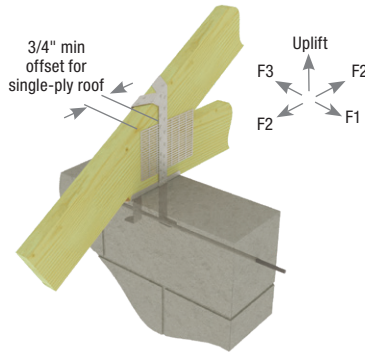

Typical HTA16 double anchor installation

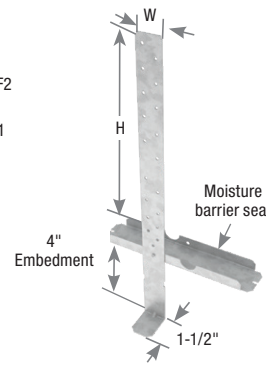

HTA16R

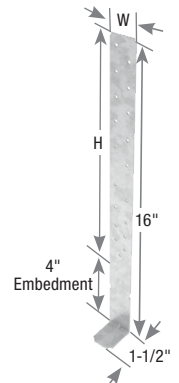

HHTA16

MiTek Stock No.	Ref. No.	GA	Dimensions (in)		Fastener Schedule		Installation Type ⁸	SP Allowable Loads (Lbs.) ^{1,2,3,4,5}						Code Ref.	
			W	H ⁷ (Out of Concrete)	Per Anchor			Masonry		Concrete		Lateral Loads			
					Min Qty. ⁶	Type ⁹		1 Ply	2 Ply	1 Ply	2 Ply	Masonry/Concrete (1 or 2 Ply)			
								Uplift 160%	Uplift 160%	Uplift 160%	Uplift 160%	F1 160%	F2 160%		F3 160%
HTA12	HETA12	16	1-1/4	8	9	10d x 1-1/2	Single Anchor	1870	1870	1870	1870	270	710	945	FL
							Double Anchor	2430	2430	2430	2430	1215	1310	1215	
HTA12R	HETA12-TSS2						Single Anchor	1870	1870	1870	1870	270	710	945	
							Double Anchor	2430	2430	2430	2430	1215	1310	1215	
HTA12-2R	HETA12-TSS2-2						Single Anchor	1870	1870	1870	1870	270	710	945	
							Double Anchor	2430	2430	2430	2430	1215	1310	1215	

- 1) Allowable loads have been increased 60% for wind or seismic loads; no further increase shall be permitted.
- 2) Allowable loads are based on anchorage to masonry/uncracked concrete.
- 3) DF Allowable Loads are identical to all SP Allowable Loads listed in the chart with the exception of the HTA single anchor installation type uplift allowable load which is limited to 1730 lbs. in both masonry and concrete.
- 4) Minimum specified masonry or concrete compressive strength, f'm is 1,500 psi and f'c is 2,500 psi at 28 days respectively.
- 5) Testing conducted and design values based on unreinforced masonry. Rebar in wall specified by others.
- 6) Minimum quantity of fasteners to be installed. Product may have additional nail holes not needed to meet published allowable load of product.
- 7) Height (H) is the distance the anchor extends out of concrete or masonry.
- 8) Double anchor installation is permitted on 1-ply roof members when anchors are offset from each other a minimum of 3/4". Do not install anchors directly back-to-back or nails will interfere with each other.
- 9) **NAILS:** 10d x 1-1/2 nails are 0.148" dia. x 1-1/2" long.

Copyright © 2022 MiTek Industries, Inc. All Rights Reserved

Continued on next page

Truss & Rafter

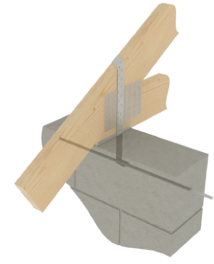
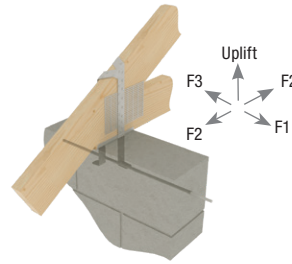
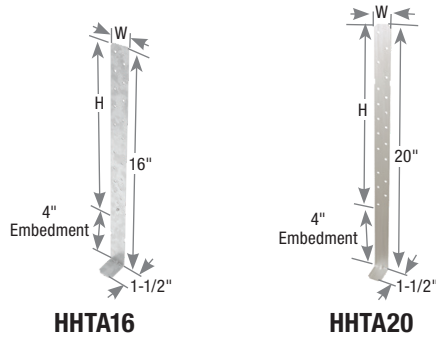

Typical HHTA20 double roof-truss installation

Typical HHTA20 single roof-truss installation

MiTek Stock No.	Ref. No.	GA	Dimensions (in)		Fastener Schedule		Installation Type ⁸	SP Allowable Loads (Lbs.) ^{1,2,3,4,5}						Corrosion Finish	Code Ref.	
			W	H ⁷ (Out of Concrete)	Per Anchor			Masonry		Concrete		Lateral Loads				
					Min Qty. ⁶	Type ^{9,10}		1 Ply	2 Ply	1 Ply	2 Ply	Masonry/Concrete (1 or 2 Ply)				
												Uplift 160%	Uplift 160%			Uplift 160%
HTA16-18	META12, META16	18	1-1/4	12	9	10d x 1-1/2	Single Anchor	1625	1625	1625	1625	250	570	835		
HTA16-18R	META16-TSS2						Double Anchor	2430	2430	2430	2430	1085	1140	1085		
HTA16	HETA16	16	1-1/4	12	9	10d x 1-1/2	Single Anchor	1870	1870	1870	1870	270	710	945		
HTA16R	HETA16-TSS2						Double Anchor	2430	2430	2430	2430	1215	1310	1215		
HTA16-2R	HETA16-TSS2-2						Single Anchor	1870	1870	1870	1870	270	710	945		
							Double Anchor	2430	2430	2430	2430	1215	1310	1215		
HHTA16	HHETA16	14	1-1/4	12	11	10d x 1-1/2	Single Anchor	2375	2375	2375	2375	270	710	945		
							Double Anchor	2650	2650	2650	2770	1215	1310	1215		
HTA20-18	META18, META20	18	1-1/4	16	9	10d x 1-1/2	Single Anchor	1625	1625	1625	1625	250	570	835		
HTA20-18R	META20-TSS2						Double Anchor	2430	2430	2430	2430	1085	1140	1085		
HTA20	HETA20	16	1-1/4	16	9	10d x 1-1/2	Single Anchor	1870	1870	1870	1870	270	710	945	FL	
HTA20R	HETA20-TSS2						Double Anchor	2430	2430	2430	2430	1215	1310	1215		
HTA20-2R	HETA20-TSS2-2						Single Anchor	1870	1870	1870	1870	270	710	945		
							Double Anchor	2430	2430	2430	2430	1215	1310	1215		
HHTA20	HHETA20	14	1-1/4	16	11	10d x 1-1/2	Single Anchor	2375	2375	2375	2375	270	710	945		
							Double Anchor	2650	2650	2650	2770	1215	1310	1215		
HTA24-18	META22, META24	18	1-1/4	20	9	10d x 1-1/2	Single Anchor	1625	1625	1625	1625	250	570	835		
HTA24-18R	META24-TSS2						Double Anchor	2430	2430	2430	2430	1085	1140	1085		
HTA24	HETA24	16	1-1/4	20	9	10d x 1-1/2	Single Anchor	1870	1870	1870	1870	270	710	945		
HTA24R	HETA24-TSS2						Double Anchor	2430	2430	2430	2430	1215	1310	1215		
HTA24-2R	HETA24-TSS2-2						Single Anchor	1870	1870	1870	1870	270	710	945		
							Double Anchor	2430	2430	2430	2430	1215	1310	1215		
HTA48R	--	16	1-1/4	42-1/2	9	10d x 1-1/2	Single Anchor	1870	1870	1870	1870	240	470	680		
HTA48-2R	HETA40-TSS2-2					10d x 1-1/2	Double Anchor	2430	2430	2430	2430	955	940	955		
							Single Anchor	1870	1870	1870	1870	240	470	680		
							Double Anchor	2430	2430	2430	2430	955	940	955		

- 1) Allowable loads have been increased 60% for wind or seismic loads; no further increase shall be permitted.
- 2) Allowable loads are based on anchorage to masonry/uncracked concrete.
- 3) DF Allowable Loads are identical to all SP Allowable Loads listed in the chart with the exception of the HTA single anchor installation type uplift allowable load which is limited to 1730 lbs. in both masonry and concrete.
- 4) Minimum specified masonry or concrete compressive strength, f'm is 1,500 psi and f'c is 2,500 psi at 28 days respectively.
- 5) Testing conducted and design values based on unreinforced masonry. Rebar in wall specified by others.
- 6) Minimum quantity of fasteners to be installed. Product may have additional nail holes not needed to meet published allowable load of product.
- 7) Height (H) is the distance the anchor extends out of concrete or masonry.
- 8) Double anchor installation is permitted on 1-ply roof members when anchors are offset from each other a minimum of 3/4". Do not install anchors directly back-to-back or nails will interfere with each other.
- 9) Stainless steel ring shank nails must be used with stainless steel connectors to achieve tabulated allowable loads.
- 10) **NAILS:** 10d x 1-1/2 nails are 0.148" dia. x 1-1/2" long.

Corrosion Finish Key

■	Stainless Steel
■	Gold Coat
■	HDG
■	Triple Zinc

The DHTA embedded truss anchor series offer high uplift capacity with a two-strap design. The straps are attached to MiTek's NOP style plate which ensures proper placement of straps while also providing a moisture barrier between the top of the wall and the truss.

Materials: DHTAx-18 – 18 gauge; DHTAx – 16 gauge

Finish: G90 galvanizing

Codes: FL

Installation:

- Use all specified fasteners. See Product Notes, page 18.
- Embed 4" into concrete tie beam or masonry bond beam.
- Designer may specify alternative nailing schedules.
- When using alternative nailing schedules, lower-most holes in strap shall be filled progressing upward towards the top of the strap.
- Straps may be installed straight or wrapped over to achieve table loads.
- Moisture barrier plate may be under bent during shipping causing attached straps to be misaligned. Install straps vertically at 90° from the horizontal top surface of the wall.

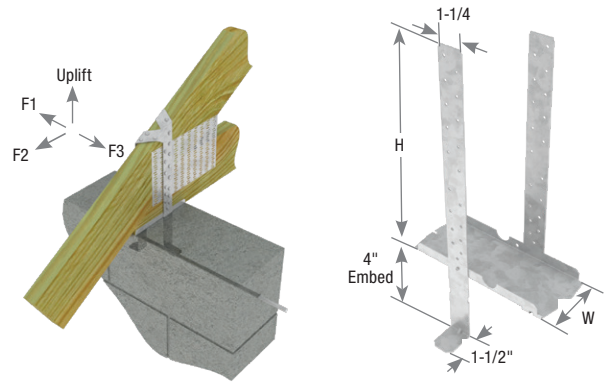

Typical DHTA 1-Ply installation



DHTA 1-Ply plan view
(DHTA 2-Ply application similar)

MiTek Stock No.	Ref. No.	Steel Gauge	Dimension (in)		Fastener Schedule		No. of Plies	SP Allowable Loads (Lbs.) ^{1,2,3,4}					Code Ref.
			W	H ⁸ (Out of Concrete)	Per Anchor			Uplift 160%		Lateral Loads ⁵			
					Min Qty. ⁶	Type ⁹		Masonry	Concrete	F1 160%	F2 160%	F3 160%	
DHTA16-18	--	18	1-3/4	12	8	10d x 1-1/2	1 Ply	2430	2430	1085	1140	1085	FL
DHTA16-18-2	--	18	3-5/16	12	8	10d x 1-1/2	2 Ply	2430	2770	1085	1140	1085	
DHTA20-18	--	18	1-3/4	16	8	10d x 1-1/2	1 Ply	2430	2430	1085	1140	1085	
DHTA20-18-2	--	18	3-5/16	16	8	10d x 1-1/2	2 Ply	2430	2770	1085	1140	1085	
DHTA24-18	--	18	1-3/4	20	8	10d x 1-1/2	1 Ply	2430	2430	1085	1140	1085	
DHTA24-18-2	--	18	3-5/16	20	8	10d x 1-1/2	2 Ply	2430	2770	1085	1140	1085	
DHTA12	--	16	1-3/4	8	8	10d x 1-1/2	1 Ply	2430	2430	1215	1310	1215	
DHTA12-2	--	16	3-5/16	8	8	10d x 1-1/2	2 Ply	2430	2770	1215	1310	1215	
DHTA16	--	16	1-3/4	12	8	10d x 1-1/2	1 Ply	2430	2430	1215	1310	1215	
DHTA16-2	--	16	3-5/16	12	8	10d x 1-1/2	2 Ply	2430	2770	1215	1310	1215	
DHTA20	DETAL20	16	1-3/4	16	8	10d x 1-1/2	1 Ply	2430	2430	1215	1310	1215	
DHTA20-2	--	16	3-5/16	16	8	10d x 1-1/2	2 Ply	2430	2770	1215	1310	1215	
DHTA24	--	16	1-3/4	20	8	10d x 1-1/2	1 Ply	2430	2430	1215	1310	1215	
DHTA24-2	--	16	3-5/16	20	8	10d x 1-1/2	2 Ply	2430	2770	1215	1310	1215	
DHTA48	--	16	1-3/4	43	8	10d x 1-1/2	1 Ply	2430	2430	955	940	955	
DHTA48-2	--	16	3-5/16	43	8	10d x 1-1/2	2 Ply	2430	2430	955	940	955	

- 1) Allowable loads have been increased 60% for wind or seismic loads; no further increase shall be permitted.
- 2) Allowable loads are based on anchorage to masonry/uncracked concrete.
- 3) DF lumber may be substituted for SP with no load reduction.
- 4) Minimum specified masonry or concrete compressive strength, f'm is 1,500 psi and f'c is 2,500 psi at 28 days respectively.
- 5) The five nail holes nearest the embedment line must be filled to achieve the lateral loads listed in the table.
- 6) Minimum quantity of fasteners to be installed. Product may have additional nail holes not needed to meet published allowable load of product.
- 7) Install (8) nails into each anchor for the DHTA installation.
- 8) Height (H) is the distance the anchor extends out of concrete or masonry.
- 9) **NAILS:** 10d x 1-1/2 nails are 0.148" dia. x 1-1/2" long.

The DTC series attaches trusses to concrete or masonry walls. Innovative seat design gives added lateral resistance while still providing a moisture barrier.

Materials: 16 gauge
Finish: G90 galvanizing
Codes: FL

Installation:

- Use all specified fasteners. See Product Notes, page 18.
- Embed 4" into concrete tie beam or masonry bond beam.
- Installations should be spaced no closer together than 8" center-to-center.
- Straps may be installed straight or wrapped over to achieve table loads.

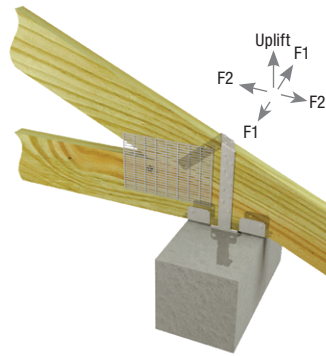

Typical DTC installation

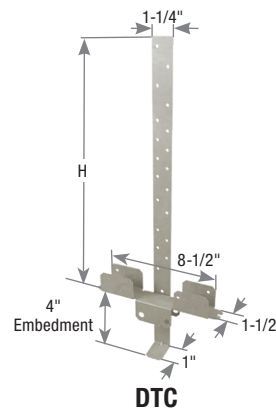

DTC

MiTek Stock No.	Ref. No.	Steel Gauge	H ⁴ (in) (Out of Concrete)	Fastener Schedule ⁵				DF/SP Allowable Loads (Lbs.) ^{1,2,3}				S-P-F Allowable Loads (Lbs.) ^{1,2,3}				Code Ref.
				Seat Plate		Truss/Rafter		Uplift 160%	F1 160%		F2 160%	Uplift 160%	F1 160%		F2 160%	
				Qty	Type	Qty	Type		Toward Strap	Away from Strap			Toward Strap	Away from Strap		
DTC	HETAL12, HETAL16, HETAL20	16	16	4	10d x 1-1/2	9	10d x 1-1/2	1825	840	1200	1290	1440	840	1200	1290	FL

1) Allowable loads have been increased 60% for wind and seismic loads; no further increase shall be permitted.
 2) Connector shall be installed to fully grouted and reinforced masonry units (CMU) type S or better mortar or reinforced concrete (f'c = 2,500 psi at 28 days).
 3) Allowable loads require a No. 5 rebar through the shear cones of the anchors.
 4) Height (H) is the distance the anchor extends out of concrete or masonry.
 5) **NAILS:** 10d x 1-1/2 nails are 0.148" dia. x 1-1/2" long.

TA – Anchors are rated for both uplift and lateral loads. They can be installed straight or field-bent around truss or rafter members. An embossed embedment line assures accurate embedment depth.

TAR – Riveted anchors provide a moisture barrier in addition to uplift and lateral resistance all in one product.

Materials: 14 gauge

Finish: G90 galvanizing

Installation:

- Use all specified fasteners. See Product Notes, page 18.
- Embed 4" into concrete tie beam or masonry bond beam.
- **For double anchor installations:** anchors should be installed on opposite sides of wood member and offset a minimum 3/4" from each other in bond beam or concrete tie beam. See increased design values in chart below.
- Designer may specify alternative nailing schedules. Refer to [Nail Specification table on page 23](#) for nail shear values, load values shall not exceed published allowable loads.
- When using alternative nailing schedules, lower-most holes in strap shall be filled progressing upward towards the top of the strap.
- Straps may be installed straight or wrapped over to achieve table loads.
- Moisture barrier will be required in installations unless another moisture remediation method is used.

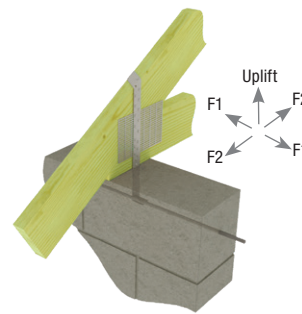

Typical TA18 installation

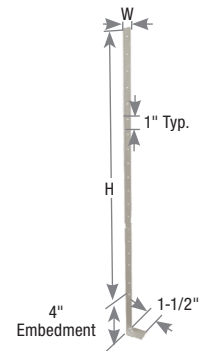

TA18

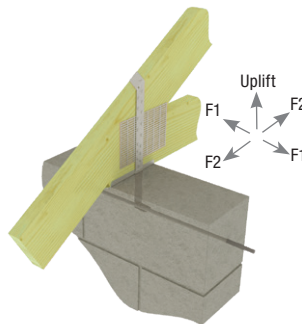

Typical TA16R installation

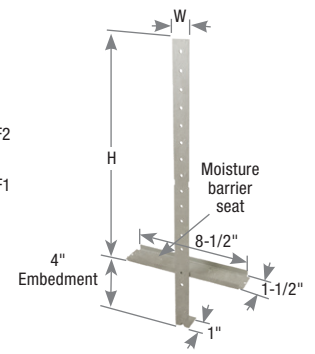

TA20R

MiTek Stock No. ⁶	Ref. No.	Steel Gauge	Dimensions (in)		Fastener Schedule		SP Allowable Loads (Lbs.) ^{1,2,3,4,5}						Code Ref.
			W	H ⁸ (Out of Concrete)	Per Anchor		Single Anchor			Double Anchor ⁹			
					Min Qty. ⁷	Type ¹¹	Uplift 160% ¹⁰	F1 160%	F2 160%	Uplift 160% ¹⁰	F1 160%	F2 160%	
TA12	--	14	1	6-3/4	5	10d x 1-1/2	990	245	335	1980	490	670	--
TA14	--	14	1	8-3/4	7	10d x 1-1/2	1205	245	335	2410	490	670	
TA14R	--	14	1	8-3/4	7	10d x 1-1/2	1205	245	335	2410	490	670	
TA16	--	14	1	10-3/4	8	10d x 1-1/2	1205	245	335	2410	490	670	
TA16R	--	14	1	10-3/4	8	10d x 1-1/2	1205	245	335	2410	490	670	
TA18	--	14	1	12-3/4	8	10d x 1-1/2	1205	245	335	2410	490	670	
TA18R	--	14	1	12-3/4	8	10d x 1-1/2	1205	245	335	2410	490	670	
TA20	--	14	1	14-3/4	8	10d x 1-1/2	1205	245	335	2410	490	670	
TA20R	--	14	1	14-3/4	8	10d x 1-1/2	1205	245	335	2410	490	670	
TA22	--	14	1	16-3/4	8	10d x 1-1/2	1205	245	335	2410	490	670	
TA22R	--	14	1	16-3/4	8	10d x 1-1/2	1205	245	335	2410	490	670	
TA24	--	14	1	18-3/4	8	10d x 1-1/2	1205	245	335	2410	490	670	
TA24R	--	14	1	18-3/4	8	10d x 1-1/2	1205	245	335	2410	490	670	
TA36	--	14	1	30-3/4	8	10d x 1-1/2	1205	245	335	2410	490	670	

1) Allowable loads have been increased 60% for wind or seismic loads; no further increase shall be permitted.
 2) Allowable loads are based on anchorage to masonry/uncracked concrete.
 3) DF Allowable Loads are identical to all SP Allowable Loads listed in the chart.
 4) Minimum specified masonry or concrete compressive strength, f'm is 1,500 psi and f'c is 2,500 psi at 28 days respectively.
 5) Allowable loads require a No. 4 rebar through the shear cones of the anchors.
 6) "R" after TA models indicates truss anchors with riveted moisture barrier as in TA12R.
 7) Minimum quantity of fasteners to be installed. Product may have additional nail holes not needed to meet published allowable load of product.
 8) Height (H) is the distance the anchor extends out of concrete or masonry.
 9) Double anchor installation is permitted on 1-ply roof members when anchors are offset from each other a minimum of 3/4".
 Do not install anchors directly back-to-back or nails will interfere with each other.
 10) Allowable uplift capacity for TA models installed with (4) 10d x 1-1/2" nails is 780 lbs per anchor. Lateral loads do not apply.
 11) **NAILS:** 10d x 1-1/2" nails are 0.148" dia. x 1-1/2" long.

The RFUS is a multi-purpose engineered solution for attaching trusses to concrete or masonry walls. Screw Anchor fastening eliminates mislocated cast-in-place anchor bolts and allows retrofit installations.

Materials: 10 gauge

Finish: Primer

Codes: FL

Installation:

- **Always install in pairs.**
- Use all specified fasteners. See Product Notes, page 18.
- Designer shall be responsible for design of masonry structure, including any required reinforcement.
- MiTek's WS structural wood screws are included with RFUS connector.
- For 1-ply applications, add filler block. Refer to page 287 for wood filler block installation.
- **Moisture barrier may be required.**

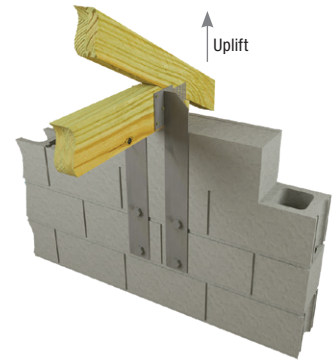

Typical RFUS installation

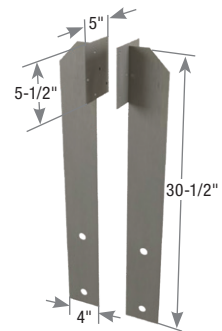

RFUS

MiTek Stock No.	Ref. No.	Steel Gauge	No. of Plies ⁶	Fastener Schedule ⁵				DF/SP Allowable Loads (Lbs.)	Code Ref.
				Rafter/Truss		Concrete/Masonry ⁴			
				Qty	Type ⁷	Qty	Screw Anchor ^{2,3}	Uplift 160% ¹	
RFUS	FGTR	10	≥ 2 Ply	12	WS3	4	3/4" x 6"	7100	FL

- 1) Uplift loads have been increased 60% for wind or seismic loads; no further increase shall be permitted.
- 2) Use DeWalt 3/4" x 6" Screw-Bolt™+; or equal, installed in accordance with manufacturer's specifications.
- 3) DeWalt 3/4" x 6" Screw-Bolt™+ are not supplied with RFUS ties. See page 45 for anchor information.
- 4) Fasteners shall be installed to fully grouted and reinforced masonry units (CMU) type S or better mortar or reinforced concrete (f'c = 2,500 psi at 28 days).
- 5) Fastener schedule is for two straps used together. The straps shall be installed in pairs.
- 6) Truss plies shall be fastened together to act as a single unit.
- 7) MiTek's WS3 structural wood screws are 1/4" dia. x 3" long and are supplied with RFUS connector.

UGTS – 2-screw anchor shorter design when space is limited

USC – 4-screw anchor high load design

Materials: 10 gauge

Finish: Primer

Codes: FL

Installation:

- Use all specified fasteners. See Product Notes, page 18.
- Place connector over truss or rafter and fasten with specified fasteners.
- Designer shall be responsible for design of masonry structure, including any required reinforcement.
- For 2-ply applications, add filler block. Refer to page 287 for wood filler block installation.
- Works with heel heights up to 14".
- **Moisture barrier may be required.**

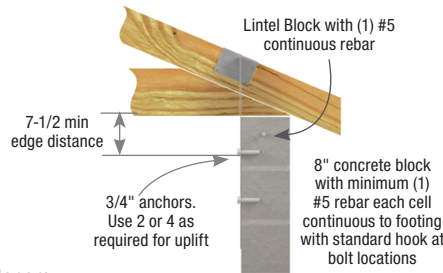

Typical USC53 installation
UGTS Similar

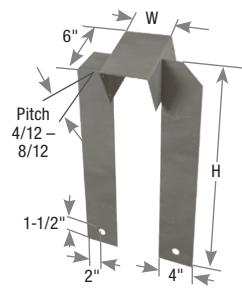

UGTS63

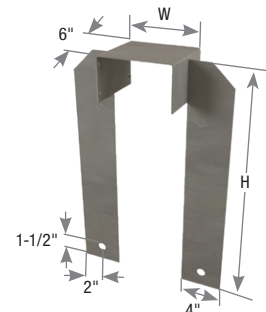

UGTS4F

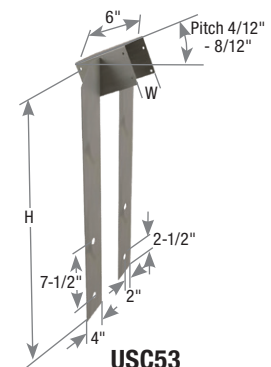

USC53

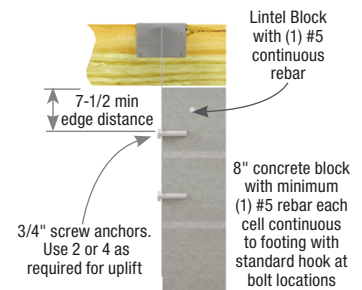

Typical USC3F installation
UGTS similar

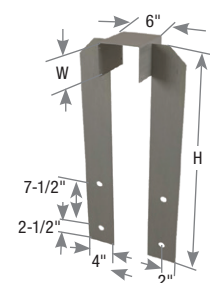

USC3F

Description	MiTek Stock No.	Ref. No.	Steel Gauge	Dimensions (in)		Fastener Schedule				DF/SP Allowable Loads (Lbs.)	Code Ref.
				W	H	Rafter/ Truss		Concrete/ Masonry Wall			
						Qty	Type ⁵	Qty	Screw Anchor ^{2,3,4}	Uplift 160% ¹	
3-Ply Flat	UGTS3F	--	10	4-3/4	23	8	16d	2	3/4" x 6"	7813	FL
	USC3F	--	10	4-3/4	30-1/2	8	16d	2	3/4" x 6"	7813 10133	
4-Ply Flat	UGTS4F	--	10	6-1/2	23	8	16d	2	3/4" x 6"	7813	
	USC4F	--	10	6-1/2	30-1/2	8	16d	2	3/4" x 6"	7813 10133	
4/12 pitch	UGTS43	--	10	4-3/4	23	8	16d	2	3/4" x 6"	7813	
	UGTS44	--	10	6-1/2	23	8	16d	2	3/4" x 6"	7813	
	USC43	--	10	4-3/4	30-1/2	8	16d	2	3/4" x 6"	7813 10133	
	USC44	--	10	6-1/2	30-1/2	8	16d	2	3/4" x 6"	7813 10133	
5/12 pitch	UGTS53	--	10	4-3/4	23	8	16d	2	3/4" x 6"	7813	
	UGTS54	--	10	6-1/2	23	8	16d	2	3/4" x 6"	7813	
	USC53	--	10	4-3/4	30-1/2	8	16d	2	3/4" x 6"	7813 10133	
	USC54	--	10	6-1/2	30-1/2	8	16d	2	3/4" x 6"	7813 10133	
6/12 pitch	UGTS63	--	10	4-3/4	23	8	16d	2	3/4" x 6"	7813	
	UGTS64	--	10	6-1/2	23	8	16d	2	3/4" x 6"	7813	
	USC63	--	10	4-3/4	30-1/2	8	16d	2	3/4" x 6"	7813 10133	
	USC64	--	10	6-1/2	30-1/2	8	16d	2	3/4" x 6"	7813 10133	
7/12 pitch	UGTS73	--	10	4-3/4	23	8	16d	2	3/4" x 6"	7813	
	UGTS74	--	10	6-1/2	23	8	16d	2	3/4" x 6"	7813	
	USC73	--	10	4-3/4	30-1/2	8	16d	2	3/4" x 6"	7813 10133	
	USC74	--	10	6-1/2	30-1/2	8	16d	2	3/4" x 6"	7813 10133	
8/12 pitch	UGTS83	--	10	4-3/4	23	8	16d	2	3/4" x 6"	7813	
	UGTS84	--	10	6-1/2	23	8	16d	2	3/4" x 6"	7813	
	USC83	--	10	4-3/4	30-1/2	8	16d	2	3/4" x 6"	7813 10133	
	USC84	--	10	6-1/2	30-1/2	8	16d	2	3/4" x 6"	7813 10133	

1) Uplift loads have been increased 60% for wind or seismic loads; no further increase shall be permitted.
 2) Use DeWalt 3/4" dia. x 6" Screw-Bolt™+; or equal, installed in accordance with manufacturer's specifications.
 3) DeWalt 3/4" dia. x 6" Screw-Bolt™+ are not supplied with ties. See page 45 for anchor information.
 4) Fasteners shall be installed to fully grouted and reinforced masonry units (CMU) type S or better mortar or reinforced concrete (f'c = 2,500 psi at 28 days).
 5) **NAILS:** 16d nails are 0.162" dia. x 3-1/2" long.

The LUGT series is an adaptable tiedown for girder trusses and offers several installation options to accommodate different framing conditions. It is an ideal retrofit solution to reinforce truss connections to transfer high wind loads to supporting walls and can be used on either concrete or CMU block walls. Sizes available for 2-ply, 3-ply and 4-ply trusses.

Materials: See chart

Finish: G90 galvanizing

Installation:

- Use all specified fasteners. See Product Notes, page 18.
- All large fastener holes must be filled with specified fasteners to achieve loads listed in the chart. Smaller fastener holes are for girder-to-stud applications (reference page 257) and do not need to be filled when used for concrete/masonry installations.
- MiTek's WS structural wood screws are included with LUGT3 and LUGT4.
- **For concrete and masonry applications, a moisture barrier may be required, check local building code.**

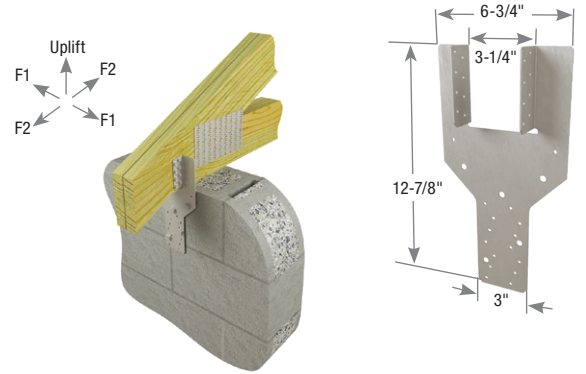

Typical LUGT2 masonry installation

LUGT2

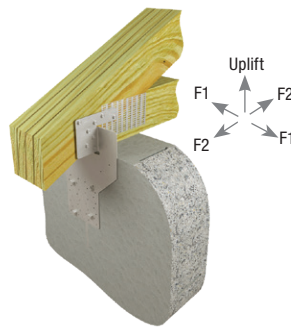

Typical LUGT4 masonry installation
(LUGT3 similar)

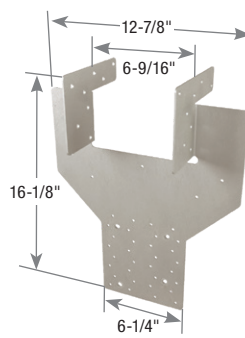

LUGT4

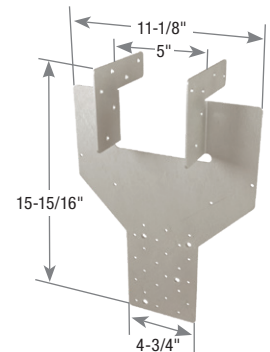

LUGT3

MiTek Stock No.	Ref. No.	Steel Gauge	No. of Plies	Fastener Schedule ²				DF/SP			S-P-F			Code Ref.
				Rafter/Truss		CMU/Concrete Wall ⁴		Allowable Loads (Lbs.) ¹			Allowable Loads (Lbs.) ¹			
				Qty	Type ^{5,6}	Qty	Screw Anchor ³	Uplift 160%	F1 160%	F2 160%	Uplift 160%	F1 160%	F2 160%	
Concrete/Masonry Installation														
LUGT2	LGT2	14	2	16	10d	5	1/4" x 3"	1655	1015	475	1460	790	475	
LUGT3	LGT3-SDS2.5	12	3	12	WS25	4	3/8" x 5"	3380	--	--	3380	--	--	--
LUGT4	LGT4-SDS3	12	4	16	WS3	4	3/8" x 5"	3380	--	--	3380	--	--	

1) Allowable loads have been increased 60% for wind or seismic loads; no further increase shall be permitted.
 2) Additional anchorage products to be designed by others.
 3) Use DeWalt Screw-Bolt™ + 1/4" dia. x 3" or 3/8" dia. x 5" screw anchors; or equal, installed in accordance with manufacturer's specification. Screw Anchors must be ordered separately, see page 44 for anchor information.
 4) Fasteners must be installed in fully grouted and reinforced concrete masonry (f'm = 1,500 psi) or reinforced concrete (f'c = 2,500 psi).
 5) MiTek's WS25 structural wood screws are 1/4" dia. x 2-1/2" long (supplied with LUGT3) and WS3 structural wood screws are 1/4" dia. x 3" long (supplied with LUGT4).
 6) **NAILS:** 10d nails are 0.148" dia. x 3" long.

MUGT15 Girder Tiedown

Designed for higher uplift resistance for concrete block construction. The MUGT15 can accommodate variable truss bearing depths.

Materials: 12 gauge
Finish: G90 galvanizing
Codes: IBC, FL, LA

Installation:

- Use all specified fasteners. See Product Notes, page 18.
- When straps are wrapped over the truss, install nails in backside of truss. See MUGT15 installation diagram for minimum nail requirements into the face and on top of the truss.
- If installed straight-up with no wrap over the top of the truss, fill all nail holes.
- **Moisture barrier may be required.**

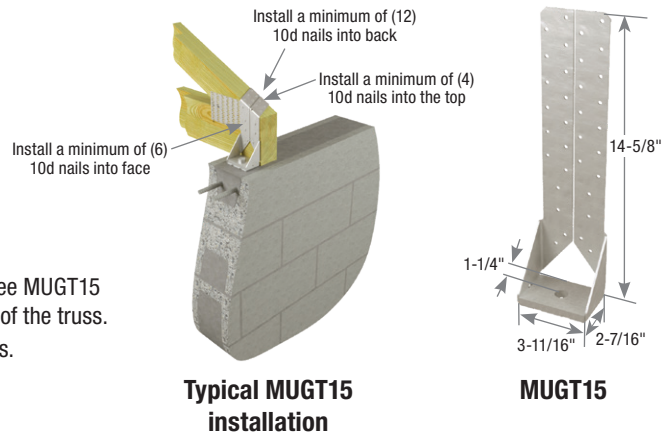

Truss & Rafter

MiTek Stock No.	Ref. No.	Steel Gauge	Mounting Condition	Fastener Schedule ³						DF/SP Allowable Loads (Lbs.)	S-P-F Allowable Loads (Lbs.)	Code Ref.
				Anchor Bolt ^{2,4}		Rafter/Truss ⁵						
				Qty	Dia (in)	Top Qty	Face Qty	Back Qty	Type	Uplift 160% ¹	Uplift 160% ¹	
Concrete/Masonry Installation												
MUGT15	MGT	12	Face-Max	1	5/8	--	28	--	10d	4240	3730	IBC, FL, LA
			Top-Min	1	5/8	4	6	12	10d	3945	3160	

1) Allowable loads have been increased 60% for wind or seismic loads; no further increase shall be permitted.
 2) MiTek CIA-GEL 7000-C may be used to anchor 5/8" threaded rod when installed into an 8" wide reinforced masonry or concrete wall. With 12" minimum embedment, the MUGT15 will achieve loads listed in table. Reinforcement is to be specified by the certified designer.
 3) Additional anchorage products to be designed by others.
 4) Designer must specify anchor bolt type, length, and embedment.
 5) **NAILS:** 10d nails are 0.148" dia. x 3" long.

HUGT Girder Tiedowns

The HUGT series high uplift girder tiedowns can be installed on beams and top chords of trusses with slopes from 0° to 34°.

Materials: 7 gauge
Finish: Primer
Codes: FL

Installation:

- Use all specified fasteners. See Product Notes, page 18.
- Install the HUGT over the beam or truss (see "W" dimension on chart for appropriate width).
- Attached members shall be designed to resist applied loads.
- **Moisture barrier may be required.**

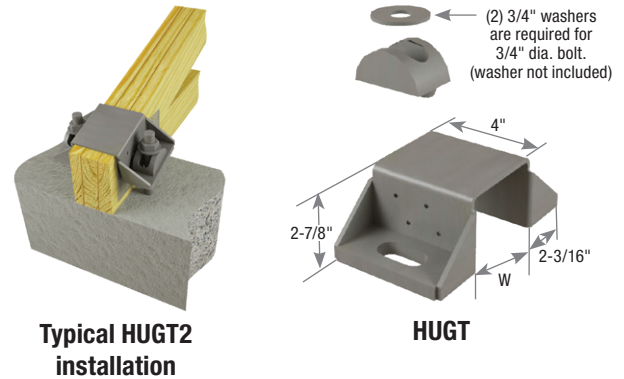

MiTek Stock No.	Ref. No.	Steel Gauge	W (in)	O.C. Dim Between Anchors (in)	Fastener Schedule ^{3,4,5}				DF/SP Allowable Loads (Lbs.) ^{1,2}	S-P-F Allowable Loads (Lbs.) ^{1,2}	Code Ref.
					Threaded Rod		Girder				
					Qty	Dia (in)	Qty	Type	Uplift 160%	Uplift 160%	
Concrete/Masonry Installation											
HUGT2	HGT-2	7	3-5/16	5-3/4	2	3/4	8	10d	9575	6925	FL
HUGT3	HGT-3	7	4-15/16	7-3/8	2	3/4	8	10d	9860	7805	
HUGT4	HGT-4	7	6-7/8	9	2	3/4	8	10d	9860	7790	

1) Allowable loads have been increased 60% for wind or seismic loads; no further increase shall be permitted.
 2) Listed loads apply where roof pitch is between 3:12 and 8:12.
 3) Additional anchorage products to be designed by others.
 4) Designer must specify anchor bolt type, length, and embedment.
 5) **NAILS:** 10d nails are 0.148" dia. x 3" long.

Copyright © 2022 MiTek Industries, Inc. All Rights Reserved

Designed for attaching gable end trusses to wood top plates and masonry walls.

For installation into grouted concrete tie beam or masonry bond beam. Provides lateral and uplift resistance.

Materials: 14 gauge
Finish: G90 galvanizing
Codes: FL

Installation:

- Use all specified fasteners. See Product Notes, page 18.
- Install MiTek's WS15 structural wood screws into the truss and drill holes for screw anchors. Install screw anchors into concrete block per manufacturer's recommendation.
- MiTek's WS15 structural wood screws and 1-3/4" screw anchors are included with HGAM10 angles.
- **Moisture barrier may be required.**

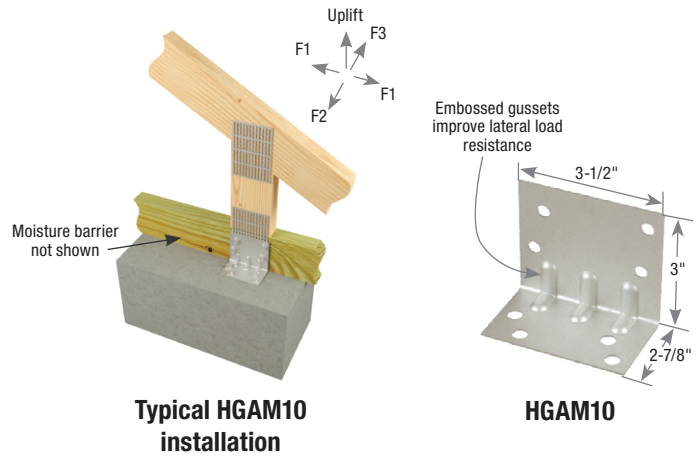

MiTek Stock No.	Ref. No.	Steel Gauge	Fastener Schedule				DF/SP Allowable Loads (Lbs.) ¹				S-P-F Allowable Loads (Lbs.) ¹				Code Ref.
			Rafter/Truss		Plate		Uplift 160%	F1 160%	F2 160%	F3 160%	Uplift 160%	F1 160%	F2 160%	F3 160%	
			Qty	Type ²	Qty	Screw Anchor ³									
HGAM10KT ⁴	HGAM10KTA	14	4	WS15	4	1/4" x 1-3/4"	980	1075	1080	980	575	630	635	575	FL

1) Allowable loads have been increased 60% for wind or seismic loads; no further increase shall be permitted.
 2) MiTek's WS15 structural wood screws are 1/4" dia. x 1-1/2" long.
 3) Use DeWalt 1/4" dia. x 1-3/4" long Screwbolt™+; or equal, installed in predrilled 1/4" hole into minimum 2,000 psi concrete compressive strength in accordance with manufacturer's specification.
 4) The HGAM10KT is a kit with (10) HGAM10 angles packaged with MiTek's WS structural wood screws and 1-3/4" screw anchors.

SHA Masonry Uplift Connectors

Connects trusses directly to masonry or concrete and features slotted base holes to ease installation.

Materials: Angle – 3 gauge; Gussets – 10 gauge
Finish: Primer

Installation:

- Use all specified fasteners. See Product Notes, page 18.
- Install directly flush to masonry wall.
- **The SHA series connectors shall be installed in pairs.**
- **Moisture barrier may be required.**

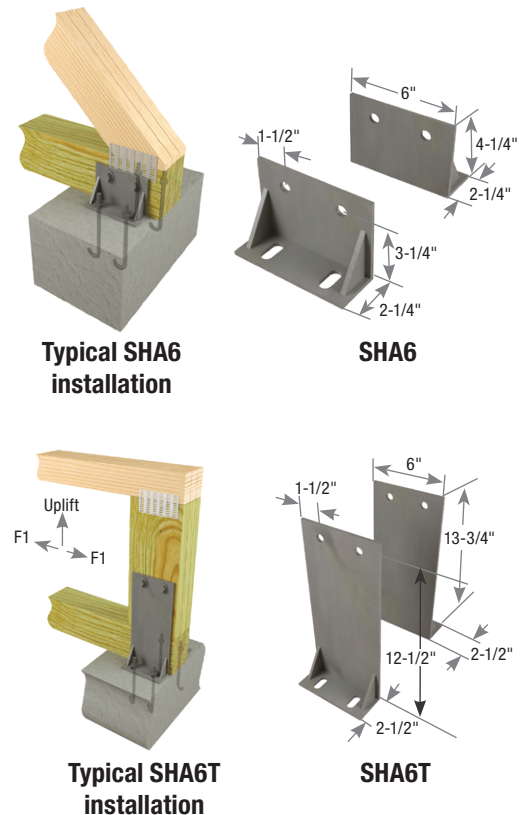

MiTek Stock No.	Ref. No.	Fastener Schedule ³				No. of Plies ⁶	DF/SP Allowable Loads (Lbs.) ^{1,2}		Code Ref.
		Concrete Wall		Rafter/Truss ⁷			Uplift 160%	F1 160%	
		Qty	Dia (in)	Qty	Bolt Dia (in)				
SHA6	--	4	1/2	2	3/4	2-Ply	3745	4005	--
						3-Ply or greater	5615	5565	
SHA6T	--	4	1/2	2	3/4	2-Ply	8370	1590	--
						3-Ply or greater	2190	2190	

1) Allowable loads have been increased 60% for wind or seismic loads; no further increase shall be permitted.
 2) Allowable loads are for a pair of SHA devices. SHAs shall be installed in pairs.
 3) Fastener schedule is for a pair of SHA devices.
 4) 1/2" x 8" J-Bolts or equivalent.
 5) Concrete compressive strength shall be 2,500 psi or greater at 28 days.
 6) Multiple ply truss shall be fastened together to act as a single unit.
 7) Bolts shall conform to ASTM A 307 or better.
 8) The designer must specify anchor bolt type, length, and embedment.

RTM Hurricane Retrofit Connector

Designed as a retrofit connector for trusses installed on top plates. Can also be used as a hold-down for a roof or floor system.

Materials: 18 gauge
Finish: G90 galvanizing
Codes: FL

Installation:

- Use all specified fasteners. See Product Notes, page 18.
- Concrete screws are not supplied with RT16M connector.
- Install concrete screws in lower two holes for Single Top Plate or Conventional Raised Foundation or Modular Home Installations.
- **Moisture barrier may be required.**

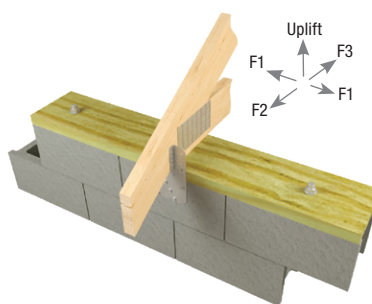

Typical RT16M top plate installation

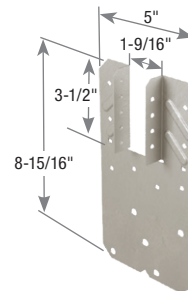

RT16M

MiTek Stock No.	Ref. No.	Steel Gauge	Fastener Schedule						DF/SP Allowable Loads (Lbs.) ¹				S-P-F Allowable Loads (Lbs.) ¹				Code Ref.
			Truss/Rafter ⁵		Top Plate ⁵		CMU/Concrete ^{2,3,4}		Uplift 160%	F1 160%	F2 160%	F3 160%	Uplift 160%	F1 160%	F2 160%	F3 160%	
			Qty	Type	Qty	Type	Qty	Screws (in)									
RT16M	HM9KT	18	9	10d x 1-1/2	--	--	4	1/4 x 1-3/4	1395	630	125	490	1225	515	125	490	FL
					4	16d	2	Tapcon	1360	630	125	490	1200	515	85	400	

- 1) Allowable loads have been increased 60% for wind or seismic loads; no further increase shall be permitted.
- 2) Install with 1/4" x 1-3/4" Tapcon® Concrete Screws in accordance to manufacturer's installation specifications.
- 3) Fasteners to be installed to fully grouted and reinforced concrete masonry.
- 4) Concrete compressive strength shall be 2,500 psi or greater at 28 days.
- 5) **NAILS:** 10d x 1-1/2 nails are 0.148" dia. x 1-1/2" long, 16d nails are 0.162" dia. x 3-1/2" long.

HGA Hurricane Gusset Angles

Designed for attaching gable end trusses to wood top plates and masonry walls.

Versatile wood-to-wood connector that satisfies high wind and seismic loading requirements.

Materials: 14 gauge
Finish: G90 galvanizing
Codes: IBC, FL, LA

Installation:

- Use all specified fasteners. See Product Notes, page 18.
- Install with MiTek's WS3 structural wood screws into top plate and MiTek's WS15 structural wood screws into the truss.
- MiTek's WS structural wood screws are included with HGA10 angles.
- **Moisture barrier may be required.**

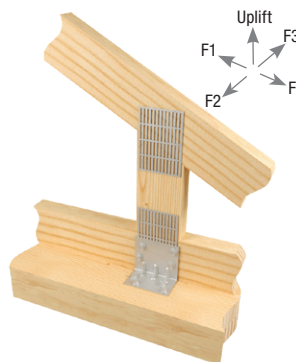

Typical HGA10 installation

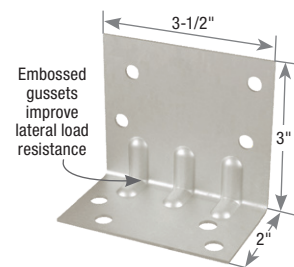

HGA10

MiTek Stock No.	Ref. No.	Steel Gauge	Fastener Schedule ²				Wall Framing	DF/SP Allowable Loads (Lbs.) ¹				S-P-F Allowable Loads (Lbs.) ¹				Code Ref.
			Rafter/Truss		Plate			Uplift 160%	F1 160%	F2 160%	F3 160%	Uplift 160%	F1 160%	F2 160%	F3 160%	
			Qty	Type	Qty	Type										
HGA10KT ³	HGA10KT	14	4	WS15	4	WS3	2x4	790	1105	340	835	515	820	250	620	IBC, FL, LA
							2x6			1065				890		

- 1) Allowable loads have been increased 60% for wind or seismic loads; no further increase shall be permitted.
- 2) MiTek's WS15 structural wood screws are 1/4" dia. x 1-1/2" long and WS3 structural wood screws are 1/4" dia. x 3" long.
- 3) The HGA10KT is a kit with (10) HGA10 angles packaged with MiTek's WS structural wood screws.

Copyright © 2022 MiTek Industries, Inc. All Rights Reserved

The LUGT series is an adaptable tiedown for girder trusses and offers several installation options to accommodate different framing conditions. It is an ideal retrofit solution to reinforce truss connections to transfer high wind loads to supporting walls. Sizes available for 1-ply, 2-ply, 3-ply and 4-ply trusses.

Materials: See chart

Finish: G90 galvanizing

Codes: See chart for code references

Installation:

- Use all specified fasteners. See Product Notes, page 18.
- All fastener holes must be filled with specified fasteners to achieve loads listed in the chart. Large fastener holes are for concrete/masonry installations (reference page 253) and do not need to be filled when used for girder-to-stud applications.
- MiTek's WS structural wood screws are included with LUGT3 and LUGT4.

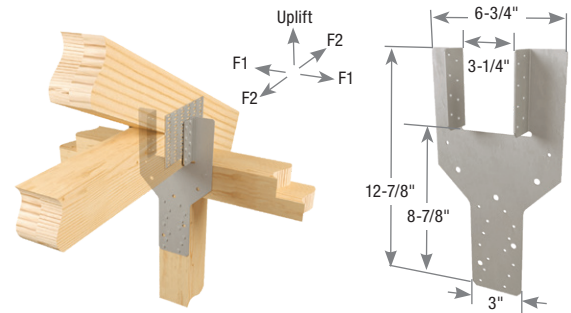

Typical LUGT2 installation

LUGT2

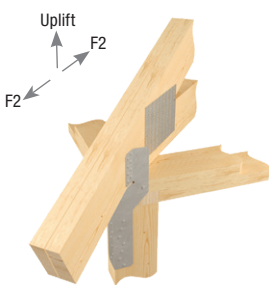

Typical LUGTC2 corner hip installation

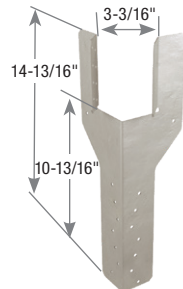

LUGTC2



Typical LUGT1 offset stud installation
(See footnote #4)

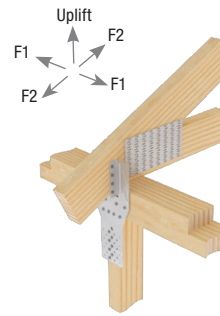

Typical LUGT1 installation

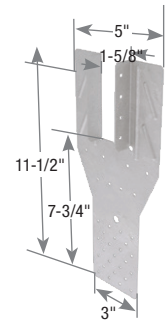

LUGT1

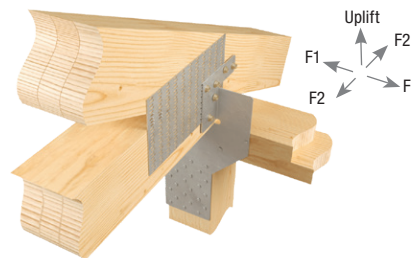

Typical LUGT3 installation
(LUGT4 similar)

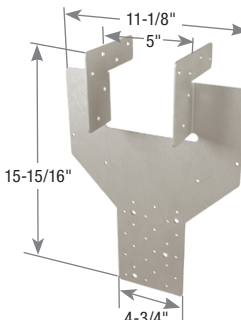

LUGT3

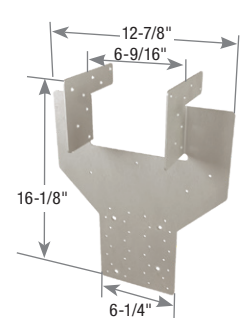

LUGT4

No. of Plies	MiTek Stock No.	Ref. No.	Steel Gauge	Fastener Schedule ^{2,3,7,8}						DF/SP Allowable Loads (Lbs.) ¹			S-P-F Allowable Loads (Lbs.) ¹			Code Ref.
				Rafter/Truss		Plate		Stud		Uplift ⁴ 160%	F1 160%	F2 160%	Uplift ⁴ 160%	F1 160%	F2 160%	
				Qty	Type	Qty	Type	Qty	Type							
Wood-to-Wood Installation																
1	LUGT1	H10S	18	8	8d x 1-1/2	8	8d x 1-1/2	7	8d x 1-1/2	1045	600	175	920	470	175	--
2	LUGT2	LGT2	14	16	10d	2	10d	14	10d	2020	880	495	1780	685	495	IBC, FL, LA
	LUGTC2	--	14	16	10d	2	10d	14	10d	2020	--	455	1780	--	355	
3	LUGT3	LGT3-SDS2.5	12	12	WS25	4	16d Sinker	24	16d Sinker	3500	1980	890	3080	1575	665	--
4	LUGT4	LGT4-SDS3	12	16	WS3	5	16d Sinker	32	16d Sinker	4725	--	--	4160	--	--	--

1) Allowable loads have been increased 60% for wind or seismic loads; no further increase shall be permitted.
 2) Additional anchorage products to be designed by others.
 3) For proper installation, the number of studs must be equal-to or greater-than the number of roof truss plies.
 4) The LUGT1 can be installed with the stud offset from the rafter a maximum of 1" (center-to-center) for a reduced allowable uplift load of 955-lb (DF/SP) and 840-lb (S-P-F).
 5) Fasteners must be installed in fully grouted and reinforced concrete masonry (f'm = 1,500 psi) or reinforced concrete (f'c = 2,500 psi).
 6) Use DeWalt Screw-Bolt™+ 1/4" dia. x 3" or 3/8" dia. x 5" screw anchors; or equal, installed in accordance with manufacturer's specification.
 7) MiTek's WS25 structural wood screws are 1/4" dia. x 2-1/2" long (supplied with LUGT3) and WS3 structural wood screws are 1/4" dia. x 3" long (supplied with LUGT4).
 8) **NAILS:** 8d x 1-1/2 are 0.131" dia. x 1-1/2" long, 10d nails are 0.148" dia. x 3" long, 16d Sinkers are 0.148" dia. x 3-1/4" long,

MUGT Girder Tiedown

Designed for higher uplift resistance for wood frame construction. The MUGT15 can accommodate variable truss bearing depths.

Materials: 12 gauge
Finish: G90 galvanizing
Codes: IBC, FL, LA

Installation:

- Use all specified fasteners. See Product Notes, page 18.
- When straps are wrapped over the truss, install nails in backside of truss. See MUGT15 installation diagram for minimum nail requirements into the face and on top of the truss.
- If installed straight-up with no wrap over the top of the truss, fill all nail holes.
- **Moisture barrier may be required.**

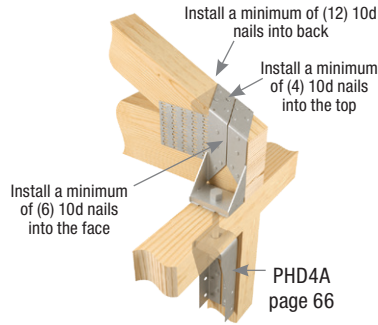

Typical MUGT15 top-min installation with PHD4A

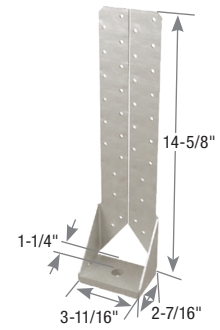

MUGT15

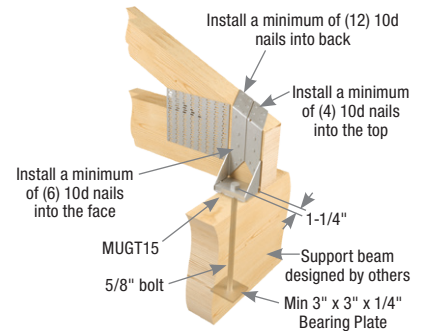

Typical MUGT15 connection to support beam

MiTek Stock No.	Ref. No.	Steel Gauge	Mounting Condition	Fastener Schedule ²						DF/SP Allowable Loads (Lbs.) Uplift 160% ¹	S-P-F Allowable Loads (Lbs.) Uplift 160% ¹	Code Ref.
				Rod/Bolt ³		Rafter/Truss ⁴						
				Qty	Dia (in)	Top Qty	Face Qty	Back Qty	Type			
Wood-To-Wood Installation												
MUGT15	MGT	12	Face-Max	1	5/8	--	28	--	10d	4240	3730	IBC, FL, LA
			Top-Min	1	5/8	4	6	12	10d	3945	3160	

1) Allowable loads have been increased 60% for wind or seismic loads; no further increase shall be permitted.
 2) Additional anchorage products to be designed by others.
 3) Designer must specify anchor bolt type, length, and holdown device.
 4) **NAILS:** 10d nails are 0.148" dia. x 3" long.

HUGT Girder Tiedowns

The HUGT series high uplift girder tiedowns can be installed on beams and top chords of trusses with slopes from 0° to 34°.

Materials: 7 gauge
Finish: Primer
Codes: FL

Installation:

- Use all specified fasteners. See Product Notes, page 18.
- Install the HUGT over the beam or truss (see "W" dimension on chart for appropriate width).
- Install (4) LBP58-TZ washers for (2) 5/8" tension rod/bolts.
- Attached members shall be designed to resist applied loads.
- **Moisture barrier may be required.**



Typical HUGT3 installation with HTT45's

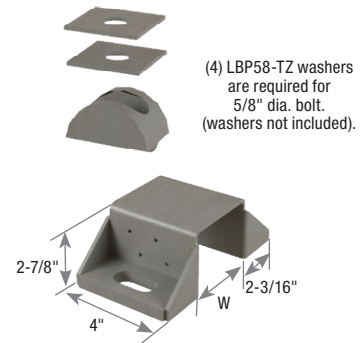

HUGT

MiTek Stock No.	Ref. No.	Steel Gauge	W (in)	O.C. Dim Between Anchors (in)	Fastener Schedule ^{3,5}						DF/SP Allowable Loads (Lbs.) ^{1,2} Uplift 160%	S-P-F Allowable Loads (Lbs.) ^{1,2} Uplift 160%	Code Ref.
					Anchor Washers		Threaded Rod		Girder				
					Qty	Type	Qty	Dia (in)	Qty	Type			
Wood-to-Wood Installation													
HUGT2	HGT-2	7	3-5/16	5-3/4	4	LBP58-TZ	2	5/8	8	10d	9575	6925	FL
HUGT3	HGT-3	7	4-15/16	7-3/8	4	LBP58-TZ	2	5/8	8	10d	9860	7805	
HUGT4	HGT-4	7	6-7/8	9	4	LBP58-TZ	2	5/8	8	10d	9860	7790	

1) Allowable loads have been increased 60% for wind or seismic loads; no further increase shall be permitted.
 2) Listed loads apply where roof pitch is between 3:12 and 8:12.
 3) Additional anchorage products to be designed by others.
 4) Designer must specify anchor bolt type, length, and holdown device.
 5) **NAILS:** 10d nails are 0.148" dia. x 3" long.

The Universal Girder Tiedown, UGTQ, is a high capacity tiedown designed to resist uplift loads on multi-ply roof trusses. The UGTQ installs with MiTek's WS structural wood screws and is fastened on one side for single connector installations or opposite sides for two connector installations. The UGTQ is available in left and right models for installation near the end of girders.

Features and Benefits:

- UGTQs may be installed as a single connector or in pairs
- May be installed elevated from top plate
- Can be installed on trusses and beams with top chord slopes up to 8/12
- May be used with holdown device, bearing plate or embedded/epoxy rod

Materials: 10 gauge

Finish: G90 galvanizing

Codes: FL

Patents: Pending

Installation:

- Use all specified fasteners.
- MiTek's WS3 structural wood screws, 1/4" dia. x 3" long, are supplied with UGTQ tiedowns.
- Left and right connectors shall be installed as shown.
- UGTQL/R shall be installed a minimum 1/2" from the end of the supported member.

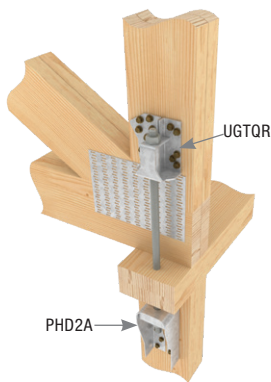
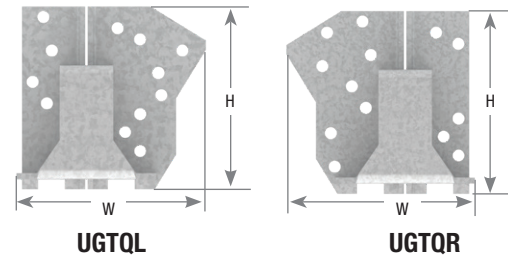
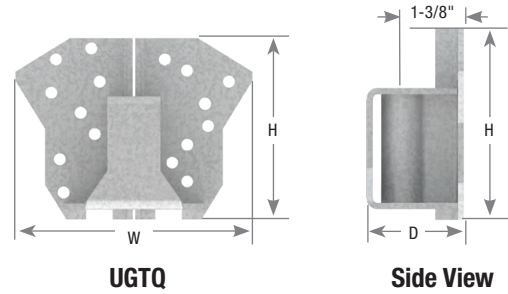

Typical UGTQ single installation with PHD2A

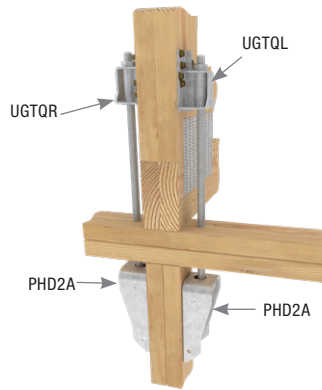

Typical UGTQL/R back-to-back installation with PHD2A

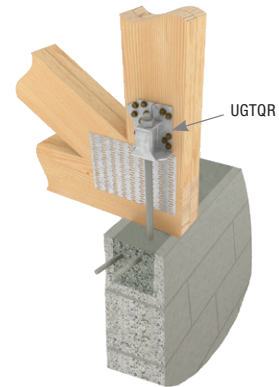

Typical UGTQR masonry installation (right shown)

MiTek Stock No.	Ref. No.	Steel Gauge	Dimensions (in)			Installation Type	Min. No. of Plies ⁵	Qty of UGTQs	Fastener Schedule				DF/SP Allowable Loads (Lbs) ^{1,2,3,6}	Code Ref.
			W	H	D				Connecting Rod		Truss/Rafter ⁵			
									Qty	Type	Qty	Type ⁴		
UGTQ	VGT	10	5-9/16	4-1/4	2-1/8	Single Installation	2	1	1	16	WS3	5175	FL	
								2	2	32		9690		
UGTQL	VGTL	10	4-1/4	4-1/4	2-1/8	Single Installation	2	1	1	12	WS3	3070		
								2	2	25		7175		
UGTQR	VGTR	10	4-1/4	4-1/4	2-1/8	Single Installation	2	1	1	13	WS3	3070		
								2	2	25		7175		

1) Allowable loads are for one UGTQ or UGTQL/R installed on one side of a 2-ply minimum truss/rafter (Qty of UGTQs listed as 1) or one UGTQ or UGTQL/R installed on each side of a 2-ply minimum truss/rafter (Qty of UGTQs listed as 2).

2) Uplift loads have been increased 60% for wind or seismic loads; no further increase shall be permitted.

3) Designer must specify the connection from the connecting rod to the supporting structure.

4) MiTek's WS3 structural wood screws are 1/4" dia. x 3" long and are included with UGTQ connectors.

5) Truss/rafter plies shall be fastened together to act as a single unit.

6) Anchorage into concrete/masonry must be designed by a designer.

New products or updated product information are designated in **blue font**.

The MiTek® WSTS Truss Structural Wood Screw can be used to resist uplift and lateral loads for truss/rafter-to-plate and stud-to-plate connections. The WSTS is tested in accordance with ICC-ES AC233 and AC13 and meets 2018 IRC and IBC code requirements.

Features and Benefits:

- Reverse thread angle on opposite ends of screw creates increased withdrawal where it's needed for higher capacity and greater uplift resistance. The shank is fully threaded along its length for installation flexibility.
- Head design countersinks out of the way of finishing materials like drywall and trim.
- Type-17 point engages the wood quickly for easier starting and driving the screw.
- Included 6" T30 Driver Bit and Angle Tool makes proper installations easier.
- WSTS can be installed on the inside eliminating difficult installations on the outside of wall.
- Included driver bit with installation guide holds screw firmly so screw may be installed with one hand.

Materials: 3/16" heat treated carbon steel

Finish: Exterior Coat

Codes: IBC, FL, LA

Patents: U.S. Patent No. 10,823,218 (WSTS screw);
U.S. Patent No. 10,639,769 (Angle Tool)

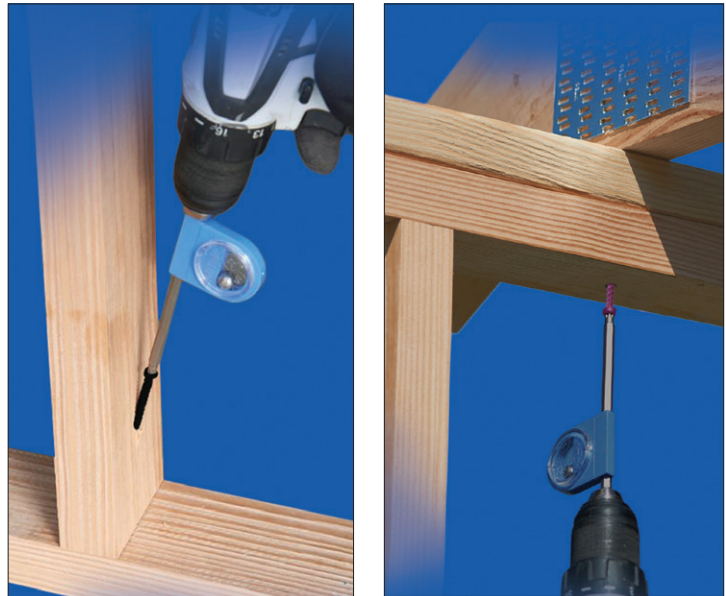

WSTS45 Installation:

- Position screw point approximately 2-3/4" from the end of the stud on the narrow or wide face. The screw point should be no closer than 1/2-in from the edge. Install the screw at an angle of 22° from vertical using the angle tool.
- Drive the WSTS screw head flush to the wood surface
- Installation angle is 15° to 25°. Use the angle tool for optimal 22° angle.

WSTS6 Installation:

- The removable angle tool comes attached to the bit. Install bit onto drill.
- **Truss aligned directly over wall stud:** Position screw point where bottom of top plate and top of stud meet. Install screw at 22° angle using the angle tool.
- **Truss between two wall studs:** On the underside of the top plate, position screw in the center of the top plate and truss bottom chord. Install the screw perpendicular through the double top plate to the truss bottom chord. Drive WSTS screw head flush to the wood surface.

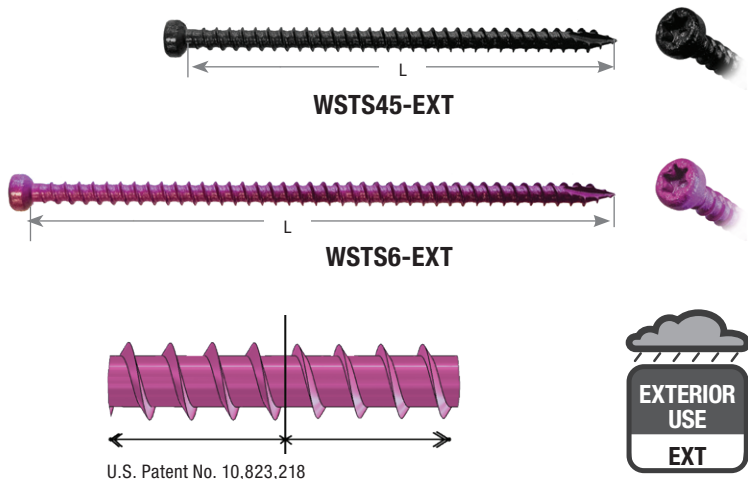

Both WSTS45 and WSTS6 products feature a reversing asymmetrical thread angle, adding withdrawal capacity

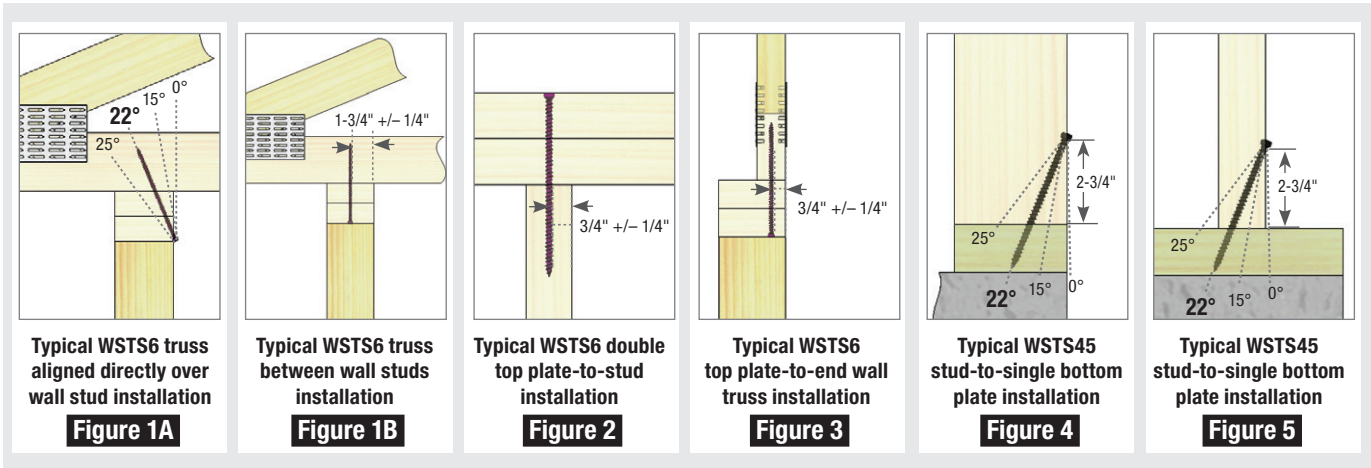

Specification Table

Size (in)	MiTek Stock No.	Ref. No.	Length (in)	Finish ¹	Installation Type ⁵	DF Allowable Loads (Lbs.) ^{2,3,4,8}			SP Allowable Loads (Lbs.) ^{2,3,4,8}			S-P-F Allowable Loads (Lbs.) ^{2,3,4,8}			Code Ref.
						Uplift ⁷ 160%	F1 ⁶ 160%	F2 ⁶ 160%	Uplift ⁷ 160%	F1 ⁶ 160%	F2 ⁶ 160%	Uplift ⁷ 160%	F1 ⁶ 160%	F2 ⁶ 160%	
0.152 x 6	WSTS6-EXT	SDWC15600	6	EXT	Figure 1A	715	225	443	802	263	496	573	177	355	IBC, FL, LA
					Figure 1B										
					Figure 2	616	--	228	637	--	257	616	--	228	
					Figure 3	847	547	336	876	547	373	662	519	235	
0.152 x 4-1/2	WSTS45-EXT	SDWC15450	4-1/2	EXT	Figure 4	372	--	277	493	--	334	296	--	231	
					Figure 5	313	--	251	380	--	266	281	--	161	

- 1) EXT = Exterior Coat.
 - 2) Allowable loads have been increased 60% for wind or seismic loads; no further increase shall be permitted.
 - 3) Allowable loads are for WSTS screws installed in accordance with installation instructions.
 - 4) When the screw is to be loaded in multiple directions simultaneously, refer to note 1 in *Design Notes* on page 18.
 - 5) Double top plates should be independently fastened together as required by applicable code.
 - 6) F1 loading is parallel to the top or bottom plate. F2 loading is perpendicular to the top or bottom plate.
 - 7) Designer must ensure that a continuous load path transfers the uplift loads to the foundation.
 - 8) Wood species shall have a minimum NDS referenced specific gravity of 0.50 for DF, 0.55 for SP, and 0.42 for SPF.
 - 9) Table loads to do not apply to installations in trusses with end grain bearing.
- Refer to MiTek's WSTS Truss and Wall Tiedown Installations technical bulletin at MiTek-US.com for additional design information.

Packaging Table

Use	Length (in)	Retail Box Offering		Bulk Offering	
		MiTek Stock No.	Box/Ctn Qty	MiTek Stock No.	Box Qty
Stud to Plate	4-1/2	WSTS45-EXTR50	5-pack/50-ea	WSTS45-EXTBP	500-ea
Plate to Truss	6	WSTS6-EXTR50	5-pack/50-ea	WSTS6-EXTBP	500-ea



- Included in each box:**
- 6" T30 Impact-Driver Compatible Bit
 - Angle Tool

These anchors tie trusses and rafters to top plates and may be used to tie wood framing members to resist uplift and lateral forces.

Truss & Rafter

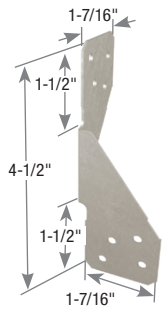

RT3A

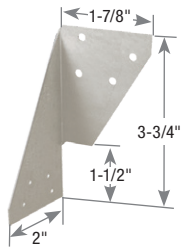

RT4
(left version shown)

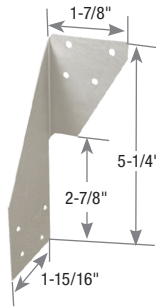

RT5
(left version shown)

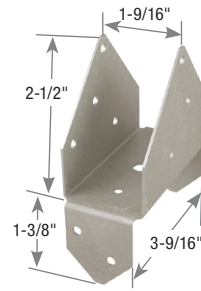

RT6

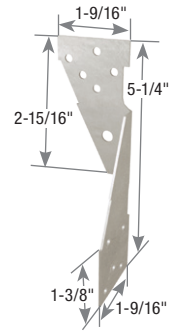

RT7
(left version shown)

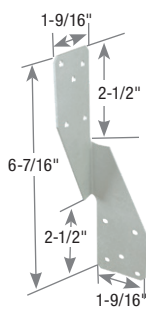

RT7A

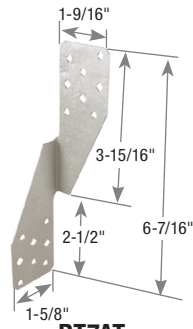

RT7AT

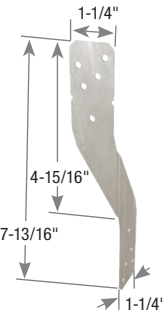

RT8A

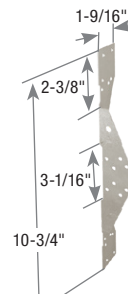

RT10

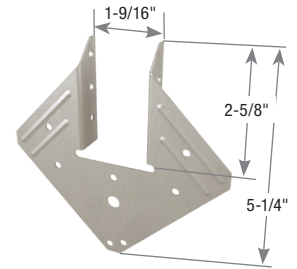

RT15

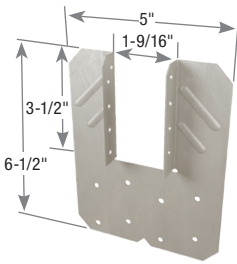

RT16A

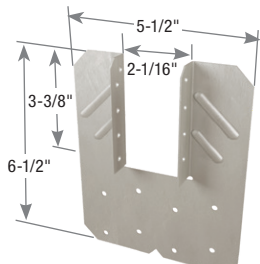

RT16AR

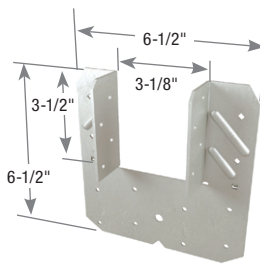

RT16-2

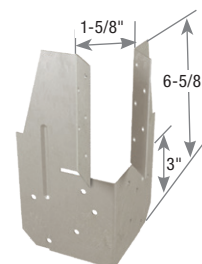

HHCP2

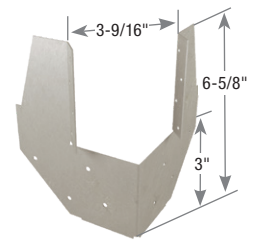

HHCP4-TZ

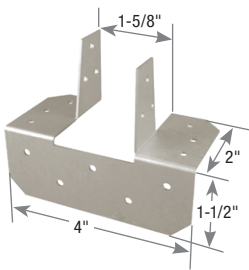

HC520

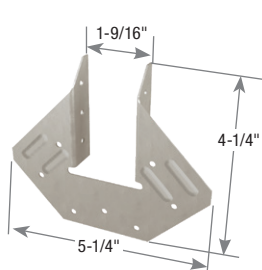

HCPRS

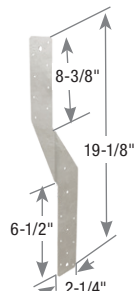

LFTA6
(left version shown)

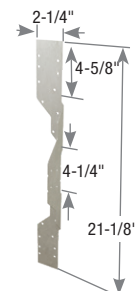

RT20

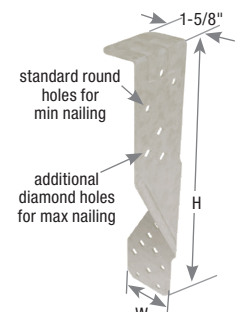

TSP

Copyright © 2022 MiTek Industries, Inc. All Rights Reserved

Continued on next page

Materials: See chart

Finish: G90 galvanizing; HHCP4-TZ – G-185 galvanizing

Options: See chart for Corrosion Finish Options

Codes: See chart for code references

Installation:

- Use all specified fasteners. See Product Notes, page 18.
- **TSP Min Nailing** – Fill all round holes.
- **TSP Max Nailing** – Fill all round and diamond holes.
- To achieve full allowable loads listed, fasteners must be installed as prescribed in the chart.
- Depending on pitch, birdsmouth notching may be required with some models to enable installers to fill all nail holes.
- Designer shall determine if solid blocking is required.
- LFTA6, RT4, RT5, and RT7 ship in equal quantities of left and right versions. Left version images shown.



Truss & Rafter

MiTek Stock No.	Ref. No.	Steel Gauge	Fastener Schedule ^{3,4,6}						DF/SP Allowable Loads (Lbs.) ¹				S-P-F Allowable Loads (Lbs.) ¹				Corrosion Finish	Code Ref.		
			Truss/Rafter		Plate		Stud		Uplift 160%	Lateral			Uplift 160%	Lateral						
			Qty	Type	Qty	Type	Qty	Type		F1 160%	F2 160%	F3 160%		F4 160%	F1 160%	F2 160%			F3 160%	F4 160%
RT3A	H3	18	4	8d x 1-1/2	4	8d	--	--	350	190	65	130	90	310	155	65	130	90	Green	IBC, FL, LA
			4	8d x 1-1/2	4	8d x 1-1/2	--	--	345	190	65	130	90	305	155	65	130	90		
RT4	--	18	4	8d x 1-1/2	4	8d	--	--	305	205	140	230	230	270	165	140	190	160	Green	IBC, FL, LA
RT5	--	18	4	8d x 1-1/2	4	8d	--	--	380	160	80	280	180	335	160	80	225	180	Green	IBC, FL, LA
RT6	HS24	18	8	8d x 1-1/2	6	8d	--	--	605	835	800	--	--	535	670	575	--	--	Green	IBC, FL, LA
RT7	--	18	5	8d x 1-1/2	5	8d	--	--	540	270	120	185	140	475	260	120	185	140	Green	IBC, FL, LA
			5	8d x 1-1/2	5	8d x 1-1/2	--	--	515					455						
RT7A	H2.5A	18	5	8d x 1-1/2	5	8d	--	--	580	285	190	135	120	510	230	190	110	120	Green	IBC, FL, LA
			5	8d x 1-1/2	5	8d x 1-1/2	--	--	630											
RT7AT	H2.5T	18	5	8d x 1-1/2	5	8d x 1-1/2	--	--	480	250	150	240	165	425	200	145	240	165	Green	IBC, FL, LA
RT8A	H8	18	5	10d x 1-1/2	5	10d x 1-1/2	--	--	750	265	100	225	150	660	265	100	225	150	Green	IBC, FL, LA
RT10	H2A	18	6	8d x 1-1/2	8	8d	6	8d	540	270	120	185	140	475	260	120	185	140	Green	IBC, FL, LA
			6	8d x 1-1/2	6	8d x 1-1/2	6	8d x 1-1/2	515	270	120	185	140	460	270	120	185	140		
RT15	H1	18	5	8d x 1-1/2	5	8d	--	--	500	490	220	415	--	440	395	220	415	--	Green	IBC, FL, LA
			5	8d x 1-1/2	5	8d x 1-1/2	--	--	580	490	220	415	--	440	395	220	415	--		
RT16A	H10A, H14	18	9	10d x 1-1/2	8	10d	--	--	1025	805	490	455	--	900	660	345	455	--	Green	IBC, FL, LA
			9	8d x 1-1/2	8	8d x 1-1/2	--	--	935	805	490	455	--	820	660	345	455	--		
RT16AR	H10AR	18	9	10d x 1-1/2	8	10d	--	--	1025	805	490	455	--	900	660	345	455	--	Green	IBC, FL, LA
RT16-2	H10A-2	18	8	8d	8	8d	--	--	1060	780	410	405	--	935	625	330	320	--	Green	IBC, FL, LA
HHCP2	HCP2	18	10	10d x 1-1/2	10	10d x 1-1/2	--	--	680	405	--	--	--	595	355	--	--	--	Green	IBC, FL, LA
HHCP4-TZ	HCP4Z	16	8	10d	8	10d	--	--	1015	380	--	--	--	885	330	--	--	--	Green	IBC, FL, LA
HC520	GBC	18	--	--	11	8d	6	8d	515	470	430	--	--	445	405	370	--	--	Green	IBC, FL, LA
			--	--	11	8d x 1-1/2	6	8d x 1-1/2	515	470	430	--	--	445	405	370	--	--		
HCPRS	--	18	6	8d	5	8d	--	--	490	525	345	570	--	315	350	275	385	--	Green	IBC, FL, LA
LFTA6 ²	H6	16	8	8d	8	8d	--	--	980	745	120	--	--	825	625	100	--	--	Green	IBC, FL, LA
			8	8d x 1-1/2	8	8d x 1-1/2	--	--	980	745	120	--	--	825	625	100	--	--		
RT20	H7	16	9	10d x 1-1/2	4	10d	9	10d x 1-1/2	1115	--	--	--	--	980	--	--	--	--	Green	IBC, FL, LA
TSP	TSP	16	3	10d x 1-1/2	3	10d x 1-1/2	--	--	465	--	--	--	--	390	--	--	--	--	Green	IBC, FL, LA
			9	10d x 1-1/2	6	10d x 1-1/2	--	--	830	365	190	210	235	700	305	160	175	200		
			9	10d x 1-1/2	6	10d	--	--	870	365	190	210	235	730	305	160	175	200		

Corrosion Finish Key

- Stainless Steel
- Gold Coat
- HDG
- Triple Zinc

1) Allowable loads have been increased 60% for wind or seismic loads; no further increase shall be permitted.
 2) LFTA6: To achieve F1 lateral loads, three nails must be installed on each side on the strap located closest to the bend line. Lateral F1 and F2 load directions do not apply to roof truss-to-top plate installations.
 3) 8d common nails may be substituted for 8d x 1-1/2 nails, and 10d common nails may be substituted for 10d x 1-1/2 nails.

4) Stainless steel ring shank nails must be used with stainless steel connectors to achieve tabulated allowable loads.
 5) **Non-identical hurricane ties are not to be combined to resist the uplift force or lateral loads at a single connection location.**
 6) **NAILS:** 8d x 1-1/2 nails are 0.131" dia. x 1-1/2" long, 8d nails are 0.131" dia. x 2-1/2" long, 10d x 1-1/2 nails are 0.148" dia. x 1-1/2" long, 10d nails are 0.148" dia. x 3" long.
 New products or updated product information are designated in **blue font**.

Continued on next page



Typical RT3A
truss/rafter to plate
installation



Typical RT4
truss/rafter to plate
installation

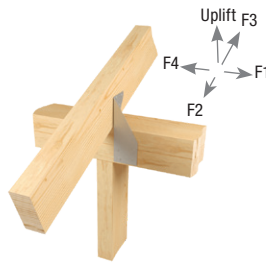

Typical RT5
truss/rafter to
double plate installation



Typical RT6
truss/rafter to
plate installation



Typical RT7
truss/rafter to
double plate installation



Typical RT7A
truss/rafter to
double plate installation

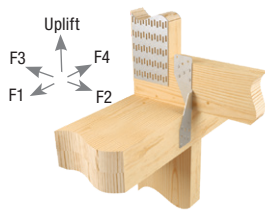

Typical RT7AT
2x4 bottom chord
installation



Typical RT8A
I-joist to double plate
installation



Typical RT10
truss/rafter to double plate
to stud installation



Typical RT15
truss/rafter to
double plate installation



Typical RT16A
truss/rafter to
double plate installation



Typical RT16AR
truss/rafter to
double plate installation

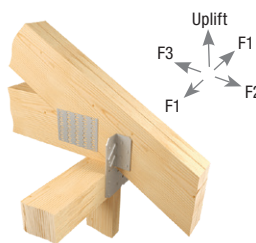

Typical RT16-2
truss/rafter to
double plate installation

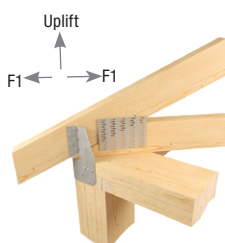

Typical HHCP2
truss/rafter to double
plate corner installation



Typical HHCP4-TZ
truss/rafter to double
plate corner installation



Typical HC520
stud to plate
installation



Typical HC520
gable brace
installation



Typical HCPRS
truss/rafter to plate
installation



Typical LFTA6
stud to plate
installation



Typical RT20
truss/rafter to double
plate to stud installation

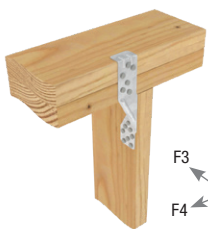

**Typical TSP top
plate installation**
(max nailing)

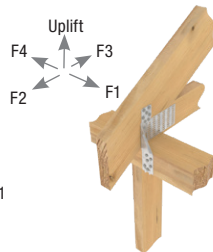

Typical TSP
truss/rafter installation
(max nailing)

Anchor installation to achieve twice the load (using two identical anchors)

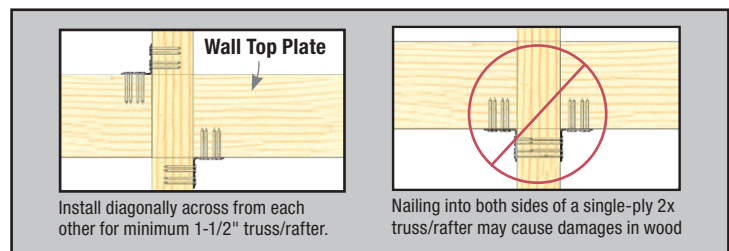

The RUSC Retro Uplift Strap Connector provides a wood-to-wood uplift connection attaching trusses with a 2x4 bottom chord to a double stud in the wall below. MiTek's WS3 structural wood screws are utilized for fast installation. The connector can be installed after roof sheathing has been installed.

Materials: 10 gauge

Finish: Primer

Codes: FL

Installation:

- Use all specified fasteners. See Product Notes, page 18.
- **The RUSC shall be installed in pairs.**
- Install on minimum 2-ply with equal wall studs centered directly below.
- Works with 2x4 bottom chord member and 2x4 wall studs.



Typical RUSC installation

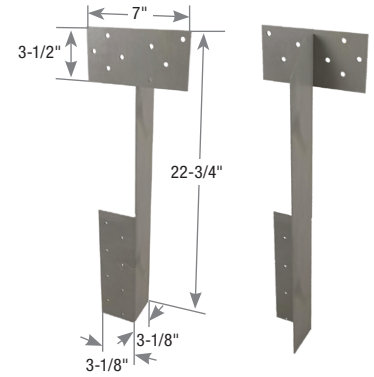

RUSC

MiTek Stock No.	Ref. No.	Steel Gauge	No. of Plies ⁶	Fastener Schedule ^{4,5}				DF/SP Allowable Loads (Lbs.) ¹		S-P-F Allowable Loads (Lbs.) ¹		Code Ref.
				Qty	Rafter/Truss	Qty	Stud	Uplift 160%		Uplift 160%		
RUSC	--	10	2-Ply or greater	16	WS3	16	WS3	6040		5225		FL

- 1) Allowable loads are for a pair of RUSC devices.
- 2) Uplift loads have been increased 60% for wind or seismic loads; no further increase shall be permitted.
- 3) Designer must specify stud or post to resist published load values.
- 4) MiTek's WS3 structural wood screws are 1/4" dia. x 3" long and are included with RUSC connectors.
- 5) Fastener schedule is for two straps used together. The RUSC shall be installed in pairs with a minimum 2-ply truss and wall stud attachment.
- 6) Truss plies shall be fastened together to act as a single unit.

PLATED TRUSS



PLATED TRUSS

268-295

Alternate Installations	287
Blocking Supports	294
Drag Strut Connectors	282
Face Mount Hangers	268-272
Field Splice Kits	295
Girder Hangers	283-286
Hip/Jack Connectors	281-282
Hoist Plates	294
Skewed Nail Plate	280
Spacers/Braces	288-289
Strap Hangers	273-279
Supplementary Bearing Plates	290
Truss Clips	291-294



MUS / HUS Slant Nail Truss Hangers

Plated Truss

The MUS / HUS hanger series offers double shear nailing. MiTek's raised dimple allows for 30° to 45° nailing through the joist into header, resulting in higher loads and less nailing.

Materials: MUS – 18 gauge; HUS – 16 gauge

Finish: G90 galvanizing

Options: See chart for Corrosion Finish Options

Codes: IBC, FL, LA

Installation:

- Use all specified fasteners. See Product Notes, page 18.
- Joist nails must be driven in at a 30° to 45° angle through the joist or truss into the header to achieve listed loads.
Slant/double shear nails must be used to achieve listed load values.
- See HUS EWP applications on page 214.



Typical HUS installation
(MUS similar)

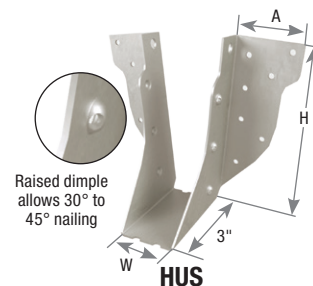

HUS

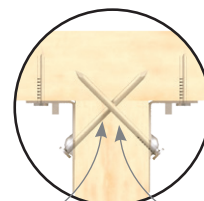

MUS

Double shear nail design features fewer nails and faster installation
Uses standard length common nails

Joist / Truss Size	MiTek Stock No.	Ref. No.	Steel Gauge	Dimensions (in)			Fastener Schedule ³				DF/SP Allowable Loads (Lbs.) ³				S-P-F Allowable Loads (Lbs.) ³				Corrosion Finish	Code Ref.
				W	H	A	Header		Truss ²		Floor	Roof	Uplift ¹	Floor	Roof	Uplift ¹				
							Qty	Type	Qty	Type							100%	115%		
2 x 6 - 8	MUS26	MUS26	18	1-9/16	5-1/16	1	6	10d	6	10d	1310	1495	1620	865	1235	1415	1530	785		IBC, FL, LA
	HUS26	HUS26	16	1-5/8	5-7/16	2	14	16d	6	16d	2760	3140	3400	2045	2430	2765	2990	1640		
2 x 8 - 10	MUS28	MUS28	18	1-9/16	7-1/16	1	8	10d	8	10d	1745	1995	2160	1230	1615	1850	2000	1090		
	HUS28	HUS28	16	1-5/8	7-3/16	2	22	16d	8	16d	4170	4745	5125	2990	3670	4035	4130	2410		
2 x 10 - 12	HUS210	HUS210	16	1-5/8	9-3/16	2	30	16d	10	16d	5455	5825	6060	4110	4235	4565	4780	3410		

1) Uplift loads have been increased 60% for wind or seismic loads; no further increase shall be permitted.
2) Nails must be driven at a 30° to 45° angle through joist or truss into header to achieve the table loads.
3) **NAILS:** 10d nails are 0.148" dia. x 3" long, 16d nails are 0.162" dia. x 3-1/2" long.
New products or updated product information are designated in **blue font**.

Corrosion Finish Key
■ Stainless Steel ■ Gold Coat
■ HDG ■ Triple Zinc

CLPBF Butterfly Hanger

The butterfly hanger's flared header flange design allows for added nailing. Excellent truss-to-truss hanger for 2x4 purlin or truss bottom chords.

Materials: 18 gauge

Finish: G90 galvanizing

Codes: IBC, FL, LA

Installation:

- Use all specified fasteners. See Product Notes, page 18.



Typical CLPBF installation

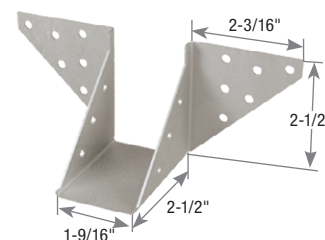

CLPBF

Joist Size	MiTek Stock No.	Ref. No.	Steel Gauge	Fastener Schedule ²				DF/SP Allowable Loads (Lbs.)				Code Ref.
				Header		Joist		Floor	Roof	Uplift ¹		
				Qty	Type	Qty	Type				100%	
2 x 4	CLPBF	--	18	12	10d	6	10d x 1-1/2	1340	1340	1340	195	IBC, FL, LA

1) Uplift loads have been increased 60% for wind or seismic loads; no further increase shall be permitted.
2) **NAILS:** 10d x 1-1/2 nails are 0.148" dia. x 1-1/2" long, 10d nails are 0.148" dia. x 3" long.

Materials: 12 gauge

Finish: G90 galvanizing

Options: See Specialty Options Chart on page 271

Codes: IBC, FL, LA

Installation:

- Use all specified fasteners. See Product Notes, page 18.
- Joist nails must be driven in at a 30° to 45° angle through the joist or truss into the header to achieve listed loads. **Slant/double shear nails must be used to achieve listed load values.**
- See EWP applications pages 215-216

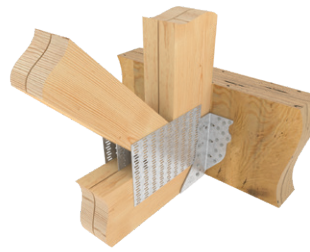

Typical THDH installation

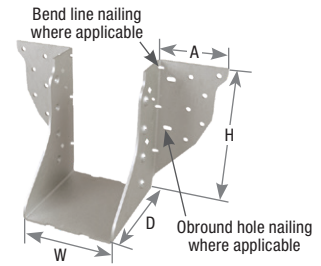

THDH

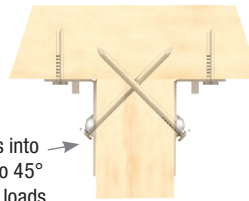

Drive joist nails into header at 30° to 45° to achieve listed loads.

Typical double shear installation

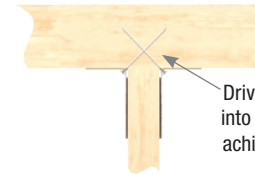

Drive bend line nails into header at 45° to achieve listed loads.

Typical bend line nail installation

Some model designs may vary from illustration shown

Joist / Truss Size	MiTek Stock No.	Ref. No.	Dimensions (in)				Fastener Schedule ³				DF/SP Allowable Loads (Lbs.)				S-P-F Allowable Loads (Lbs.)				Code Ref.				
			W	H	D	A	Header		Truss ²		Floor		Roof		Uplift ¹		Floor			Roof		Uplift ¹	
							Qty	Type	Qty	Type	100%	115%	125%	160%	100%	115%	125%	160%		100%	115%	125%	160%
2 x 6 - 8	THDH26	HGUS26	1-5/8	5-7/16	5	3-1/2	20	16d	8	16d	4375	4895	5180	2805	3850	4145	4145	2240	IBC, FL, LA				
2 x 8 - 10	THDH28	HGUS28	1-5/8	7-3/16	5	3-1/2	36	16d	12	16d	7595	8175	8175	4345	6240	6585	6585	3500					
2 x 10 - 12	THDH210	--	1-5/8	9-3/16	5	3-1/2	46	16d	16	16d	9310	9710	9710	5290	7255	7770	7870	4285					
(2) 2 x 6 - 8	THDH26-2	HGUS26-2	3-1/4	5-1/2	4	2-1/2	22	16d	8	16d	4375	4895	5180	2805	3850	4120	4120	2230					
(2) 2 x 8 - 10	THDH28-2	HGUS28-2	3-1/4	7-1/4	4	2-1/2	36	16d	10	16d	7360	8175	8175	3000	6475	6520	6520	2390					
(2) 2 x 10 - 12	THDH210-2	HGUS210-2	3-1/4	9-1/4	4	2-1/2	46	16d	12	16d	9020	9020	9020	4345	7835	7835	7835	3475					
(3) 2 x 6 - 8	THDH26-3	HGUS26-3	5-1/8	5-7/16	4	2-1/2	20	16d	8	16d	4375	4895	5180	2805	3850	4105	4105	2220					
(3) 2 x 8 - 10	THDH28-3	HGUS28-3	5-1/8	7-3/16	4	2-1/2	36	16d	12	16d	7595	8175	8175	4345	6500	6500	6500	3455					
(3) 2 x 10 - 12	THDH210-3	HGUS210-3	5-1/8	9-3/16	4	2-1/2	46	16d	16	16d	9710	9710	9710	5290	7750	7750	7750	4225					
(3) 2 x 12 - 14	THDH212-3	HGUS212-3	5-1/8	11-3/16	4	2-1/2	56	16d	20	16d	9530	9530	9530	5290	7635	7635	7635	4235					
(3) 2 x 14 - 16	THDH214-3	HGUS214-3	5-1/8	13-3/16	4	2-1/2	66	16d	22	16d	11325	11325	11325	5305	9085	9085	9085	4255					
(4) 2 x 6 - 8	THDH26-4	HGUS26-4	6-9/16	5-7/16	4	2	20	16d	8	16d	4375	4895	5180	2805	3850	4095	4095	2215					
(4) 2 x 8 - 10	THDH28-4	HGUS28-4	6-7/16	7-9/16	4	2-1/2	36	16d	12	16d	7595	8175	8175	4345	6480	6480	6480	3445					

1) Uplift loads have been increased 60% for wind or seismic loads; no further increase shall be permitted.
 2) Joist nails need to be toe nailed at a 30° to 45° angle to achieve allowable loads shown.
 3) **NAILS:** 16d nails are 0.162" dia. x 3-1/2" long.

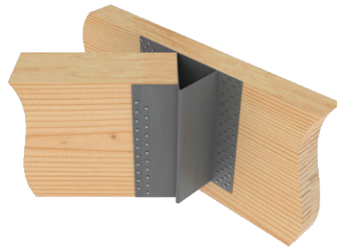

Typical THDH614-SK45RSQ installation



THDH614-SK45RSQ

Specialty Options Chart

– refer to Specialty Options pages 320-321 for additional details.

Option	Skewed ^{1,3}	Sloped Seat ²	Sloped / Skewed ^{1,2,3}
Range	1° to 45°	1° to 45°	See Sloped Seat and Skewed
Allowable Loads	85% of table allowable load. 50% of table uplift load.	85% of table allowable load	52% of table allowable load. 50% of table uplift load.
Ordering	Add <i>SK</i> , angle required, right (<i>R</i>) or left (<i>L</i>), and square cut (<i>SQ</i>) or bevel cut (<i>BV</i>) to product number. Ex. THDH410_SK45R_BV	Add <i>SL</i> , slope required, and up (<i>U</i>) or down (<i>D</i>), to product number. Ex. THDH410_SL30D	See Sloped Seat and Skewed. Ex. THDH410_SK45R_BV_SL30D

1) Skewed THDH hangers with skews greater than 15° always have all joist nailing on one side of the outside flange.

2) Sloped or sloped / skewed hangers with slopes greater than 15° may have additional joist nails.

3) Skewed hangers typically require a bevel cut however, a square cut option may be available as a custom when requested.

Inverted flange option is not available for THDH models.

The THDHQ hangers are designed to attach multi-ply girder trusses together using MiTek's WS structural wood screws for higher design load capacity. THDHQ hangers can also be used to attach structural composite lumber (SCL).

Materials: 12 gauge
Finish: G90 galvanizing
Options: See Specialty Options Chart
Codes: IBC, FL, LA

Installation:

- Use all specified fasteners.
- MiTek's WS structural wood screws are supplied with THDHQ hangers.



Typical THDHQ28-2 truss installation



Typical THDHQ28-2 SCL installation

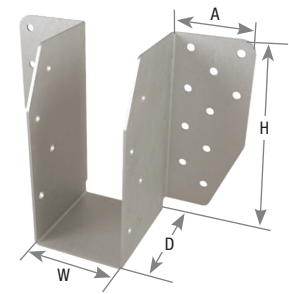

THDHQ28-2

Joist / Truss Size	MiTek Stock No.	Ref. No.	Dimensions (in)				Fastener Schedule ^{2,3}				DF/SP Allowable Loads (Lbs.)				S-P-F Allowable Loads (Lbs.)				Code Ref.			
			W	H	D	A	Supporting Member ⁵		Supported Member		Allowable Loads (Lbs.)				Allowable Loads (Lbs.)							
							Qty	Type	Qty ⁴	Type	Floor	Roof	Uplift ¹	100%	115%	125%	160%	Floor		Roof	Uplift ¹	100%
Double 2x Sizes																						
(2) 2 x 6 - 8	THDHQ26-2	--	3-5/16	5-7/16	4	1-15/16	12	WS3	4	WS3	5015	5745	5745	2055	4405	4560	4560	1630	IBC, FL, LA			
(2) 2 x 8 - 10	THDHQ28-2	--	3-5/16	7-3/16	4	2-13/16	20	WS3	8	WS3	8355	9540	9540	3645	7340	7640	7640	2920				
(2) 2 x 10 - 12	THDHQ210-2	--	3-5/16	9-3/16	4	2-13/16	28	WS3	8	WS3	10840	10880	10880	5270	8035	8475	8715	4220				
Triple 2x Sizes																						
(3) 2 x 6 - 8	THDHQ26-3	--	4-15/16	5-7/16	4	1-15/16	12	WS45	4	WS45	5015	5745	5745	2055	4405	4545	4545	1625				
(3) 2 x 8 - 10	THDHQ28-3	--	4-15/16	7-3/16	4	2-13/16	20	WS45	8	WS45	8355	9540	9540	3645	7340	7595	7595	2900				
(3) 2 x 10 - 12	THDHQ210-3	--	4-15/16	9-3/16	4	2-13/16	28	WS45	8	WS45	10880	10880	10880	5270	8665	8665	8665	4195				
Quadruple 2x Sizes																						
(4) 2 x 6 - 8	THDHQ26-4	--	6-9/16	5-7/16	4	1-15/16	12	WS6	4	WS6	5015	5745	5745	2490	4405	4535	4535	1965				
(4) 2 x 8 - 10	THDHQ28-4	--	6-9/16	7-3/16	4	2-13/16	20	WS6	8	WS6	8355	9540	9540	4530	7340	7570	7570	3595				
(4) 2 x 10 - 12	THDHQ210-4	--	6-9/16	9-3/16	4	2-13/16	28	WS6	8	WS6	10880	10880	10880	4200	8635	8635	8635	3335				
4x Sizes																						
4 x 6 - 8	THDHQ46	--	3-5/8	5-7/16	4	1-15/16	12	WS3	8	WS3	5015	5745	5745	2055	4405	4590	4590	1640				
4 x 8 - 10	THDHQ48	--	3-5/8	7-3/16	4	2-13/16	20	WS3	8	WS3	8355	9540	9540	3645	7340	7625	7625	2910				
4 x 10 - 12	THDHQ410	--	3-5/8	9-3/16	4	2-13/16	28	WS3	8	WS3	10880	10880	10880	5270	8690	8690	8690	4210				

- 1) Uplift loads have been increased 60% for wind or seismic loads; no further increase shall be permitted.
- 2) MiTek's WS3 (1/4" dia. x 3" long), WS45 (1/4" dia. x 4-1/2" long), and WS6 (1/4" dia. x 6" long) structural wood screws are included with THDHQ hangers.
- 3) MiTek's WS structural wood screws may be installed through metal truss connector plates as approved by truss designer per ANSI/TPI 1-2014 Section 7.5.3.4 and 8.9.2. Pre-drilling required through the plate using a maximum of 5/32" bit.
- 4) MiTek's WS structural wood screws specified for supported member must ALL be installed into the supported member while maintaining a minimum 5/8" edge distance where truss connector plates are not present.
- 5) When fastening to a multi-ply supporting truss: use MiTek's WS3 for 2-ply, WS45 for 3-ply and WS6 for 4-ply.

Specialty Options Chart

– refer to Specialty Options pages 320-321 for additional details.

Option	Skewed ^{1,3}	Sloped Seat ²	Sloped / Skewed ^{1,2,3}	Inverted Flange ^{4,5}
Range	1° to 45°	1° to 45°	See Sloped Seat and Skewed	One flange option available on all sizes. Two flange option available on widths ≥ 6-9/16"
Allowable Loads	100% of table allowable load. 75% of table uplift load.	100% of table allowable load	100% of table allowable load. 75% of table uplift load.	100% of table value. May not be installed into the support members endgrain.
Ordering	Add <i>SK</i> , angle required, right (<i>R</i>) or left (<i>L</i>), and square cut (<i>SQ</i>) or bevel cut (<i>BV</i>) to product number. Ex. THDHQ410_SK45R_BV	Add <i>SL</i> , slope required, and up (<i>U</i>) or down (<i>D</i>), to product number. Ex. THDHQ410_SL30D	See Sloped Seat and Skewed. Ex. THDHQ410_SK45R_BV_SL30D	<u>One flange option:</u> Add <i>IF</i> , and right (<i>R</i>) or left (<i>L</i>), to product number. Ex. THDHQ410_IFR <u>Two flange option:</u> Add <i>IF</i> , to product number. Ex. THDHQ26-3_IF

- 1) Skewed THDHQ hangers with skews greater than 15° always have all joint fasteners on one side of the outside flange.
- 2) Sloped or sloped / skewed hangers with slopes greater than 15° may have additional joist fasteners.
- 3) Skewed hangers typically require a bevel cut however, a square cut option may be available as a custom when requested. Some square cut hangers will require custom pricing due to welded back plate.
- 4) The inverted flange option is not available on skewed THDHQ hangers.
- 5) THDHQ26-3 is available with both flanges inverted.

The MSH is field adjustable. The flanges can be used in top mount, face mount, or combination installations. An open back design allows installation after a member is placed in position.

Materials: See chart

Finish: G90 galvanizing

Options: See chart for Corrosion Finish Options on pages 274-275 and Nailer Options Chart below

Codes: IBC, FL, LA

Installation:

- Use all specified fasteners. See Product Notes, page 18.
- Web stiffeners are required for I-Joist installations.

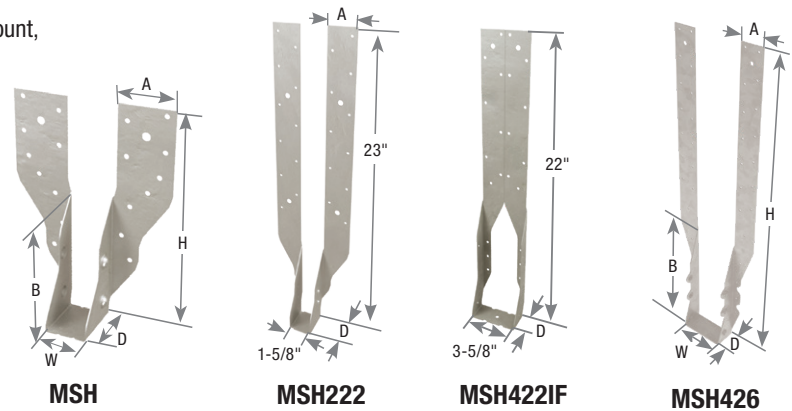

Nailer Options

– chart represents maximum allowable loads for hangers used on wood nailers. Reference page 203.

MiTek Series	Nailer Size	Fastener Schedule ²					DF/SP Allowable Loads (Lbs.) ^{1,3}	SPF Allowable Loads (Lbs.) ^{1,3}
		Nailer		Joist				
		Top Qty	Face Qty	Type	Qty	Type		
MSH (18 gauge)	2X	4	--	10d x 1-1/2"	4	10d x 1-1/2"	1245	1045
	3X	4	--	10d x 1-1/2"	4	10d x 1-1/2"	1245	1045
	(2) 2X	4	2	10d	4	10d x 1-1/2"	1950	1540
	4X	4	2	10d	4	10d x 1-1/2"	1950	1540
MSH (16 or 14 gauge)	2X	4	2	10d x 1-1/2"	6 ⁴	10d x 1-1/2"	2355	1860
	3X	4	2	10d x 1-1/2"	6 ⁴	10d x 1-1/2"	2355	1860
	(2) 2X	4	2	16d x 2-1/2"	6	10d x 1-1/2"	2080	1745
	4X	4	2	16d x 2-1/2"	6	10d x 1-1/2"	2080	1745

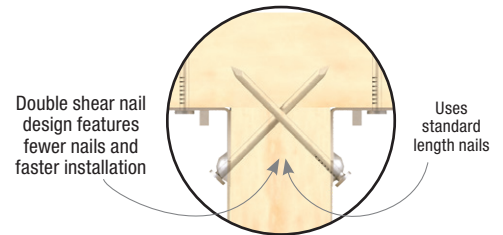

- 1) Listed loads shall not be increased.
 - 2) **NAILS:** 10d x 1-1/2" nails are 0.148" dia. x 3" long, 10d nails are 0.148" dia. x 3" long, 16d x 2-1/2" nails are 0.162" dia. x 2-1/2" long.
 - 3) **Values in the table apply to standard top mount hangers without slope, skew or any other speciality options.**
 - 4) Refer to load table on page 274 or 275 for gauge and joist nail quantity of desired MSH hanger.
- New products or updated product information are designated in **blue** font.

Mounting Conditions

Face Max	Top-Max	Top-Min	Combination Face-Max / Top-Max
<p>All header nails used should be driven into the wide face of the header.</p> <p>Typical MSH face-max installation</p>	<p>The hanger is installed in a top mount condition with at least six lowest header face nail holes filled, and four top flange nails filled. Refer to Table 1 below for minimum top flange length requirements.</p> <p>Typical MSH top-max installation</p>	<p>The hanger is installed in a top mount condition with at least the top two header face nail holes filled, and four top flange nail holes filled. Refer to Table 1 below for minimum top flange length requirements. The joist nails shall be installed straight into the joist for all models.</p> <p>Typical MSH top-min installation</p>	<p>Face-Max values apply for the entire connection. Follow fastening directions for the applicable mounting condition for each individual flange strap.</p> <p>Typical MSH combination installation</p>

Table 1

Minimum Top Flange Length for Top Mount Installations ¹											
7/8"	1-1/8"	1-3/8"	1-1/2"	1-3/4"	1-7/8"	2"	2-3/16"		2-5/8"	2-3/4"	2-13/16"
MSH426	MSH29	MSH2322-2	MSH422-2	MSH426-2	MSH1713	MSH424	MSH222	MSH222-2	MSH218-2	MSH218	MSH213
MSH426IF	--	MSH2622-2	MSH422-2IF	--	--	--	MSH1722	MSH422IF	--	MSH413	--
--	--	--	--	--	--	--	MSH2322	MSH2022	--	MSH418	--
--	--	--	--	--	--	--	MSH322	--	--	MSH422	--

1) Total hanger height will be reduced by the top flange length. Carried member height must be accounted for accordingly.

Continued on next page

Plated Truss Chart

Joist Material & Width	MiTek Stock No.	Ref. No.	Steel Gauge	Dimensions (in)					Mounting Condition	Fastener Schedule ²					DF/SP Allowable Loads (Lbs.)				S-P-F Allowable Loads (Lbs.)				Corrosion Finish	Code Ref.				
				W	D	H	A	B		Header		Joist			Floor		Roof		Uplift ¹		Floor				Roof		Uplift ¹	
										Top Qty	Face Qty	Type	Qty	Type	100%	115%	125%	160%	100%	115%	125%	160%			100%	115%	125%	160%
2x Lumber or Trusses	MSH29	THA29	18	1-5/8	2-1/4	8-3/4	2-7/16	5	face-max	--	18	10d	4	10d	2550	2640	2640	715	2115	2115	2115	575						
									top-max	4	6	10d	4	10d	2945	2945	2945	715	2200	2315	2355	570						
									top-min	4	2	10d	4	10d x 1-1/2	2390	2390	2390	--	1855	1890	1890	--						
	MSH213	THA213	18	1-5/8	2-1/4	12-3/4	2-3/8	5	face-max	--	20	10d	4	10d	2640	2640	2640	715	2115	2115	2115	575						
									top-max	4	6	10d	4	10d	2945	2945	2945	715	2200	2315	2355	570						
									top-min	4	2	10d	4	10d x 1-1/2	2390	2390	2390	--	1855	1890	1890	--						
	MSH218	THA218	18	1-5/8	2-1/4	16-3/4	2-7/16	5	face-max	--	26	10d	4	10d	2640	2640	2640	715	2115	2115	2115	575						
									top-max	4	6	10d	4	10d	2945	2945	2945	715	2200	2315	2355	570						
									top-min	4	2	10d	4	10d x 1-1/2	2390	2390	2390	--	1855	1890	1890	--						
	MSH222	THAI222	18	1-5/8	1-3/4	23	1-13/16	10-13/16	face-max	--	22	10d	4	10d x 1-1/2	2120	2190	2230	715	1540	1595	1635	575						
									top-max	4	6	10d	4	10d x 1-1/2	2120	2190	2230	715	1540	1595	1635	575						
									top-min	4	2	10d	4	10d x 1-1/2	2120	2190	2230	--	1540	1595	1635	--						
2-1/2" wide Floor Trusses	MSH322	THAI322	18	2-9/16	1-3/4	22-1/2	1-13/16	10-3/8	face-max	--	22	10d	4	10d x 1-1/2	2350	2350	2350	715	1875	1875	1875	570						
									top-max	4	6	10d	4	10d x 1-1/2	3240	3240	3240	715	2330	2385	2425	570						
									top-min	4	2	10d	4	10d x 1-1/2	2395	2395	2395	--	1895	1895	1895	--						
(2) 2x Lumber or Trusses	MSH218-2	THA218-2	16	3-1/8	1-3/4	17-3/4	1-13/16	10-1/16	face-max	--	16	10d	4	10d	2000	2245	2420	675	1760	1975	2130	540						
									top-max	4	6	10d	4	10d	3485	3575	3640	675	2520	2600	2660	540						
									top-min	4	2	10d	4	10d	2435	2435	2435	--	2080	2105	2125	--						
	MSH222-2	THA222-2	16	3-1/8	1-3/4	22-1/4	1-13/16	10-1/16	face-max	--	22	10d	4	10d	2750	3085	3330	675	2420	2675	2675	540						
									top-max	4	6	10d	4	10d	3485	3575	3640	675	2520	2600	2660	540						
									top-min	4	2	10d	4	10d	2435	2435	2435	--	2080	2105	2125	--						
3-1/2" wide Floor Trusses	MSH413	THA413	16	3-9/16	1-3/4	14	1-7/8	7-5/8	face-max	--	14	10d	6	10d	2340	2640	2855	1815	2055	2325	2510	1450						
									top-max	4	6	10d	6	10d	3875	3875	3875	1815	3035	3090	3090	1450						
									top-min	4	2	10d	6	10d	2530	2530	2530	--	2000	2000	2000	--						
	MSH418	THA418	16	3-9/16	1-3/4	17-1/2	1-7/8	7-5/8	face-max	--	18	10d	6	10d	2840	3200	3460	1815	2495	2815	3040	1450						
									top-max	4	6	10d	6	10d	3875	3875	3875	1815	3035	3090	3090	1450						
									top-min	4	2	10d	6	10d	2530	2530	2530	--	2000	2000	2000	--						
	MSH422	THA422, THAI422	16	3-9/16	1-3/4	21-1/2	1-7/8	7-5/8	face-max	--	22	10d	6	10d	3340	3765	4065	1815	2935	3310	3320	1450						
									top-max	4	6	10d	6	10d	3525	3705	3830	1815	2665	2825	2935	1450						
									top-min	4	2	10d	6	10d	2530	2530	2530	--	2005	2005	2005	--						
	MSH422IF	THAC418, THAC422	16	3-5/8	1-3/4	22	--	9-13/16	face-max	--	22	10d	4	10d	2750	3085	3330	675	2420	2715	2930	540						
									top-max	4	6	10d	4	10d	3485	3575	3640	675	2520	2600	2660	540						
									top-min	4	2	10d	4	10d	2530	2530	2530	--	2000	2000	2000	--						
	MSH424	--	16	3-5/8	2	21-1/2	2-1/16	5-3/16	face-max	--	36	10d	6	10d	5090	5725	5975	1815	4150	4310	4420	1445						
									top-max	4	6	10d	6	10d	3875	3875	3875	1815	3085	3085	3085	1445						
									top-min	4	2	10d	6	10d	2530	2530	2530	--	2000	2000	2000	--						
	MSH426	THA426	14	3-5/8	1-3/4	26	1-13/16	8	face-max	--	38	16d	6	16d	5455	5675	5825	1815	4035	4230	4360	1455						
									top-max	4	8	16d	6	16d	3760	3760	3760	1795	3010	3010	3010	1435						
									top-min	4	2	16d	6	16d	2435	2435	2435	--	2160	2160	2160	--						
	MSH426IF	THAC426	14	3-5/8	1-3/4	26	--	8	face-max	--	38	16d	6	16d	5455	5675	5825	1815	4035	4230	4360	1455						
									top-max	4	8	16d	6	16d	3760	3760	3760	1795	3010	3010	3010	1435						
									top-min	4	2	16d	6	16d	2435	2435	2435	--	2160	2160	2160	--						
	(2) 3-1/2" wide Floor Trusses	MSH422-2	THA422-2	14	7-1/4	2	22-1/8	2-1/8	11	face-max	--	26	16d	6	16d	4005	4515	4845	1380	3520	3970	4260	1215					
										top-max	4	10	16d	6	16d	4665	4860	4990	1380	3480	3650	3765	1215					
										top-min	4	4	16d	6	16d	3740	3820	3870	--	2665	2735	2780	--					
MSH422-2IF		THAC422-2	14	7-1/4	2	22-1/8	--	11	face-max	--	26	16d	6	16d	4005	4515	4845	1380	3520	3970	4260	1215						
									top-max	4	10	16d	6	16d	4665	4860	4990	1380	3480	3650	3765	1215						
									top-min	4	4	16d	6	16d	3740	3820	3870	--	2665	2735	2780	--						
MSH426-2		THA426-2	14	7-1/4	2	26-1/16	2-1/8	11	face-max	--	26	16d	6	16d	4005	4515	4845	1380	3520	3970	4260	1215						
									top-max	4	10	16d	6	16d	4665	4860	4990	1380	3480	3650	3765	1215						
									top-min	4	4	16d	6	16d	3740	3820	3870	--	2665	2735	2780	--						

1) Uplift loads have been increased 60% for wind or seismic loads; no further increase shall be permitted.
 2) NAILS: 10d x 1-1/2" nails are 0.148" dia. x 1-1/2" long, 10d nails are 0.148" dia. x 3" long, 16d nails are 0.162" dia. x 3-1/2" long.

Corrosion Finish Key ■ Stainless Steel ■ Gold Coat ■ HDG ■ Triple Zinc

Continued on next page

I-Joist, LVL, LSL & PSL Chart

Joist Material & Width	MiTek Stock No.	Ref. No.	Steel Gauge	Dimensions (in)					Mounting Condition	Fastener Schedule ²				DF/SP Allowable Loads (Lbs.)				S-P-F Allowable Loads (Lbs.)				Corrosion Finish	Code Ref.	
				W	D	H	A	B		Header		Joist		Floor	Roof	Uplift ¹	Floor	Roof	Uplift ¹					
										Top Qty	Face Qty	Type	Qty							Type				
				100%	115%	125%	160%	100%		115%	125%	160%												
2x Lumber or Trusses	MSH222	THAI222	18	1-5/8	1-3/4	23	1-13/16	10-13/16	face-max	--	22	10d	4	10d x 1-1/2	2120	2190	2230	715	1540	1595	1635	575		
									top-max	4	6	10d	4	10d x 1-1/2	2120	2190	2230	715	1540	1595	1635	575		
									top-min	4	2	10d	4	10d x 1-1/2	2120	2190	2230	--	1540	1595	1635	--		
1-3/4" LVL or I-Joist	MSH1713	--	18	1-13/16	1-3/4	14-7/16	1-13/16	10-3/4	face-max	--	12	10d	4	10d	1440	1640	1770	715	1265	1445	1555	575		
									top-max	4	6	10d	4	10d	2395	2460	2505	715	1725	1785	1820	575		
									top-min	4	2	10d	4	10d x 1-1/2	2390	2390	2390	--	1725	1785	1820	--		
	MSH1722	THAI1.81/22	18	1-13/16	1-3/4	22-7/8	1-7/8	10-3/4	face-max	--	22	10d	4	10d x 1-1/2	2280	2280	2280	715	1725	1785	1820	575		
									top-max	4	6	10d	4	10d x 1-1/2	2395	2460	2505	715	1725	1785	1820	575		
								top-min	4	2	10d	4	10d x 1-1/2	2390	2390	2390	--	1725	1785	1820	--			
2" wide I-Joist	MSH2022	THAI2.06/22	18	2-1/16	1-3/4	22-5/8	1-13/16	10-7/16	face-max	--	22	10d	4	10d	2350	2350	2350	715	1875	1875	1875	570		
									top-max	4	6	10d	4	10d	2670	2735	2780	715	1910	1970	2005	570		
									top-min	4	2	10d	4	10d	2390	2390	2390	--	1890	1890	1890	--		
2-5/16" wide I-Joist	MSH2322	THAI3522	18	2-3/8	1-3/4	22-5/8	1-13/16	10-7/16	face-max	--	22	10d	4	10d x 1-1/2	2350	2350	2350	715	1875	1875	1875	570		
									top-max	4	6	10d	4	10d x 1-1/2	3010	3075	3120	715	2140	2200	2240	570		
									top-min	4	2	10d	4	10d x 1-1/2	2395	2395	2395	--	1895	1895	1895	--		
2-1/2" wide Floor Trusses	MSH322	THAI322	18	2-9/16	1-3/4	22-1/2	1-13/16	10-3/8	face-max	--	22	10d	4	10d x 1-1/2	2350	2350	2350	715	1875	1875	1875	570		
									top-max	4	6	10d	4	10d x 1-1/2	3240	3240	3240	715	2330	2385	2425	570		
									top-min	4	2	10d	4	10d x 1-1/2	2395	2395	2395	--	1895	1895	1895	--		
3-1/2" wide Floor Trusses	MSH413	THA413	16	3-9/16	1-3/4	14	1-7/8	7-5/8	face-max	--	14	10d	6	10d	2340	2640	2855	1815	2055	2325	2510	1450		
									top-max	4	6	10d	6	10d	3875	3875	3875	1815	3035	3090	3090	1450		
									top-min	4	2	10d	6	10d	2530	2530	2530	--	2000	2000	2000	--		
	MSH418	THA418	16	3-9/16	1-3/4	17-1/2	1-7/8	7-5/8	face-max	--	18	10d	6	10d	2840	3200	3460	1815	2495	2815	3040	1450		
									top-max	4	6	10d	6	10d	3875	3875	3875	1815	3035	3090	3090	1450		
									top-min	4	2	10d	6	10d	2530	2530	2530	--	2000	2000	2000	--		
	MSH422	THA422, THAI422	16	3-9/16	1-3/4	21-1/2	1-7/8	7-5/8	face-max	--	22	10d	6	10d	3340	3765	4065	1815	2935	3310	3320	1450		
									top-max	4	6	10d	6	10d	3525	3705	3830	1815	2665	2825	2935	1450		
									top-min	4	2	10d	6	10d	2530	2530	2530	--	2005	2005	2005	--		
	MSH422IF	THAC418, THAC422	16	3-9/16	1-3/4	22	--	9-13/16	face-max	--	22	10d	4	10d	2750	3085	3330	675	2420	2715	2930	540		
									top-max	4	6	10d	4	10d	3485	3575	3640	675	2520	2600	2660	540		
									top-min	4	2	10d	4	10d	2530	2530	2530	--	2000	2000	2000	--		
	MSH424	--	16	3-5/8	2	21-1/2	2-1/16	5-3/16	face-max	--	36	10d	6	10d	5090	5725	5975	1815	4150	4310	4420	1445		
									top-max	4	6	10d	6	10d	3875	3875	3875	1815	3085	3085	3085	1445		
									top-min	4	2	10d	6	10d	2530	2530	2530	--	2000	2000	2000	--		
MSH426	THA426	14	3-5/8	1-3/4	26	1-13/16	8	face-max	--	38	16d	6	16d	5455	5675	5825	1815	4035	4230	4360	1455			
								top-max	4	8	16d	6	16d	3760	3760	3760	1795	3010	3010	3010	1435			
								top-min	4	2	16d	6	16d	2435	2435	2435	--	2160	2160	2160	--			
MSH426IF	THAC426	14	3-5/8	1-3/4	26	--	8	face-max	--	16d	6	16d	5455	5675	5825	1815	4035	4230	4360	1455				
								top-max	4	8	16d	6	16d	3760	3760	3760	1795	3010	3010	3010	1435			
								top-min	4	2	16d	6	16d	2435	2435	2435	--	2160	2160	2160	--			
4-5/8" wide I-Joist	MSH2322-2	--	16	4-3/4	1-3/4	22	1-7/8	9-1/4	face-max	--	46	10d	4	10d	5560	5620	5665	675	3880	3935	3970	535		
									top-max	4	6	10d	4	10d	3485	3575	3640	675	2520	2600	2660	535		
									top-min	4	2	10d	4	10d	2530	2530	2530	--	2000	2000	2000	--		
	MSH2622-2	--	16	5-3/8	1-3/4	22	1-7/8	9-1/4	face-max	--	46	10d	4	10d	5560	5620	5665	675	3880	3935	3970	535		
									top-max	4	6	10d	4	10d	3485	3575	3640	675	2520	2600	2660	535		
									top-min	4	2	10d	4	10d	2530	2530	2530	--	2000	2000	2000	--		

Plated Truss

IBC, FL, LA

Copyright © 2022 MiTek Industries, Inc. All Rights Reserved

1) Uplift loads have been increased 60% for wind or seismic loads; no further increase shall be permitted.
 2) **NAILS:** 10d x 1-1/2 nails are 0.148" dia. x 1-1/2" long, 10d nails are 0.148" dia. x 3" long, 16d nails are 0.162" dia. x 3-1/2" long.

Corrosion Finish Key ■ Stainless Steel ■ Gold Coat ■ HDG ■ Triple Zinc

The MSHL/R is a versatile 45° skewed hanger with multiple installation options. It can be installed on a supporting girder truss as well as solid-sawn and structural composite lumber headers.

Materials: See chart

Finish: G90 galvanizing

Codes: See chart for code references

Installation:

- Install the required number of fasteners according to the load table.
- Install fasteners into the carrying members at the locations described below based on the proper "Mounting Condition."
- Web stiffeners are required for I-Joist installations.
- Hanger is factory skewed at 45° left or right.



Typical MSH213R installation

Right skew

Typical MSH213L installation

Left skew

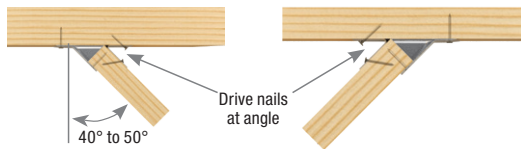

Right skew

Left skew

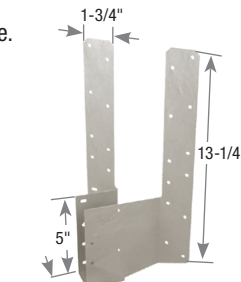

MSH213L

Left skew

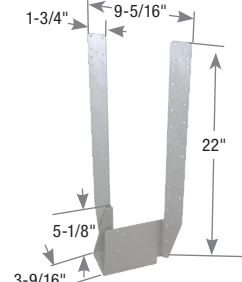

MSH422L

Left skew



MSH422R

Right skew

CONNECTION TO CARRYING MEMBER – Mounting Condition

Face-Max	Top-Max	Top-Min	Combination Face-Max/Top-Max
For MSH422L/R, the bottom six (6) fastener holes (three on each side of the bucket) must be filled. Install eight additional fasteners (four (4) in each strap) where applicable. For MSH213L/R, the bottom eight (8) fastener holes must be filled (four (4) in each strap). Install fourteen (14) additional fasteners, seven (7) in each strap. Min. 2x6 bottom chord required.	The straps must be field-bent over the header a minimum of 2" to allow four (4) top flange nail holes to be filled (two in each strap). The bottom six (6) fastener holes (three on each side of the bucket) must be filled. Min. 2x6 bottom chord required.	The straps must be field bent over the header a minimum of 2" to allow four (4) top flange nail holes to be filled (two in each strap). Also install the two (2) uppermost face nails (one on each strap) near the top of the header.	Follow the Face-Max installation for one side of the connector and the Top-Max installation for the opposite side of the connector. The Face-Max allowable loads apply to this type of installation. Min. 2x6 bottom chord required.
Typical MSHL/R face-max installation	Typical MSHL/R top-max installation	Typical MSHL/R top-min installation	Typical MSHL/R combination installation

CONNECTION TO CARRIED MEMBER – All Mounting Conditions

Install six (6) 10d x 1-1/2" nails into 2x carried member, or six (6) 10d nails into 3-1/2" wide carried member.

Joist Material & Width	MiTek Stock No.	Ref. No.	GA	Mounting Condition	Fastener Schedule ²				DF/SP Allowable Loads (Lbs.)				S-P-F Allowable Loads (Lbs.)				Code Ref.	
					Header		Joist		Download				Uplift ¹					
					Top Qty	Face Qty	Type	Qty	Type	100%	115%	125%	160%	100%	115%	125%		160%
									Type	100%	115%	125%	160%	100%	115%	125%		160%
2x Lumber or Trusses	MSH213L/R	--	18	face-max	--	22	10d	6	10d x 1-1/2	1770	1770	1770	670	1430	1430	1430	540	IBC, FL, LA 1) Uplift loads have been increased 60% for wind or seismic loads; no further increase shall be permitted. 2) NAILS: 10d x 1-1/2 nails are 0.148" dia. x 1-1/2" long, 10d nails are 0.148" dia. x 3" long New products or updated product information are designated in blue font .
				top-max	4	6	10d	6	10d x 1-1/2	1810	1810	1810	670	1460	1460	1460	540	
				top-min	4	2	10d	6	10d x 1-1/2	1325	1325	1325	--	1240	1240	1240	--	
				combination	2	14	10d	6	10d x 1-1/2	1770	1770	1770	670	1430	1430	1430	540	
3-1/2" LVL or Floor Trusses	MSH422L/R	THAL/R422	16	face-max	--	14	10d	6	10d	1750	1755	1755	560	1395	1395	1395	445	
				top-max	4	6	10d	6	10d	1820	1820	1820	560	1490	1490	1490	445	
				top-min	4	2	10d	6	10d	1385	1385	1385	--	1100	1100	1100	--	
				combination	2	10	10d	6	10d	1750	1755	1755	560	1395	1395	1395	445	

Copyright © 2022 MiTek Industries, Inc. All Rights Reserved

MiTek's MSSH217 hanger accommodates a skew range of 60° to 85° (30° maximum off the girder) without the need for a more expensive custom design hanger. Face nail to webs or bend the flange strap over the chord. Available in left (L) or right (R) configurations.

Materials: 18 gauge
Finish: G90 galvanizing

Installation:

- Use all specified fasteners. See Product Notes, page 18.
- The 3 lower holes on each strap are for top nailing when the strap is bent over the truss chord. These holes are not for face nailing.
- One or both straps may be bent over the bottom chord of the girder with top or backside nailing.
- **Note:** Select the correct (right or left) hanger so that the strap on the outside of the angle will pass the end of the truss. When facing the hanger, the strap in the rear turns in the direction of the skew. The front strap turns to pass behind the end of the carried member.
- Attach the hanger at the end of the truss with a single 10d (0.148" dia.) x 1-1/2" nail into the side flange or bottom.
- Place the truss in position against the girder. Push the outside strap past the end of the truss to the girder web and face nail through the top 8 holes with 10d (0.148" dia.) x 1-1/2" nails for a 1-ply girder, or 10d (0.148" dia. x 3") common nails for multiple-ply girders.
- The strap inside the angle can be formed over diagonal webs (if design allows) or bend over the girder chord. Use two nails into the top and/or back side of the girder.
- If the outside strap does not contact a web, bend the strap tightly over the girder chord. Use two nails into the top and/or back side of the girder.
- For uplift resistance, other means of attachment are required. If both the truss and girder have vertical webs, attach a scab to pack out the girder web nearly flush with the truss web and use a field adjustable MP framing angle across the two. A top chord connection for uplift requires a flat LSTA strap tie wrapped under the girder and over the truss chord.



MSSH217L
 Left shown attached to web and top of chord

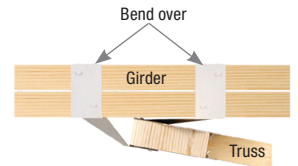

Top view right shown



MSSH217R
 Right shown attached to webs

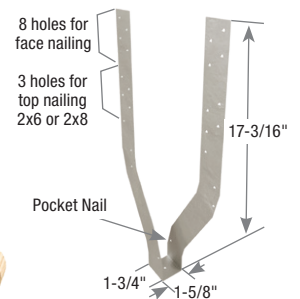

MSSH217R
 Right shown

Plated Truss

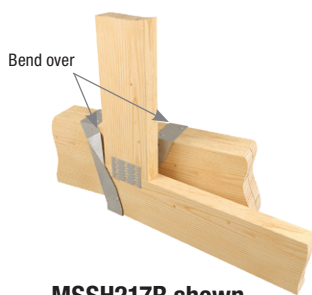

MSSH217R shown bent over bottom chord

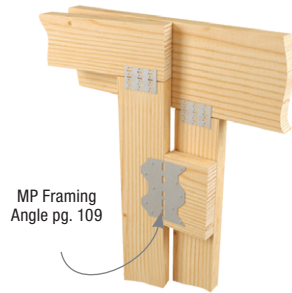

Additional strapping for high uplift



Additional strapping for high uplift

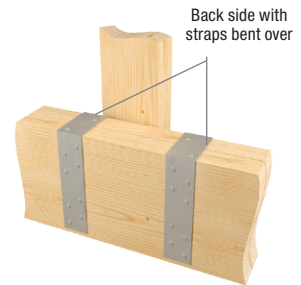

Back view shown

MiTek Stock No.	Ref. No.	Steel Gauge	Mounting Condition	Fastener Schedule ^{2,3,5}						Girder Truss	DF/SP Allowable Loads (Lbs.) ¹			S-P-F Allowable Loads (Lbs.) ¹			Code Ref.
				Supporting Member		Supported Member ⁴		100%	115%		125%	100%	115%	125%			
				Top	Face/Backside	Qty	Type								Floor	Roof	
				Qty	Type	Qty	Type	Qty	Type								
MSSH217L/R	--	18	face-max	--	--	16	10d	1	10d x 1-1/2	1 Ply	1755	1770	1770	1140	1155	1165	--
			top-min	4	10d	6	10d			1 Ply	1735	1735	1735	1140	1155	1165	

1) No uplift value with this hanger. Use other hardware or nailing higher on supported member to counteract uplift.
 2) One or both straps may be bent over bottom chord of girder with top or backside nailing.
 3) Maintain minimum 3/4" edge distance when installing nails.
 4) The supported member shall be supported by blocking or other means to prevent rotation.
 5) **NAILS:** 10d x 1-1/2 nails are 0.148" dia. x 1-1/2" long, 10d nails are 0.148" dia. x 3" long.

Note: The 3 lower holes on each strap are for top nailing when strap is bent. These holes are not for face nailing.

MiTek's MSHA Series hanger offers the most flexible field solution for truss-to-truss connections accommodating a range of skews and challenging web-chord geometry often found in truss framing. Eliminating the need for special orders, the MSHA Series hanger provides economical solutions for 1-ply or 2-ply roof trusses and 1-ply floor trusses skewed between 22-1/2° to 75°. MSHA hangers can be installed in top-min, top-max, face-max, or combination mounting conditions as required.

Materials: 16 gauge

Finish: G90 galvanizing

Installation:

- Install the required number of fasteners according to the load table.
- Install fasteners into the carrying member at the locations described below based on the proper "Mounting Condition".
- Product is factory skewed 22-1/2° and may be field skewed from 22-1/2° to 75°. See installation sequence on page 279 for skews greater than 22-1/2°.
- Face-Max and Combination mounting conditions require a minimum chord or header height of 7-1/4". Top-Max and Top-Min mounting conditions require a minimum chord or header height of 5-1/2".

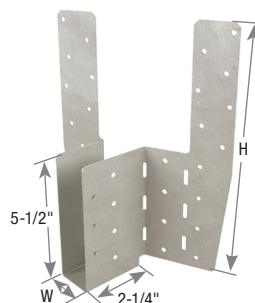

MSHA29L
Left Shown



MSHA29R-2
Right Shown

CONNECTION TO CARRYING MEMBER
Mounting Conditions:

Face-Max

Fill the lowest four holes nearest each side of the bucket. For a 22-1/2° skew, fill the four diamond holes on one side and 4 round holes on the other. For skews greater than 22-1/2°, fill the 4 round holes on each side.

Add an equal amount of nails in each side of the hanger in any of the remaining nail holes to meet the minimum fastener requirements listed in the table on page 279.



Typical MSHA
face-max installation

Top-Max

Field bend the strap over the supporting member. The bent strap must extend a minimum of 2" over the carrying member to allow for the four top flange nail holes to be filled.

Fill the lowest four nail holes nearest each side of the bucket. For a 22-1/2° skew, fill the four diamond holes on one side and 4 round holes on the other. For skews greater than 22-1/2°, fill the 4 round holes on each side.

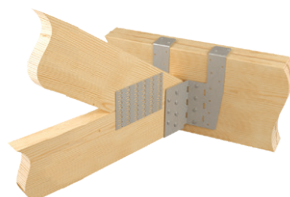

Typical MSHA
top-max installation

Top-Min

Field bend the strap over the supporting member. The bent strap must extend a minimum of 2" over the carrying member to allow for the four top flange nail holes to be filled.

Fill the four nail holes (two each strap) nearest the top of the carrying member.



Typical MSHA
top-min installation

Combination
Face-Max/Top-Max

Follow the Face-Max installation for one side of the connector. Follow the Top-Max installation for the opposite side of the connector. The Face-Max allowable loads apply to this type of installation.



Typical MSHA
combination installation

CONNECTION TO CARRIED MEMBER
Mounting Conditions:

For the 22-1/2° skew installation, all round holes must be filled. For skews greater than 22-1/2°, all holes must be filled in bucket including diamond holes.

Installation Sequence for Skews > 22½°:

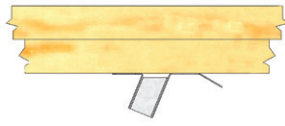

Step 1: Install acute side top and/or face header nails.

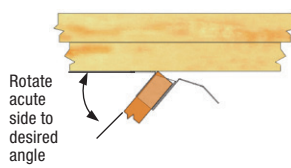

Step 2: Utilizing a piece of scrap fastened to the hanger on the obtuse side, bend the hanger to the desired angle.

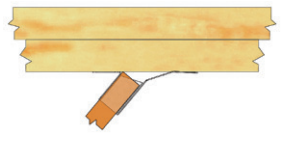

Step 3: Bend the obtuse side of hanger back toward the header until the flange lies flat against the header, and install header top and/or face nails as noted below.

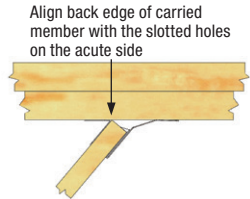

Step 4: Install carried truss and all required nails fasteners working from the bottom up.

Joist Material & Width	MiTek Stock No.	Ref. No.	Dimensions (in)		Min H _{eff} ² (in)	Mounting Condition ³	Skew Angle (degrees)	Fastener Schedule ⁴					DF/SP Allowable Loads (Lbs.)				S-P-F Allowable Loads (Lbs.)				Code Ref.
			Carrying Member					Carried Member			Allowable Loads (Lbs.)				Allowable Loads (Lbs.)						
			Top Qty	Face Qty				Type	Qty	Type	100%	115%	125%	160%	Uplift ¹	100%	115%	125%	160%		
2x Trusses	MSHA29L/R	THASR/L29	1-5/8	10-3/4	7-1/4	face-max	22-1/2	--	12	10d	7	10d x 1-1/2	1500	1615	1615	975	1250	1275	1275	770	--
							23 to 45	--	12	10d	4	10d x 1-1/2	1485	1485	1485	560	1250	1350	1350	435	
							46 to 75	--	12	10d	4	10d x 1-1/2	1500	1615	1615	720	1250	1315	1315	560	
			5-1/2	top-max	22-1/2	4	8	10d	7	10d x 1-1/2	1985	1985	1985	975	1510	1510	1510	745			
					23 to 45	4	8	10d	4	10d x 1-1/2	1705	1705	1705	560	1255	1255	1255	415			
					46 to 75	4	8	10d	4	10d x 1-1/2	1605	1605	1605	720	1605	1605	1605	560			
				top-min	22-1/2	4	4	10d	7	10d x 1-1/2	1350	1350	1350	--	1045	1045	1045	--			
					23 to 45	4	4	10d	4	10d x 1-1/2	1335	1335	1335	--	1060	1060	1060	--			
					46 to 75	4	4	10d	4	10d x 1-1/2	695	695	695	--	695	695	695	--			
2-2x Trusses	MSHA29L/R-2	THASR/L29-2	3-1/8	10-3/4	7-1/4	face-max	22-1/2	--	12	10d	7	10d	1500	1615	1615	975	1215	1215	1215	735	
							23 to 45	--	12	10d	4	10d	1485	1485	1485	560	1210	1260	1260	405	
							46 to 75	--	12	10d	4	10d	1500	1615	1615	720	1250	1300	1300	555	
			5-1/2	top-max	22-1/2	4	8	10d	7	10d	1985	1985	1985	975	1495	1495	1495	735			
					23 to 45	4	8	10d	4	10d	1705	1705	1705	560	1275	1275	1275	420			
					46 to 75	4	8	10d	4	10d	1605	1605	1605	720	1565	1565	1565	535			
				top-min	22-1/2	4	4	10d	7	10d	1350	1350	1350	--	1040	1040	1040	--			
					23 to 45	4	4	10d	4	10d	1335	1335	1335	--	1060	1060	1060	--			
					46 to 75	4	4	10d	4	10d	695	695	695	--	695	695	695	--			
4x Trusses	MSHA422L/R	THASR/L422	3-5/8	22	7-1/4	face-max	22-1/2	--	12	10d	7	10d	1500	1590	1590	960	1250	1250	1250	755	
							23 to 45	--	12	10d	4	10d	1485	1485	1485	550	1250	1335	1335	430	
							46 to 75	--	12	10d	4	10d	1500	1615	1615	705	1250	1300	1300	555	
			5-1/2	top-max	22-1/2	4	8	10d	7	10d	1955	1955	1955	960	1490	1490	1490	735			
					23 to 45	4	8	10d	4	10d	1680	1680	1680	550	1270	1270	1270	420			
					46 to 75	4	8	10d	4	10d	1605	1605	1605	705	1565	1565	1565	535			
				top-min	22-1/2	4	4	10d	7	10d	1330	1330	1330	--	1040	1040	1040	--			
					23 to 45	4	4	10d	4	10d	1335	1335	1335	--	1060	1060	1060	--			
					46 to 75	4	4	10d	4	10d	695	695	695	--	695	695	695	--			

1) Uplift loads have been increased 60% for wind or seismic loads; no further increase shall be permitted.
 2) H_{eff} is the minimum distance from the top of the hanger seat to the top of the carrying member.
 3) For tabulated top-mount installation loads, the straps must be wrapped over the header a minimum of 2".
 4) **NAILS:** 10d x 1-1/2 nails are 0.148" dia. x 1-1/2" long, 10d nails are 0.148" dia. x 3" long.

The SNP3 Skewed Nail Plate is designed for connecting square cut corner jack trusses at skews from 0° to 90°, as depicted in **Figure 1 below**. An alternate installation for front side attachment at skews 0° to 45° is depicted in Figure 2 below.

Materials: 16 gauge
Finish: G90 galvanizing
Codes: See chart for code references

Installation:

- **Bend angle only once.**
- 8d common (0.131" dia. x 2-1/2" long) nails may be used in lieu of 8d (0.131") x 1-1/2" nails with no reduction in load.

Typical Installation (Figure 1):

- Attach the SNP3 to the supported truss on the acute angle side so the SNP3 runs behind the end of the jack truss. Use all the specified fasteners listed in the table below. The fasteners should be installed nearest to bend line as possible then working to the opposite end of flange. Not all nail holes will be filled.
- Set the jack truss against the supporting truss and nail the exposed flange of the SNP3 into place. Use all the specified fasteners listed in the table below. The fasteners should be installed nearest to bend line as possible then working to the opposite end of flange. Not all nail holes will be filled.

Alternate Installation (Figure 2):

- Attach the SNP3 to the supported truss on the obtuse angle side so the SNP3 is on the front side of the jack truss. Use all the specified fasteners listed in the table below. The fasteners should be installed nearest to bend line as possible then working to the opposite end of flange but no closer than 5/8" from the end of the truss. Not all nail holes will be filled.
- Set the jack truss against the supporting truss and nail the exposed flange of the SNP3 into place. Use all the specified fasteners listed in the table below. The fasteners should be installed nearest to bend line as possible then working to the opposite end of flange. Not all nail holes will be filled.

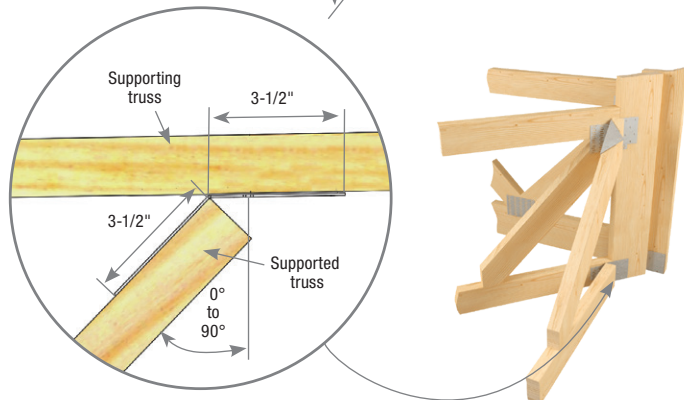
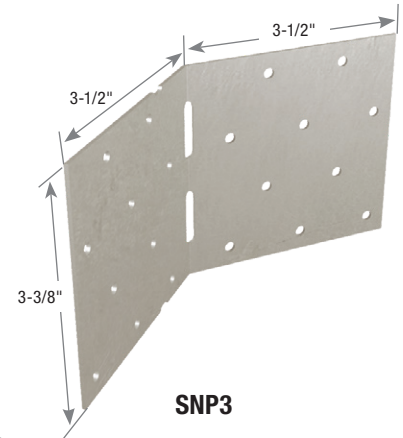

Typical SNP3 installation
Figure 1

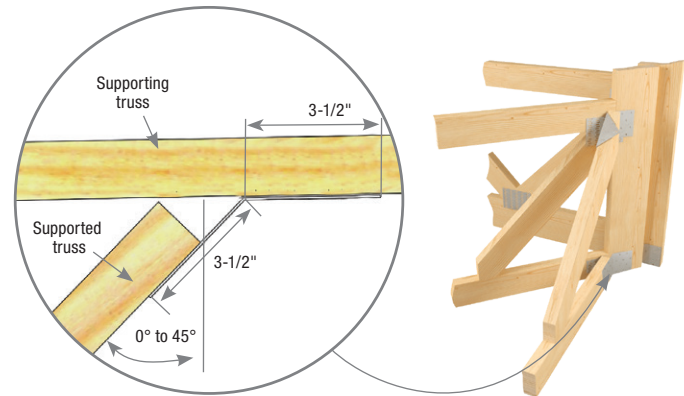

Alternate SNP3 installation
Figure 2

MiTek Stock No.	Ref. No.	Steel Gauge	Installation Type ⁴	Fastener Schedule ²				DF/SP Allowable Loads (Lbs.) ¹		S-P-F Allowable Loads (Lbs.) ¹		Code Ref.
				Supporting Member		Supported Member		Download (100/115/125)	Upift 160%	Download (100/115/125)	Upift 160%	
				Qty	Type	Qty	Type					
SNP3	TJC37	16	Figure 1	6	8d x 1-1/2	6	8d x 1-1/2	475	475	415	415	IBC, FL, LA
			Figure 2	6	8d x 1-1/2	6	8d x 1-1/2	335	335	295	295	--

1) Allowable loads have been increased 60% for wind or seismic loads; no further increase shall be permitted.
 2) Install specified fasteners from the bend line out from each end. Not all nail holes will be filled.
 3) When installing SNP3's back to back, the table loads shall be multiplied by a reduction factor of 0.78.
 4) Refer to images for installation type.
 5) **NAILS:** 8d x 1-1/2 nails are 0.131" dia. x 1-1/2" long.

HHC – Designed to support hip/hip truss/rafter. Contact MiTek when using in multi-ply applications

HJHC – Allows for hip/hip support and hip/jack/hip installations

HJC / HTHJ – Used to simultaneously hang a combination of hips and jacks off girder trusses. These hangers fit both left-hand and right-hand applications. An open back design allows for retrofit installations

Materials: HHC/HJC/HJHC – 12 gauge, HTHJ –18 gauge

Finish: G90 galvanizing

Options: See HJC Specialty Options Chart below

Codes: See chart for code references

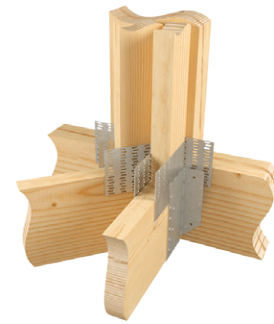

Typical HJC/HTHJ installation



Typical HJC/HTHJ installation top view

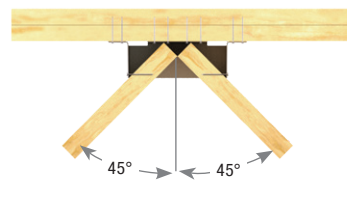

Typical HHC installation top view

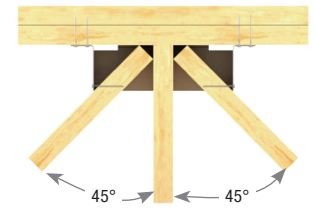

Typical HJHC installation top view

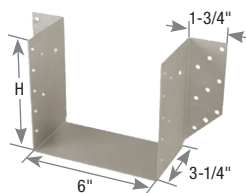

HJC

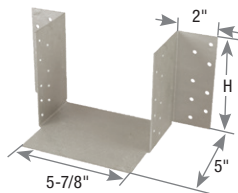

HTHJ

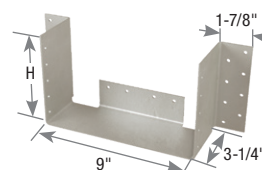

HHC

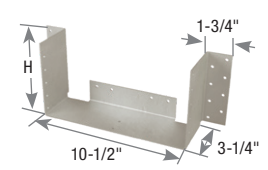

HJHC

Description	MiTek Stock No.	Ref. No.	Steel Gauge	H (in)	Fastener Schedule ³					DF/SP Allowable Loads (Lbs.) ²				S-P-F Allowable Loads (Lbs.) ²				Code Ref.
					Supporting Member		Supported Member			Floor	Roof	Uplift ¹	Floor	Roof	Uplift ¹			
					Qty	Type	per Hip	per Jack	Type							100%	115%	
2 x 6 right / left	HJC26	LTHJA26, THJA26, THJU26	12	5-3/8	16	16d	5	7	10d	2750	3055	3265	2345	2420	2685	2750	1905	IBC, FL, LA
2 x 8 right / left	HJC28	--	12	7-1/8	20	16d	6	8	10d	3385	3385	3385	2345	2760	2760	2760	1910	
2 x 6 terminal	HHC26	LTHJA26, THJA26	12	5-7/16	20	16d	5	--	10d	3100	3505	3505	2130	2725	2800	2800	1870	--
2 x 8 terminal	HHC28	--	12	7-3/16	24	16d	6	--	10d	3505	3505	3505	2410	2805	2805	2805	1930	
2 x 6 terminal	HJHC26	--	12	5-7/16	20	16d	5	2	10d	3100	3505	3505	2410	2725	2815	2815	1935	
2 x 8 terminal	HJHC28	--	12	7-3/16	24	16d	6	2	10d	3505	3505	3505	2410	2820	2820	2820	1940	
2 x 6 terminal	HTHJ26-18	--	18	5	16	16d	7	5	16d	2295	2605	2695	1790	1985	2110	2110	1225	

1) Uplift loads have been increased 60% for wind or seismic loads; no further increase shall be permitted.

2) Table values are the total load of hip/jack combined, and assume that the allowable download and uplift of a single member are no more than 75% of the total hanger capacity.

3) **NAILS:** 10d nails are 0.148" dia. x 3" long, 16d nails are 0.162" dia. x 3-1/2" long.

HJC Specialty Options Chart – Refer to Specialty Options pages 320-321 for additional details.

Option	Hip Truss Skew
Range	30° to 60°
Allowable Loads	100% of table load
Ordering	Add SK, angle of hip required, to product number. Ex. HJC26_SK55

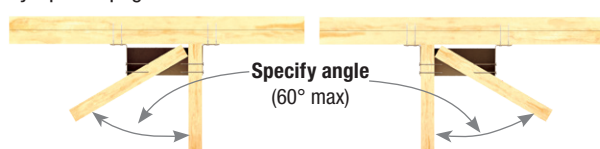

Typical HJC (skewed) installation with alternate skew angle top view

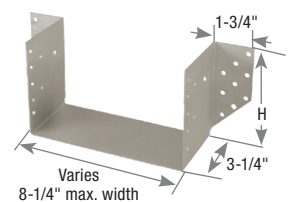

HJC (skewed)

BN Breakfast Nook Hangers

Plated Truss

Designed to carry four mono trusses in one connector, it reduces installation time and cost. Provides a tested, load rated connection. Standard configuration spacing: 22-1/2°, 45°, 45°, 45°, 22-1/2°. The design also includes field adjustable nailing tabs.

Materials: 14 gauge

Finish: Primer

Codes: IBC, FL, LA

Installation:

- Use all specified fasteners. See Product Notes, page 18.
- Allow a 2" setback for each mono truss.
- For pitched ceiling, design mono trusses with end-vertical upset. Upset equals tangent of the ceiling slope times 5.6".
- Bend tab only once.

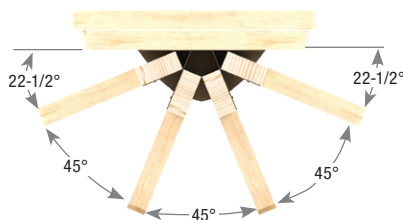

BN264
Standard configuration
(top view)

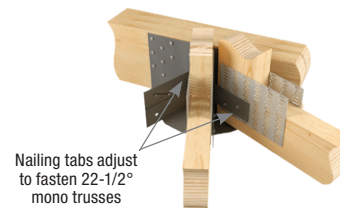

Typical BN264
installation

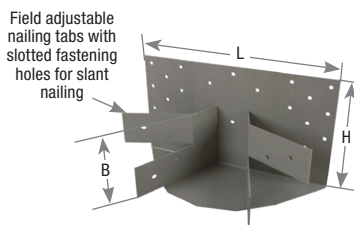

BN264

MiTek Stock No.	Ref. No.	Steel Gauge	Dimensions (in)			Fastener Schedule ⁴				DF/SP Allowable Loads (Lbs.) ³				S-P-F Allowable Loads (Lbs.) ³			Code Ref.	
			L	H	B	Carrying Member		Carried Member per Mono Truss		Floor	Roof	Uplift ^{1,2}	Floor	Roof	Uplift ^{1,2}			
						Qty	Type	Qty	Type									
BN264	THJM2-4-SDS3	14	10	5-3/8	3-1/4	20	10d	2	10d x 1-1/2	2640	3035	3145	585	2325	2635	2635	475	IBC,
BN284	--	14	10	7-1/8	3-1/4	20	10d	2	10d x 1-1/2	2640	3035	3145	585	2325	2635	2635	475	FL, LA

- 1) Uplift loads have been increased 60% for wind or seismic loads; no further increase shall be permitted.
- 2) Maximum uplift per mono truss is 175-lb at 160% for DF/SP and 150-lb at 160% for S-P-F.
- 3) Loading published is for total load of connection.
- 4) **NAILS:** 10d x 1-1/2 nails are 0.148" dia. x 1-1/2" long, 10d nails are 0.148" dia. x 3" long.

LDSC / DSC Drag Strut Connectors

Transfers lateral loads from girder truss into bearing walls.

Materials: See chart

Finish: Primer

Codes: IBC, FL, LA

Installation:

- Use all specified fasteners. See Product Notes, page 18.
- MiTek's WS3 structural wood screws, 1/4" dia. x 3" long, are supplied with DSC4 connector.

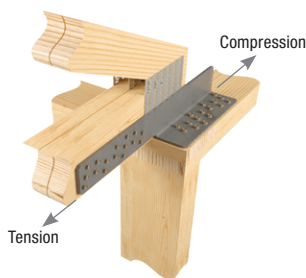

Typical DSC4R installation

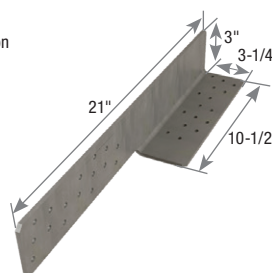

DSC4R right shown

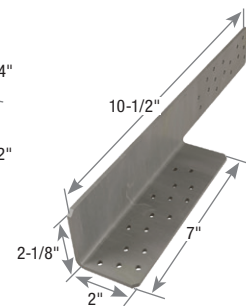

LDSC4L left shown

MiTek Stock No.	Ref. No.	Steel Gauge	Fastener Schedule ^{2,3}				DF/SP Allowable Loads (Lbs.) ¹		S-P-F Allowable Loads (Lbs.) ¹		Code Ref.
			Truss		Top Plate		Compression	Tension	Compression	Tension	
			Qty	Type	Qty	Type					
LDSC4L/R	--	14	9	10d x 1-1/2	9	10d x 1-1/2	1500	1505	1020	1025	IBC,
DSC4L/R	DSC5R/L-SDS3	3	16	WS3	16	WS3	4965	4655	3380	3170	FL, LA

- 1) Allowable loads have been increased 60% for wind or seismic loads; no further increase shall be permitted.
- 2) MiTek's WS3 structural wood screws are 1/4" dia. x 3" long and are included with DSC4 connector.
- 3) **NAILS:** 10d x 1-1/2 nails are 0.148" dia. x 1-1/2" long.

Copyright © 2022 MiTek Industries, Inc. All Rights Reserved

The GTWS series girder-to-girder hangers feature high uplift capacities along with high gravity load ratings.

Materials: 10 gauge

Finish: G90 galvanizing

Codes: FL

Installation:

- Use all specified fasteners. See Product Notes, page 18.
- MiTek's WS structural wood screws are included with hangers where specified.
- **GTWS2T** shall be installed to a minimum 2x4 vertical member of a girder truss with no restriction on the size of the bottom chord.
- **GTWS3T** shall be installed to a minimum 2x6 vertical member of a girder truss with no restriction on the size of the bottom chord.
- **GTWS4T** shall be installed to a minimum 2x8 vertical member of a girder truss with no restriction on the size of the bottom chord.

Supported truss end vertical min 2x6 required. Ensure truss plate is installed flush bottom and min 3" in height (to resist end grain splitting)

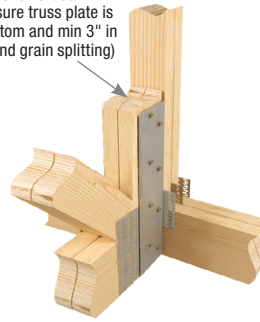

Typical GTWS installation

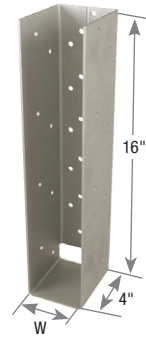

GTWS2T

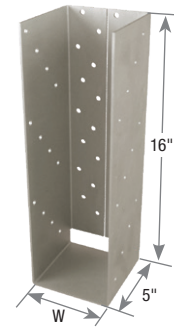

GTWS3T

Plated Truss

MiTek Stock No.	Ref. No.	Steel Gauge	Dimensions (in)			Fastener Schedule ^{2,3,4}				No. of Plies	DF/SP Allowable Loads (Lbs.)				Code Ref.
						Supporting Truss		Supported Truss			Uplift ¹				
			W	H	D	Qty	Type	Qty	Type		100%	115%	125%	160%	
GTWS2T	--	10	3-1/4	16	4	22	WS3	16	WS3	2	8720	10030	10900	9770	FL
GTWS3T	--	10	4-7/8	16	5	28	WS3	24	WS3	3	11100	12470	12470	12490	
GTWS4T	--	10	6-1/2	16	5	28	WS3	24	WS3	4	11100	12470	12470	12490	

- 1) Uplift loads have been increased 60% for wind or seismic loads; no further increase shall be permitted.
- 2) MiTek's WS3 structural wood screws require a minimum 3" wood penetration.
- 3) MiTek's WS3 (1/4" dia. x 3" long) structural wood screws are included with the GTWS hangers.
- 4) MiTek's WS3 structural wood screws may be installed in both vertical and horizontal members.

The GT primarily hangs girder trusses off other girder trusses, although a wide variety of other heavy-duty installations apply.

Materials: Back Plate – 3 gauge; Strap – 7 gauge

Finish: Primer

Options: All models available in LVL sizes, use M in place of T, as in GT2M4B

Codes: See chart for code references

Installation:

- Use all specified fasteners. See Product Notes, page 18.
- Minimum heel height is 9-1/4" for GT hangers.



Typical GT2T4B installation

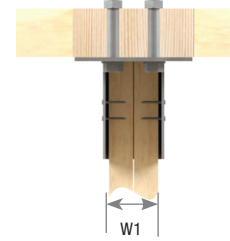

GT top view

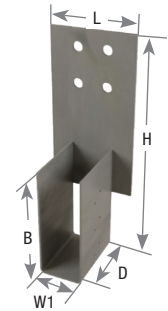

GT2T4B

Supported Member	MiTek Stock No.	Ref. No.	Dimensions (in)					Fastener Schedule ³				No. of Supporting Plies	DF/SP Allowable Loads (Lbs.)			S-P-F Allowable Loads (Lbs.)			Code Ref.
			W1	L	H	D	B	Supporting Truss ²		Supported Truss			Supporting Member			Supporting Member			
								Qty	Dia. (in) ¹	Qty	Type		100%	115%	Uplift 160%	100%	115%	Uplift 160%	
			2-ply	GT2T2B	--	3-7/16	6	19	4-1/2	9-1/4	2		3/4	12	16d	2	2950	3390	
GT2T2BH	--	3-7/16		6	22-1/4	4-1/2	9-1/4	2	1	12	16d	≥ 3	3340	3840	3085	3475			
GT2T3B	--	3-7/16		6	22	4-1/2	9-1/4	3	3/4	12	16d	2	4370	5025	2705	3710	4265	2270	
GT2T4B	THGB2	3-7/16		7	19	5-1/2	9-1/4	4	3/4	12	16d	2	5905	6790		5040	5795		
GT2T6B	--	3-7/16		7-1/4	22	6	9-1/4	6	3/4	12	16d	2	8860	10190	2705	7560	8695	2270	
GT2T6BH	--	3-7/16		7-1/4	26-1/4	6	9-1/4	6	1	12	16d	2	11795	13565		9640	9940		
GT2T8B	THGBH2	3-7/16		7-1/4	25	6	9-1/4	8	3/4	12	16d	2	11815	13585	2705	9640	9940	2270	
GT3T3B	--	5-1/8	6	22	4-1/2	9-1/4	3	3/4	12	16d	2	4370	5025	3710		4265			
3-ply	GT3T3BH	--	5-1/8	6	26-1/4	4-1/2	9-1/4	3	1	12	16d	2	5740	6605	2705	4830	5555	2270	
	GT3T4B	THGB3	5-1/8	7	19	5-1/2	9-1/4	4	3/4	12	16d	2	5905	6790		5040	5795		
	GT3T4BH	--	5-1/8	7	22-1/4	5-1/2	9-1/4	4	1	12	16d	2	7865	9045	2705	6685	7690	2270	
	GT3T6B	--	5-1/8	7-1/4	22	6	9-1/4	6	3/4	12	16d	2	8860	10190		7560	8695		
	GT3T6BH	--	5-1/8	7-1/4	26-1/4	6	9-1/4	6	1	12	16d	2	11795	13565	2705	10030	11535	2270	
	GT3T8B	THGBH3	5-1/8	7-1/4	25	6	9-1/4	8	3/4	12	16d	2	11815	13585		10080	11590		
	GT3T8BH	--	5-1/8	7-1/4	30-1/4	6	9-1/4	8	1	12	16d	2	15725	18085	2705	13370	13765	2270	
	GT3T8BH	--	5-1/8	7-1/4	30-1/4	6	9-1/4	8	1	12	16d	≥ 3	19205	19465		13465	13765		

IBC, FL, LA

1) Bolts shall conform to ASTM A 307 Grade A or better.

2) GT series require 2 x 6 vertical member for 2, 3, and 4-bolt hangers and 2 x 8 for 6 and 8-bolt hangers. Center the hanger on the vertical supporting member.

3) **NAILS:** 16d nails are 0.162" dia. x 3-1/2" long.

Continued on next page

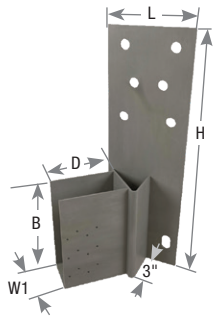

GT skewed

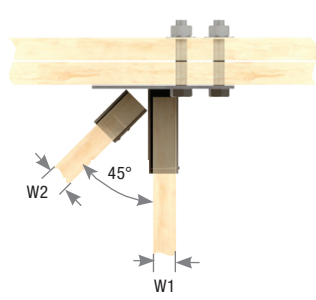

GTS
top view (left shown)

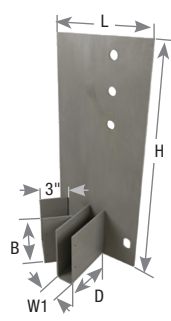

GTS1T2H3BSKL
(left shown)

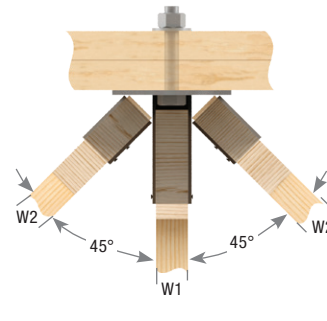

GTD
top view

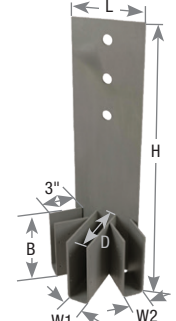

GTD1T1H3B

Supported Member	MiTek Stock No. ⁵	Ref. No.	Dimensions (in)						Fastener Schedule ⁶						No. of Supporting Plies	DF/SP Allowable Loads (Lbs.) ¹			S-P-F Allowable Loads (Lbs.) ¹			Code Ref.
			W1	W2 ⁴	L	H	D	B	Supporting Truss ³		Supported Truss		Supported Hip			Supporting Member			Supporting Member			
									Qty	Bolt Dia. ²	Qty	Type	Qty	Type		100%	115%	Uplift 160%	100%	115%	Uplift 160%	
																	2	100%	115%	Uplift 160%	100%	
4-ply	GT4T4B	--	6-1/2	--	7-1/2	19	5-1/2	9-1/4	4	3/4	12	16d	--	--	2	5905	6790	2705	5040	5795	2270	IBC, FL, LA
														≥ 3	6680	7680			6175	7100		
	GT4T4BH	--	6-1/2	--	7-1/2	22-1/4	5-1/2	9-1/4	4	1	12	16d	--	--	2	7860	9040	2705	6685	7685	2270	
														≥ 3	11440	11555			9720	10100		
	GT4T6B	--	6-1/2	--	7-1/2	22	6	9-1/4	6	3/4	12	16d	--	--	2	8860	10185	2705	7560	8690	2270	
													≥ 3	10020	11525		9260		10650			
GT4T6BH	--	6-1/2	--	7-1/2	26-1/4	6	9-1/4	6	1	12	16d	--	--	2	11790	13560	2705	10025	11530	2270		
													≥ 3	14860	14860			13075	13075			
GT4T8B	THGBH4	6-1/2	--	7-1/2	25	6	9-1/4	8	3/4	12	16d	--	--	2	11810	13580	2705	10080	11590	2270		
													≥ 3	13360	15365			12345	13090			
5-ply	GT5T8BH	--	8-1/8	--	9-1/4	30-1/4	6	9-1/4	8	1	12	16d	--	--	2	15690	18045	2705	13340	15345	2270	
															≥ 3	19465	19465			16350		16350
2-ply skewed 45°	GT2T2BSKL/R	--	3-7/16	--	6	19	4-1/2	9-1/4	3	3/4	12	16d	--	--	2	2920	3355	2000	2555	2715	1600	
														≥ 3	3295	3785			3075	3075		
GT2T4BSKL/R	--	3-7/16	--	7-1/4	19	4-1/2	9-1/4	5	3/4	12	16d	--	--	2	5835	6710	2000	5110	5875	1600		
													≥ 3	6585	7575			6220	6675			
1-ply hip & jack	GTS1T1H3BSKL/R	--	1-5/8	1-5/8	9-1/4	22	4-1/2	5-1/2	4	3/4	4	10d x 1-1/2	4	10d x 1-1/2	2	4215	4850	--	3690	4005	--	
														≥ 3	4755	5470			4495	4570		
GTS1T1H4BSKL/R	--	1-5/8	1-5/8	9-1/4	19	4-1/2	5-1/2	5	3/4	4	10d x 1-1/2	4	10d x 1-1/2	2	5830	6705	--	5105	5760	--		
													≥ 3	6580	7565			5590	5760			
2-ply hip & 1-ply jack	GTS1T2H3BSKL/R	--	1-5/8	3-7/16	9-1/4	22	5-1/2	5-1/2	4	3/4	4	10d x 1-1/2	4	10d x 1-1/2	2	4215	4850	--	3690	3985	--	
													≥ 3	4755	5470		4495		4545			
1-ply terminal hip	GTD1T1H2B	--	1-5/8	1-5/8	6	19	4-1/2	5-1/2	2	3/4	4	10d x 1-1/2	4	10d x 1-1/2	2	2920	3360	--	2555	2940	--	
													≥ 3	3295	3790		3115		3295			
1-ply terminal hip	GTD1T1H3B	--	1-5/8	1-5/8	6	22	4-1/2	5-1/2	3	3/4	4	10d x 1-1/2	4	10d x 1-1/2	2	4240	4875	--	3710	3990	--	
													≥ 3	4785	5500		4520		4550			
2-ply terminal hip	GTD1T2H3B	--	1-5/8	3-7/16	8	22	5-1/2	5-1/2	3	3/4	4	10d x 1-1/2	4	10d x 1-1/2	2	4225	4855	--	3695	3975	--	
															≥ 3	4765	5480			4500		4535

1) Allowable loads for GTS and GTD is the total of hip and jack connection.
 2) Bolts shall conform to ASTM A 307 or better.
 3) GT Series require 2 x 6 vertical member for 2, 3, and 4 bolt hangers and 2 x 8 for 6 and 8 bolt hangers.
 4) All side pocket applications assume 45° angle.
 5) Must specify right or left for all GTS and GT skewed.
 6) NAILS: 10d x 1-1/2 nails are .0148" dia. x 1-1/2" long, 16d nails are .0162" dia. x 3-1/2" long.

Copyright © 2022 MiTek Industries, Inc. All Rights Reserved

Plated Truss

The GTQ / GTQM hangers connect to multi-ply girder truss with MiTek's WS structural wood screws offering high load capacities. Design features minimum and maximum fastening installation options to accommodate various sizes of vertical web. GTQM's are designed for LVL sizes, for example GTQM218.

Materials: 7 gauge

Finish: G90 galvanizing

Installation:

- Install all MiTek's WS structural wood screws as specified.
- Install hanger centered on vertical web.
- GTQ's are designed to be installed on various sizes of vertical web. Maintain a minimum 5/8" fastener edge distance as per the National Design Specification where truss connector plates are not present.
- Install MiTek's WS structural wood screws in all fastener holes including diamond holes for maximum values.
- Refer to Backer Block installation on page 287 if the length of the screws going into the supporting truss are longer than the thickness of the plies.



Typical GTQ218 installation
(GTQM218 similar)

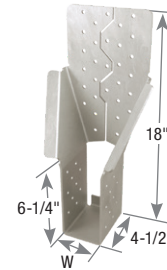

GTQ218
(GTQM218 similar)

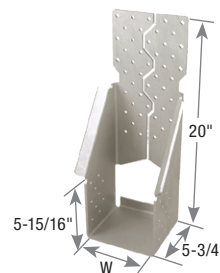

GTQ420
(GTQM420 similar)

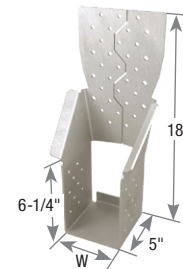

GTQ318
(GTQM318 similar)

MiTek Stock No.	Ref. No.	W (in)	Install Type	Min Vert Web Size	Fastener Schedule ^{1,3}						DF/SP Allowable Loads (Lbs.)					S-P-F Allowable Loads (Lbs.)					Code Ref.
					Supporting Truss ^{4,5}			Supported Truss			Allowable Loads (Lbs.)					Allowable Loads (Lbs.)					
					Qty	Type ⁵	Min. No. of Plies	Qty ⁶	Type	No. of Plies	Floor	Roof	Wind ⁸	Uplift ²	Floor	Roof	Wind ⁸	Uplift ²			
GTQ218	THGQ2-SDS3, THGQH2-SDS3	3-1/4	Min	2x6	18	WS3	2	20	WS3	2	100%	115%	125%	160%	160%	100%	115%	125%	160%	160%	--
			Max	2x8	30						6965	7900	7900	7900	4595	6225	6605	6605	6605	3845	
GTQM218 ⁷	THGQ3.62-SDS3, THGQH3.62-SDS3	3-5/8	Min	2x6	18	WS3	2	20	WS3	2	100%	115%	125%	160%	160%	100%	115%	125%	160%	160%	--
			Max	2x8	30						6965	7900	7900	7900	4595	6225	6605	6605	6605	3845	
GTQ318	THGQ3-SDS4.5, THGQH3-SDS4.5	4-7/8	Min	2x6	25	WS45	3	20	WS45	3	100%	115%	125%	160%	160%	100%	115%	125%	160%	160%	--
			Max	2x8	33						11480	11480	11480	11480	4595	10240	10240	10240	10240	3810	
GTQM318 ⁷	THGQ5.50-SDS4.5, THGQH5.50-SDS4.5	5-1/2	Min	2x6	25	WS45	3	20	WS45	3	100%	115%	125%	160%	160%	100%	115%	125%	160%	160%	--
			Max	2x8	33						14665	14665	14665	14665	4760	14500	14500	14500	14500	3945	
GTQ420	THGQH4-SDS6	6-1/2	Min	2x8	41	WS6	4	20	WS6	4	100%	115%	125%	160%	160%	100%	115%	125%	160%	160%	--
			Max	2x10	47						14435	14435	14435	14435	4690	14435	14435	14435	14435	3745	
GTQM420 ⁷	THGQH7.25-SDS6	7-1/4	Min	2x8	41	WS6	4	20	WS6	4	100%	115%	125%	160%	160%	100%	115%	125%	160%	160%	--
			Max	2x10	47						17600	17600	17600	17600	4690	15795	15795	15795	15795	3745	

- 1) MiTek's WS3 (1/4" dia. x 3" long), WS45 (1/4" dia. X 4-1/2" long, and WS6 (1/4" dia. x 6" long) structural wood screws are included with GTQ and GTQM hangers.
- 2) Uplift loads have been increased 60% for wind or seismic loads; no further increase shall be permitted.
- 3) MiTek's WS structural wood screws may be installed through metal truss connector plates as approved by truss designer per ANSI/TPI 1-2014 Section 7.5.3.4 and 8.9.2. Pre-drilling required through the plate using a maximum of 5/32" bit.
- 4) Truss plies of the supporting member must be fastened together to transfer the load (through all truss plies) that is not transferred by the hanger screws; fastening schedule is to be specified by the truss designer.
- 5) If the length of the screws going into the supporting truss are longer than the thickness of the plies, refer to the backer block installation on page 287.
- 6) MiTek's WS structural wood screws specified for supported member must ALL be installed into the supported member while maintaining a minimum 5/8" edge distance where truss connector plates are not present.
- 7) Supported members on GTQM hangers shall have Specific Gravity of not less than 0.46.
- 8) Wind (160%) is a download value.

Copyright © 2022 MiTek Industries, Inc. All Rights Reserved

Backer block installation

Wood blocking used to achieve full design load value of a face mount hanger attached to a carrying member. **Blocking to be designed by truss designer or engineer of record.**

- Wood blocking should be of similar size/grade as the truss member to which it is attached. The blocking should be designed to act as one unit with truss members.
- Truss designer shall approve blocking size/grade, fasteners required, and application.
- All fasteners used to attach wood blocking should be independent of the fasteners in the truss hanger.

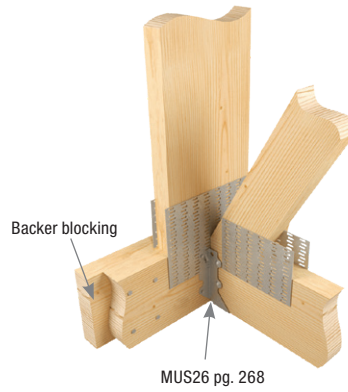

Panel point installation

- Connection with face mount hanger attaching to a truss panel point.
- Hanger nails that do not penetrate wood in panel point provide no load resistance.
- Reduce load according to the code.

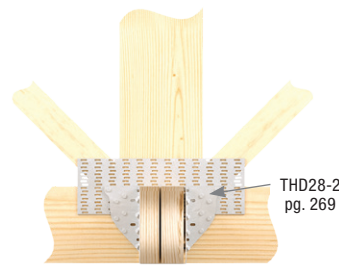

Filler block installation

Wood filler blocking used for supported member width less than hanger width.

Blocking and blocking fasteners/quantity to be designed by truss designer or engineer of record.

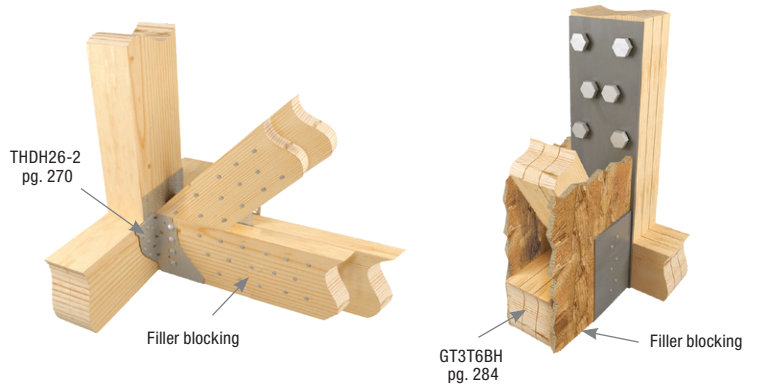

Truss Brace & Spacer (Stabilizer™)

Plated Truss

The Stabilizer™ Truss Brace & Spacer provides temporary construction bracing in the roof and ceiling planes, as well as permanent lateral bracing for webs as specified by your truss engineering.

The Stabilizer™ is easily installed by embedding the patented MII 20 teeth on the top flange straight into the edge of the truss member to be braced with a framing hammer. The side tabs are then secured by driving the teeth into the face of the truss member being braced.

Materials: 20 gauge
Finish: G60 galvanizing
Codes: IBC, FL

Installation:

- Use 31-16 for standard 16" o.c. spacing and 31-24 for standard 24" o.c. spacing. For odd spacing, cut and insert a solid block between the trusses.
- Typically, The Stabilizer™ is installed at 6'– 8' centers along the roof plane and 10'– 15' along the ceiling plane. (Refer to engineering specifications BCSI 1-03, published by The Truss Plate Institute for specific bracing requirements.)
- The Stabilizer™ must be supplemented with diagonal bracing in the roof and ceiling planes and cross bracing in the web plane at required intervals.
- Web forces are not to exceed 8000 lbs.
- The Stabilizer™ is properly installed when the top flap and side tabs are flush with the member being braced.

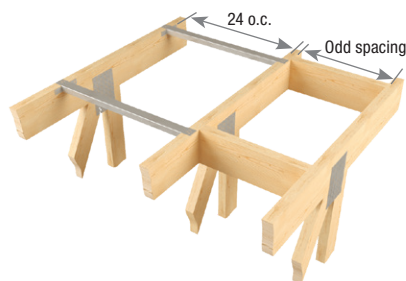

Temporary construction bracing installation

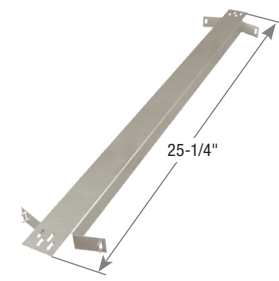

31-24 Stabilizer™



Side view

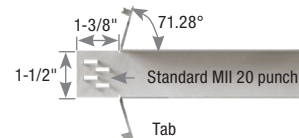

Top view

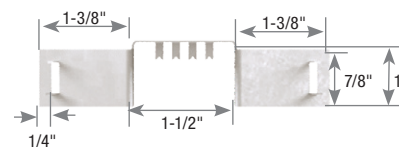

End view

Important: The erection contractor is responsible for determining and installing the temporary bracing for the structure, including the trusses. It is most important for the installer to provide adequate means for bracing the first truss installed. The performance of the entire bracing system depends on the adequacy of the ground bracing or other means of bracing the first group of trusses installed. The building designer is responsible for the permanent bracing design of the overall structure including the truss. This includes the design of required supplemental diagonal and cross bracing.

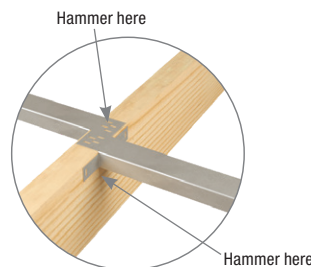

Chord attachment detail

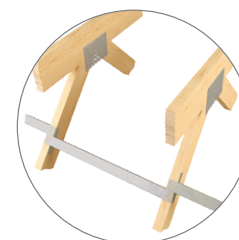

Web bracing installation

MiTek Stock No.	Ref. No.	Steel Gauge	O.C. Spacing (in)	Allowable Axial Loads (Lbs.)			Code Ref.
				Tension	Tension with Fastener	Compression	
31-16	TSBR2-16	20	16	105	155	420	IBC, FL
31-24	TSBR2-24	20	24	105	155	420	FL

- 1) 1 pound = 4.448N.
- 2) Fastener shall be (1) 8d or 10d common wire nail inserted through nail slot.
- 3) **NAILS:** 8d nails are 0.131" dia. x 2-1/2" long, 10d nails are 0.148" dia. x 3" long.

Truss spacers give framers fast and accurate spacing for trusses, rafters, or floor joists. The TS and TSX eliminate the need to mark layouts on bearing plates, improve installation speed, and help eliminate spacing errors. These spacers are light weight and compact.

Materials: See chart

Finish: G90 galvanizing

Installation:

- Use (1) 8d nail per end to fasten units to trusses, rafters, or floor joists.

Important: These units provide spacing guides only. Do not rely on the TS or TSX for bracing.

Joist Width (in)	MiTek Stock No. ¹	Ref. No.	Steel Gauge	O. C. Spacing	Overall Length	Sections Per Piece	Fastener Schedule		Code Ref.
							Qty	Type ²	
1-1/2	TS	--	20	24	2-ft 1-1/2"	1	2	8d	
1-1/2	TSX16	TSF2-16	22	16	8-ft	6	2	8d	--
1-1/2	TSX24	TSF2-24	22	24	10-ft	5	2	8d	

1) TSX spacers are shipped folded.

2) **NAILS:** 8d nails are 0.131" dia. x 2-1/2" long.



Typical TSX installation



TSX multi-unit spacer

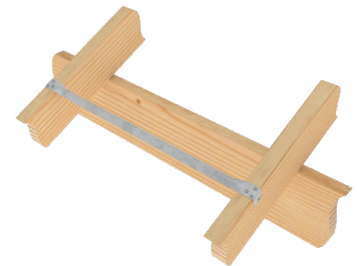

Typical TS installation



TS single-unit spacer

Use the SBP instead of extra truss plies or nail-on scabs to distribute concentrated truss reactions and avoid top plate crushing. The two-piece design accommodates any number of girder plies. A wraparound design gives superior uplift resistance, and reinforcement ribs effectively distribute bearing loads. Works with both single and double 2x4 or 2x6 top plates.

Materials: 16 gauge

Finish: G90 galvanizing

Codes: IBC, FL, LA

Installation:

- Use all specified fasteners. See Product Notes, page 18.
- **The SBP shall be installed in pairs.**

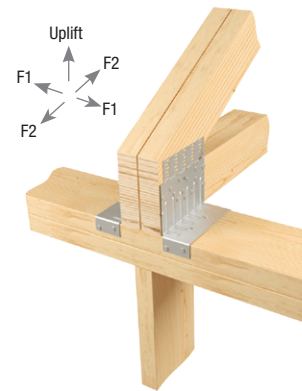

Typical SBP installation

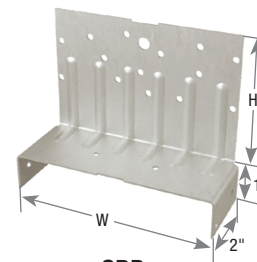

SBP

No. of Truss Pliers	Wood Species	F _c (psi)	Allowable Loads (Lbs.) ^{1,2,3}								
			SBP's Alone			SBP + Truss Bearing ⁴					
			100%	115%	125%	100%	EBL	115%	EBL	125%	EBL
SBP4 on 2 x 4 Top Plate (3-1/2" wide)											
1-Ply	DF	625	2500	2805	2955	5780	6.17	6085	6.49	6235	6.65
	SP	565	2745	2955	2955	5710	6.74	5920	6.99	5920	6.99
	S-P-F	425	2200	2365	2365	4430	6.95	4595	7.21	4595	7.21
	Hem Fir	405	2245	2445	2445	4370	7.19	4570	7.52	4570	7.52
2-Ply	DF	625	2500	2805	2955	9065	4.83	9370	5.00	9520	5.08
	SP	565	2745	2955	2955	8680	5.12	8890	5.24	8890	5.24
	S-P-F	425	2200	2365	2365	6665	5.23	6830	5.36	6830	5.36
	Hem Fir	405	2245	2445	2445	6500	5.35	6700	5.51	6700	5.51
3-Ply	DF	625	2500	2805	2955	12345	4.39	12650	4.50	12800	4.55
	SP	565	2745	2955	2955	11645	4.58	11855	4.66	11855	4.66
	S-P-F	425	2200	2365	2365	8895	4.65	9060	4.74	9060	4.74
	Hem Fir	405	2245	2445	2445	8625	4.73	8825	4.84	8825	4.84
4-Ply	DF	625	2500	2805	2955	15625	4.17	15930	4.25	16080	4.29
	SP	565	2745	2955	2955	14610	4.31	14820	4.37	14820	4.37
	S-P-F	425	2200	2365	2365	11125	4.36	11290	4.43	11290	4.43
	Hem Fir	405	2245	2445	2445	10750	4.42	10950	4.51	10950	4.51
SBP6 on 2 x 6 Top Plate (5-1/2" wide)											
1-Ply	DF	625	3500	3930	4235	8655	9.23	9085	9.69	9390	10.02
	SP	565	3845	4295	4295	8505	10.04	8955	10.57	8955	10.57
	S-P-F	425	3080	3415	3415	6585	10.33	6920	10.85	6920	10.85
	Hem Fir	405	3140	3525	3535	6480	10.67	6865	11.30	6875	11.32
2-Ply	DF	625	3500	3930	4235	13815	7.37	14245	7.60	14550	7.76
	SP	565	3845	4295	4295	13170	7.77	13620	8.04	13620	8.04
	S-P-F	425	3080	3415	3415	10095	7.92	10430	8.18	10430	8.18
	Hem Fir	405	3140	3525	3535	9825	8.09	10210	8.40	10220	8.41
3-Ply	DF	625	3500	3930	4235	18970	6.74	19400	6.90	19705	7.01
	SP	565	3845	4295	4295	17830	7.01	18280	7.19	18280	7.19
	S-P-F	425	3080	3415	3415	13600	7.11	13935	7.29	13935	7.29
	Hem Fir	405	3140	3525	3535	13165	7.22	13550	7.43	13560	7.44
4-Ply	DF	625	3500	3930	4235	24125	6.43	24555	6.55	24860	6.63
	SP	565	3845	4295	4295	22490	6.63	22940	6.77	22940	6.77
	S-P-F	425	3080	3415	3415	17105	6.71	17440	6.84	17440	6.84
	Hem Fir	405	3140	3525	3535	16505	6.79	16890	6.95	16900	6.95

- 1) Allowable loads are for a pair of SBP devices. SBPs shall be installed in pairs.
- 2) Multiple ply trusses shall be fastened together to act as a single unit.
- 3) EBL denotes effective bearing length in inches and includes the actual bearing length plus the contribution of the SBP device.
- 4) Assumes full seating of truss on top plate.

MiTek Stock No.	Ref. No.	Steel Gauge	Dimensions (in)		Joist Thickness (in)	Fastener Schedule ^{1,6}				DF/SP Allowable Loads (Lbs.) ^{2,3}			S-P-F Allowable Loads (Lbs.) ^{2,3}			Code Ref.	
			W	H		Plate		Truss		Uplift ⁴ 160%	F1 160%	F2 160%	Uplift ⁴ 160%	F1 160%	F2 160%		
						Top Qty	Sides Qty	Type	Qty								Type
SBP4	TBE4	16	3-1/2	3-1/4	2-7/8 or less 3 or more	4	8	10d	20	10d x 1-1/2	1205	1530	1625	820	1195	1335	IBC, FL, LA
									28	10d							
SBP6	TBE6	16	5-1/2	3-1/4	2-7/8 or less 3 or more	4	8	10d	20	10d x 1-1/2	1205	1530	1625	820	1195	1335	IBC, FL, LA
									28	10d							

- 1) Fastener Schedule is for a pair of SBP devices.
 - 2) Allowable loads are for a pair of SBP devices. SBPs shall be installed in pairs.
 - 3) Multiple ply trusses shall be fastened together to act as a single unit.
 - 4) Uplift loads have been increased 60% for wind or seismic loads; no further increase shall be permitted.
 - 5) **Other connector models are not to be combined with SBP to resist the uplift force or lateral loads. For special considerations, consult MiTek Customer Service.**
 - 6) **NAILS:** 10d x 1-1/2 nails are 0.148" dia. x 1-1/2" long, 10d nails are 0.148" dia. x 3" long.
- New products or updated product information are designated in **blue font**.

FTC clips slide easily onto the top or bottom chord and provides a guide to help position and support the second truss during assembly

FTCF clips easily install after the trusses are installed

- Materials:** 18 gauge
- Finish:** G90 galvanizing
- Codes:** IBC, FL, LA
- Patents:** U.S. Patent No. 5,653,079

Installation:

- Use all specified fasteners. See Product Notes, page 18.
- The truss designer must determine the number of clips required and the spacing between clips based on loading conditions.

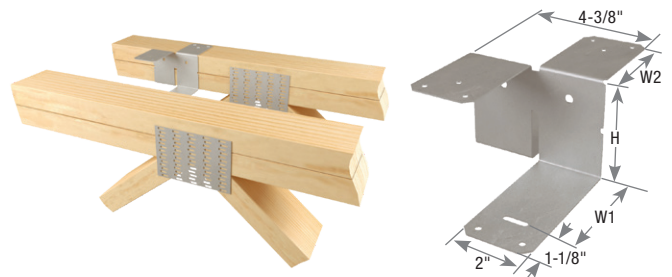

Typical FTC installation

FTC



Typical FTC 2-ply metal web truss installation

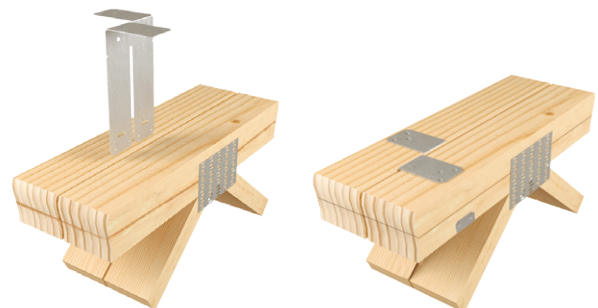

Step 1

Typical FTC2F retrofit installation

Step 2

Concentrated Load Condition: (side load attached to 2-ply truss):

The FTC clips shall be installed in pairs, or multiples of two, on either side of, and within 12" of a concentrated load.

Divide half of the concentrated load by the clip load transfer capacity to determine the number of clips required.

Example:

Concentrated (point) load = 3000 lbs, FTC1 capacity (DF/SP) = 865 lbs

$$\frac{1/2 (3000 \text{ lbs})}{865 \text{ lbs}} = 1.73 = 2 \text{ clips}$$

Place 2 clips near concentrated load

Uniform Load Condition: (side load attached to 2-ply truss):

To transfer uniform loads to the second ply, the FTC clips shall be installed at a regular interval along the loaded chord. Spacing between clips is limited to 24" maximum.

Divide the clip load transfer capacity by half the required load per lineal foot (PLF) to determine the spacing between clips.

Example:

Uniformly (distributed) load = 500 PLF, FTC1 capacity (DF/SP) = 865 lbs

$$\frac{865 \text{ lbs}}{1/2 (500) \text{ PLF}} = 3.46' \text{ spacing}$$

Since 3.46' is greater than 24" (MAX), space clips at 24" along the loaded chord.

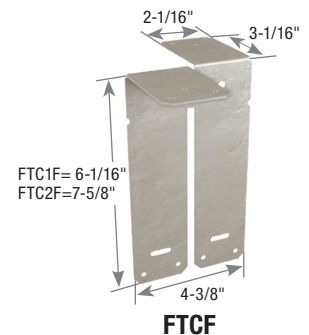

FTCF

Truss Size	MiTek Stock No.	Ref. No.	Steel Gauge	Dimensions (in)			Fastener Schedule ³		DF/SP Maximum Transfer Loads ^{1,2}	S-P-F Maximum Transfer Loads ^{1,2}	Code Ref.
				W1	W2	H	Qty	Type			
3 x 2	FTC32	--	18	2-1/16	2-1/2	1-1/2	10	10d x 1-1/2	680	590	IBC, FL, LA
4 x 2	FTC1	--	18	3-1/2	3-1/16	1-1/2	10	10d	865	750	
	FTC1F	--	18	3-1/16	--	4-3/8	10	10d	865	750	
(2) 4 x 2	FTC2	--	18	3-1/2	3-1/16	3	10	10d	865	750	
	FTC2F	--	18	3-1/16	--	4-3/8	10	10d	865	750	

1) Transfer loads are for 100% floor load, and shall not be increased for short term load duration.
 2) Truss designer shall determine the number of clips for concentrated loads and the spacing for uniform loads.
 3) **NAILS:** 10d x 1-1/2 nails are 0.148" dia. x 1-1/2" long, 10d nails are 0.148" dia. x 3" long.

VTT Valley Truss Tie is designed to transfer loads from a valley truss into the supporting structure below. It also resists the sliding forces from downward loads when the valley truss is set upon a sloped lower roof. The ability to resist the sliding force eliminates the need for support wedges under the valley truss bottom chord or special order valley roof trusses with a bevel-cut bottom chord.

- Double-dimple nail holes assure the nails are driven in at the correct angle into the supporting member every time.
- Flat design requires no field bending to match the supporting roof pitch.
- 2-Ply steel with stiffening ribs provides a high resistance to sliding forces from downward loads.
- Prong teeth help hold the VTT in place while nailing.
- Accommodates supporting roof pitches from 0/12 to 12/12.
- Pitch guide embossments allow attachment to valley truss on ground.

Materials: 18 gauge

Finish: G90 galvanizing

Patents: U.S. Patent No. 9,920,514 B1

Installation:

- Mark the location of the supporting truss located below the lower roof sheathing.
- Place the VTT flat against the valley truss, centered over the top chord of the truss below. Tap the top edge down with a hammer to engage the prong teeth.
- Nail the VTT to the bottom chord of the valley truss using (3) 10d (0.148") x 1-1/2" nails.
- Install (3) 10d (0.148" x 3") common nails through the double-dimples and drive them through the sheathing into the top chord of the supporting truss below. One nail will be centered in the top chord below. The other two nails are driven in at preset angles guided by the dimple holes.

Alternate Installation for Ground/Pre-Placement of VTT

- Mark the location of the supporting truss located below the lower roof sheathing. Center VTT horizontally on that mark.
- Use pitch guide embossments on part to locate the vertical position of VTT. Pitch numbers on connector are the numerator in the pitch slope ratio. (i.e. "6" indicates a 6/12 pitch, "12" indicates a 12/12 pitch, etc.)
- Secure the VTT to valley truss with (3) 10d (0.148") x 1-1/2" nails.
- When valley truss is hoisted into proper position on roof, install (3) 10d (0.148" x 3") common nails through the double-dimples and drive them through the sheathing into the top chord of the supporting truss below. One nail will be centered in the top chord below. The other two nails are driven in at a preset angles guided by the dimple holes.

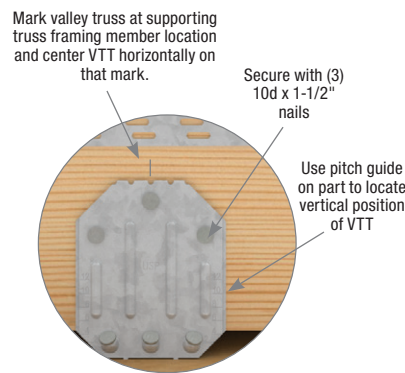
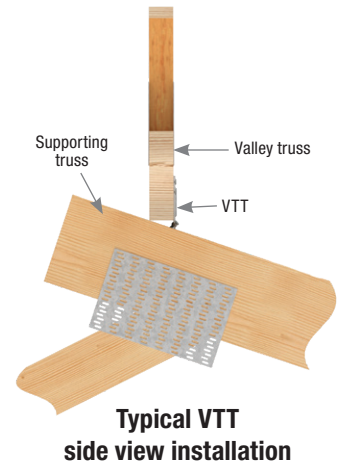
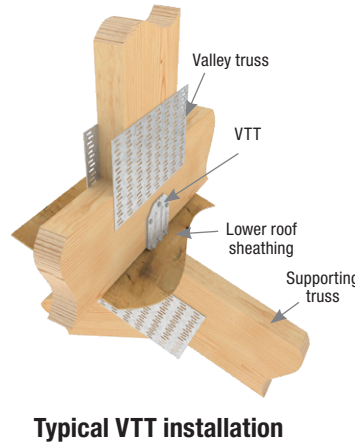
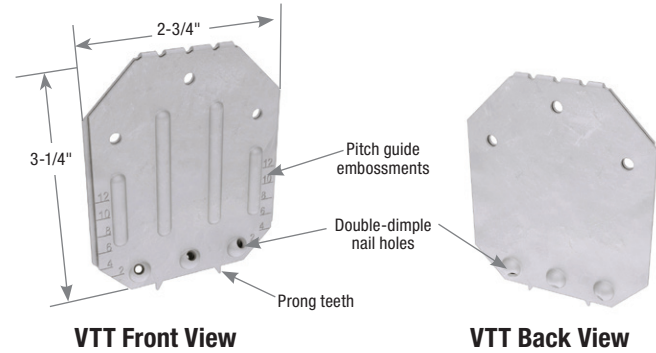

Alternate Installation for Ground / Pre-Placement installation

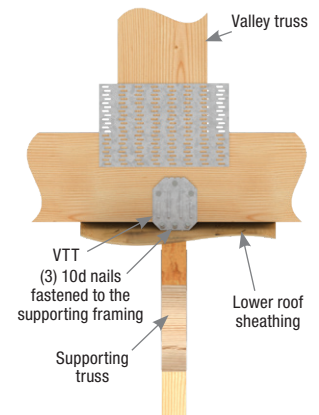

Typical VTT front view installation

MiTek Stock No.	Ref. No.	Steel Gauge	Dimensions (in)		Fastener Schedule ⁴				Supporting Roof Pitch	DF/SP Allowable Loads (Lbs.)		S-P-F Allowable Loads (Lbs.)		Code Ref.
			W	H	Supporting Framing		Valley Truss			Download ³	Uplift ^{1,2}	Download ³	Uplift ^{1,2}	
					Qty	Type	Qty	Type						
VTT	VTCR	18	2-3/4	3-1/4	3	10d	3	10d x 1-1/2	< 4/12	840	375	685	270	
									4/12 to < 8/12	840	445	685	325	--
									8/12 to 12/12	840	480	685	400	

1) Uplift Loads have been increased 60% for wind or seismic loads; no further increase shall be permitted.
 2) Uplift loads are based on installation over 7/16" or 15/32" sheathing.
 3) Downloads have been increased for snow, construction and wind loads; no further increase shall be permitted.
 4) **NAILS:** 10d x 1-1/2 nails are 0.148" dia. x 1-1/2" long, 10d nails are 0.148" dia. x 3" long.

The STC provides uplift resistance by securing trusses to top plates. Slotted nail holes allow for horizontal movement as scissor trusses deflect.

Materials: 12 gauge
Finish: G90 galvanizing
Codes: IBC, FL, LA

- Installation:**
- Use all specified fasteners. See Product Notes, page 18.
 - When installing, do not fully set nails.
 - Locate nails into the center of slots to allow for horizontal movement.

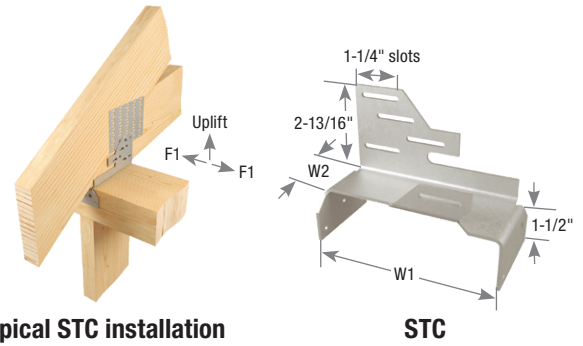

Typical STC installation

STC

MiTek Stock No.	Ref. No.	Steel Gauge	Description	Dimensions (in)		Fastener Schedule ²				DF/SP Allowable Loads (Lbs.)		S-P-F Allowable Loads (Lbs.)		Code Ref.
				W1	W2	Truss		Plate		Uplift ¹ 160%	F1 160%	Uplift ¹ 160%	F1 160%	
						Qty	Type	Qty	Type					
STC24	TC24	12	2 x 4 top plate	3-9/16	1-5/8	5	10d x 1-1/2	6	10d x 1-1/2					IBC, FL, LA
STC26	TC26	12	2 x 6 top plate	5-1/2	1-5/8	5	10d x 1-1/2	6	10d x 1-1/2	465	605	410	470	
STC28	TC28	12	2 x 8 top plate	7-1/4	1-5/8	5	10d x 1-1/2	6	10d x 1-1/2					

1) Uplift loads have been increased 60% for wind or seismic loads; no further increase shall be permitted.
 2) **NAILS:** 10d x 1-1/2 nails are 0.148" dia. x 1-1/2" long.

TR Roof Truss Ties

Slotted design allows truss to deflect without imposing load on wall below.

Materials: See chart
Finish: G90 galvanizing

- Installation:**
- Use all specified fasteners. See Product Notes, page 18.
 - Do not fully set nails.
 - Locate nails into the center of slots.
 - **Due to the potential for squeaks, the TR series products are not recommended for floor applications.**

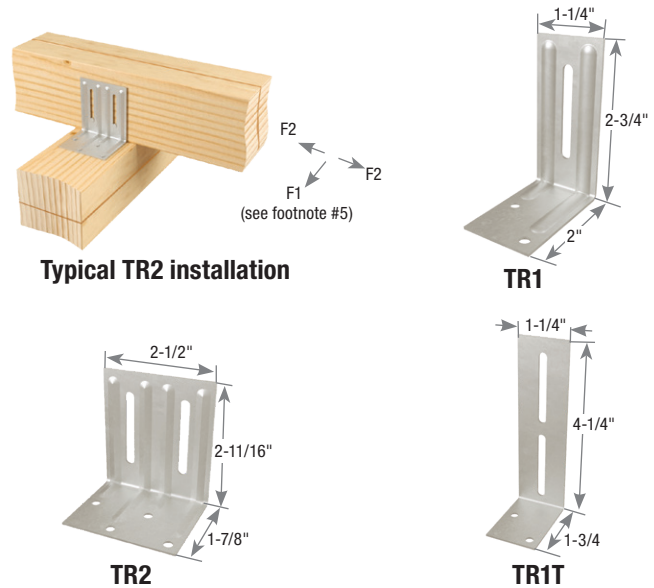

Typical TR2 installation

TR1

TR2

TR1T

MiTek Stock No.	Ref. No.	Steel Gauge	Description	Fastener Schedule ⁶				DF/SP Allowable Loads (Lbs.) ¹						Code Ref.
				Truss		Plate		Without Gap ²		With 1/4" Gap ³		With 1/2" Gap ⁴		
				Qty	Type	Qty	Type	F1 ⁵ 160%	F2 160%	F1 ⁵ 160%	F2 160%	F1 ⁵ 160%	F2 160%	
TR1	STC	18	single slot	1	8d	2	8d	85	50	35	35	--	--	
TR1T	STCT	16	single slot	1	8d	2	8d	240	--	130	--	80	--	--
TR2	DTC	18	double slot	2	8d	4	8d	125	210	85	135	--	--	

1) Loads have been increased for short-term loading; no further increase allowed.
 2) Truss must be bearing on top plate to achieve the allowable loads under "Without Gap".
 3) Installed with maximum 1/4" space between rafter or truss and top plate under "With 1/4" Gap". Space is not limited to 1/4", where loads are not required.
 4) Installed with maximum 1/2" space between rafter or truss and top plate under "With 1/2" Gap". Space is not limited to 1/2", where loads are not required.
 5) To achieve F1 loads in both directions, clips must be installed on both sides of the truss and staggered to avoid nail interference.
 6) **NAILS:** 8d nails are 0.131" dia. x 2-1/2" long.

Slotted design allows truss to deflect without imposing load on wall below.

Materials: 16 gauge
Finish: G90 galvanizing
Codes: IBC, FL, LA

Installation:

- Use all specified fasteners. See Product Notes, page 18.
- Do not fully set nails.

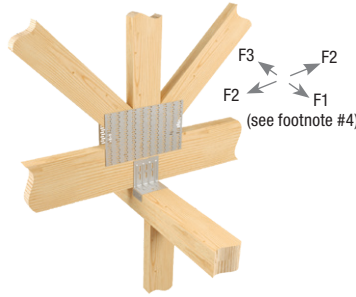

Typical HTC4 installation

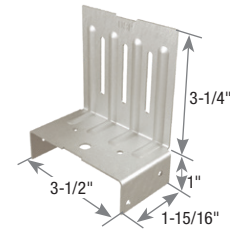

HTC4

MiTek Stock No.	Ref. No.	Steel Gauge	Fastener Schedule ⁴			Type	DF/SP Allowable Loads (Lbs.) ¹						Code Ref.
			Plate		Truss/Rafter		Without Gap ²			With 1-1/4" Gap ³			
			Top Qty	Side Qty			F1 ⁵ 160%	F2 160%	F3 160%	F1 ⁵ 160%	F2 160%	F3 160%	
			Qty	Qty	Qty		Qty	Qty	Qty	Qty			
HTC4	HTC4	16	2	4	3	10d x 1-1/2	655	450	220	235	285	115	IBC, FL, LA

- 1) Loads have been increased 60% for wind or seismic loads; no further increase shall be permitted.
 - 2) Truss/Rafter must be bearing on top plate to achieve the allowable loads under "Without Gap".
 - 3) When installed with maximum 1-1/4" space between truss/rafter and top plate, use loads under "With 1-1/4" Gap".
 - 4) To achieve F1 loads in both directions, clips must be installed on both sides of the truss and nails staggered to avoid nail interference.
 - 5) **NAILS:** 10d x 1-1/2 nails are 0.148" dia. x 1-1/2" long.
- New products or updated product information are designated in **blue font**.

ZC Blocking Supports

ZC clips secure blocking between joists or trusses which provides support for drywall or sheathing.

Materials: See chart
Finish: G90 galvanizing

Installation:

- Use all specified fasteners. See Product Notes, page 18.



Typical ZC installation

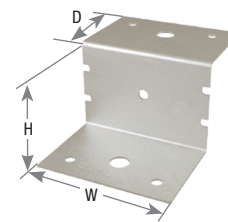

ZC2

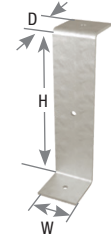

ZC4

MiTek Stock No.	Ref. No.	Steel Gauge	Dimensions (in)			Fastener Schedule ²				DF/SP Allowable Loads (Lbs.) ¹	Code Ref.
			W	H	D	Header		Blocking			
						Qty	Type	Qty	Type	Download 100%	
ZC2	Z2	20	2-1/4	1-9/16	1-1/2	2	10d x 1-1/2	2	10d x 1-1/2	490	--
ZC4	Z4	12	1-1/2	3-9/16	1-3/8	2	10d x 1-1/2	1	10d x 1-1/2	420	
ZC24	Z28	28	2-9/32	1-9/16	1-3/8	10d x 1-1/2	10d x 1-1/2			--	
ZC34	Z38	28	2-9/32	2-9/16	1-5/16	10d x 1-1/2	10d x 1-1/2			--	

- 1) Allowable load shall not be increased for other load duration factors.
- 2) **NAILS:** 10d x 1-1/2 nails are 0.148" dia. x 1-1/2" long.

T Hoist Plates

Engineered with a reinforced collar around the hoist hole for added strength.

Materials: 14 gauge
Finish: G90 galvanizing

Installation:

- Fill all nail holes that align with wood.



Typical T10 installation

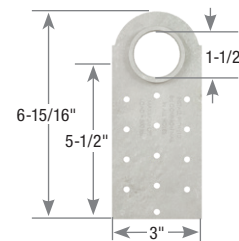

T10

MiTek Stock No.	Ref. No.	Steel Gauge	Fastener Schedule ²		Max 125% Load (Lbs.) ¹	Code Ref.
			Min. Qty	Type		
T10	CHC	14	10	8d common	800	--

- 1) Allowable load shall not be increased for other load duration factors.
- 2) **NAILS:** 8d nails are 0.131" dia. x 2-1/2" long.

FS / FSS Truss Field Splice Kits

Plated Truss

Job site splicing of long trusses is made easier with Truss Field Splice Kits. The FS and FSS (for scissors trusses) includes a pair of plates, bolts, nuts, and a Splice Clip for top chord alignment. Allowable loads are sometimes limited by tension in the net section of the wood. Choose the bottom chord size and species that will satisfy the tension requirement. Analyze tension in the web to determine the required size.

Materials: FS/FSS – See chart, bolts, and nuts included Splice Clip – 12 gauge

Finish: FS & FSS – Primer; Splice Clip – G90 galvanizing; Bolts – zinc plating

Installation:

- Use all specified fasteners. See Product Notes, page 18.
- Position the two trusses, center one splice plate on the bottom chords and clamp in place for a drilling template. Install the Splice Clip at the top truss plate and fasten with (18) 10d (0.148" dia) x 1-1/2" nails. Drill through the bottom chord using splice plate as a template. Place splice plate on each side and bolt the connection firmly.

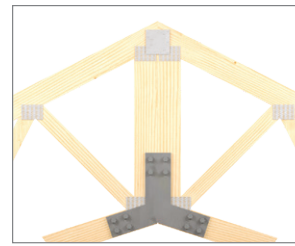

Typical FSS installation

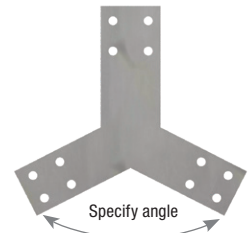

FSS

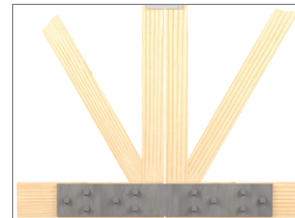

Typical FS installation

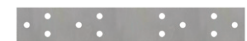

FS



Splice Clip

MiTek Stock No.	Ref. No.	Steel Gauge	Truss Plies	Bolt Schedule		Chord Size	Allowable Loads (Lbs.) ^{1,2}			Code Ref.
				Qty	Size (in)		DF	SP	S-P-F	
							115%	115%	115%	
FS8B	--	7	1	8	3/4 x 3	2 x 6	4995	4845	3910	--
						2 x 8	6695	6305	5240	
						2 x 10	7195	7565	6030	
FS8B-2	--	7	2	8	3/4 x 5	2 x 6	9995	9690	7820	--
						2 x 8	13390	12615	10480	
						2 x 10	14130	14725	12140	
FS8B-3	--	7	3	8	3/4 x 7	2 x 6	14120	14540	11730	--
						2 x 8	14145	14740	13070	
						2 x 10	14130	14725	13075	
FS12B	--	3	1	12	3/4 x 3	2 x 6	4995	4845	3910	--
						2 x 8	6695	6305	5240	
						2 x 10	8320	7565	6510	
FS12B-2	--	3	2	12	3/4 x 5	2 x 6	9995	9690	7820	--
						2 x 8	13390	12615	10480	
						2 x 10	16640	15125	13020	
FS12B-3	--	3	3	12	3/4 x 7	2 x 6	14990	14540	11730	--
						2 x 8	20085	18920	15720	
						2 x 10	21770	22670	19530	
FSS8B	--	7	1	12	3/4 x 3	2 x 6	4995	4845	3910	--
						2 x 8	6695	6305	5240	
						2 x 10	7195	7565	6030	
FSS8B-2	--	7	2	12	3/4 x 5	2 x 6	9995	9690	7820	--
						2 x 8	13390	12615	10480	
						2 x 10	14130	14725	12140	
FSS12B	--	3	1	18	3/4 x 3	2 x 6	4995	4845	3910	--
						2 x 8	6695	6305	5240	
						2 x 10	8320	7565	6510	
FSS12B-2	--	3	2	18	3/4 x 5	2 x 6	9995	9690	7820	--
						2 x 8	13390	12615	10480	
						2 x 10	16640	15125	13020	

Plated Truss

Copyright © 2022 MiTek Industries, Inc. All Rights Reserved

- 1) Allowable loads shall not be increased for other load duration factors.
- 2) Allowable loads are based on the lesser of the calculated bolt loads and the calculated wood tensile strength at the critical net section.
- 3) Wood tensile strengths are based on the Ft of 450 psi for S-P-F, 575 psi for DF-L, and approximately 540 psi for SP; and increased by the size factors in accordance with the NDS®.
- 4) Bolts shall conform to ASTM A 307 Grade A or better.

DECK & FENCES



DECK & FENCES

298-305

Angles	302
Deck Connectors	298-300
Fence Hardware	303-305
Stair Angles	301

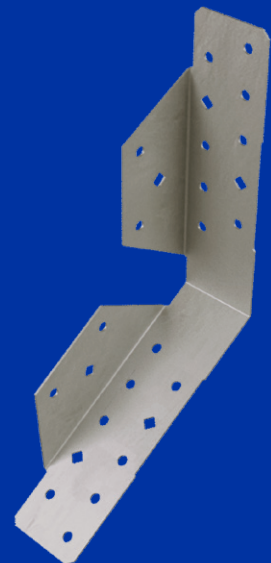

Deck collapses are often caused by failure of the connection where the deck is attached to the main structure due to little or no lateral capacity. ADTT-TZ is an Adjustable Deck Tension Tie designed to effectively transfer the out of plane lateral loads of the deck to the house structure.

Features:

- Exceeds "Hold-down Device" requirements per 2018 IRC, Section 507.9.2 [Figure R507.9.2(2)]
- Adjustable design allows lag screw installation at variable distance below deck joist
- 2-hole break-out washer (BO-W) will work with multiple screw sizes
- Blocking extensions not required

Materials: 14 gauge

Finish: G-185 galvanizing

Codes: See chart for code references

Patents: U.S. Patent No. 9,809,974

Installation:

- Install with MiTek WS8-EXT structural wood screw or 3/8" HDG lag screw. WS8-EXT or 3/8" HDG lag screws may be installed adjacent or up to 4-3/8" below deck joist (see Figure A).
- Drive screw horizontally and aligned vertically with the deck joist into the wall top plate of the main (house) structure.
- Install four (4) of the specified joist fasteners into vertical legs. (Two (2) on each side of deck joist).
- Secure front brace with six (6) specified joist fasteners.
- Re-tighten the WS8-EXT or 3/8" HDG lag screw as needed to fully engage with the ADTT-TZ. **DO NOT OVERDRIVE.** Note: Minimum 3" thread penetration required for proper installation of WS8-EXT or HDG lag screw.
- For detailed installation instructions refer to MiTek-US.com.

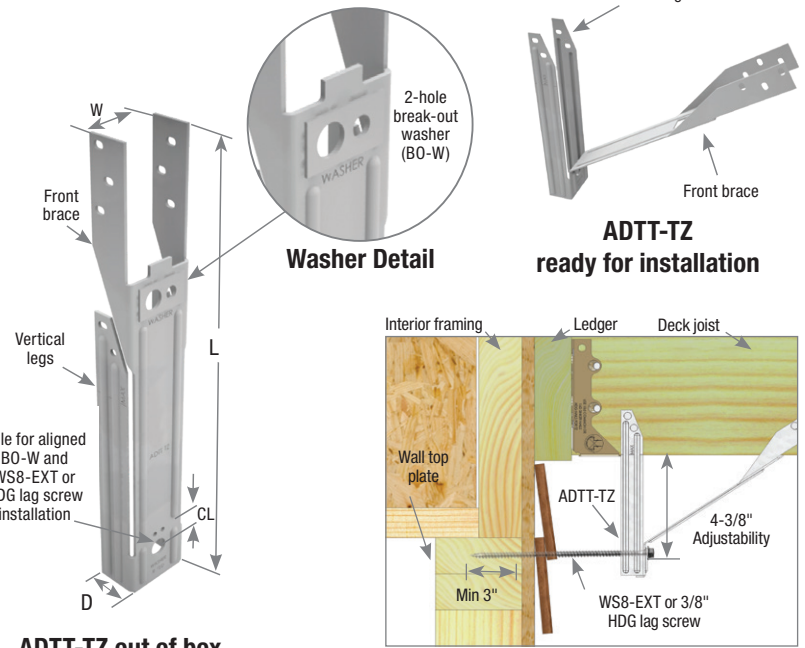
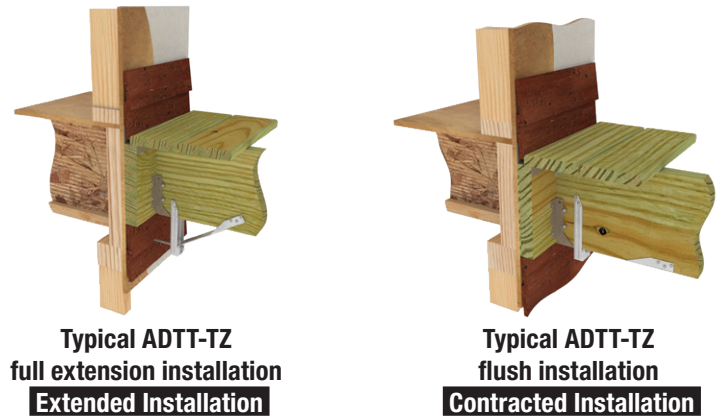

Figure A

MiTek Stock No.	Ref. No.	Steel Gauge	Dimensions (in)				Fastener Schedule				Installation Type ¹	DF/SP Allowable Tension (Lbs.)		S-P-F Allowable Tension (Lbs.)		Corrosion Finish	Code Ref.
			W	L	D	CL	Wall		Joist			160%	Δ (in) at 160% ²	160%	160%		
							Qty	Type ^{3,4,5}	Qty	Type ^{6,8}							
ADTT-TZ	DTT1Z	14	1-9/16	10-1/2	15/16	3/8	1	3/8" HDG Lag Screw	10	10d x 1-1/2 HDG	Contracted	820	0.070	820	IBC, FL, LA		
									10	LL915	Extended	850	0.117	810			
									10	LL915	Contracted	820	0.121	780			
									10	LL915	Extended	790	0.114	780			
							1	WS8-EXT	10	10d x 1-1/2 HDG	Contracted	830	0.080	780			
									10	LL915	Extended	835	0.113	780			
									10	LL915	Contracted	830	0.121	780			
									10	LL915	Extended	790	0.114	780			
ADTT-TZKT ⁷	DTT1Z-KT	14	1-9/16	10-1/2	15/16	3/8	1	WS8-EXT	10	LL915	Contracted	830	0.121	780	--		
											Extended	790	0.114	780	--		

1) Allowable loads are for the ADTT-TZ installed tight to the bottom of the joist (Contracted) or 4" from bottom of joist to ADTT-TZ bend line (Extended).
 2) Deflections are derived from static, monotonic load tests of devices connected to DF wood members with specified fasteners.
 3) WS8-EXT is a 1/4" dia. x 8" long double barrier coated screw sold by MiTek and must be ordered separately if not purchasing the kit. The minimum thread penetration into the top plate of the wall framing is 3".
 4) 3/8" HDG Lag Screw is an ASTM A307 Grade A lag screw with a thread diameter of 3/8" and is hot-dip galvanized to ASTM A153 standards. The minimum thread penetration into the top plate of the wall framing is 3". Lag screws are available at your local hardware store and must be purchased separately.

5) Check with your siding manufacturer for recommendations for fastening through your siding material.
 6) LL915 denotes a MiTek LumberLok Screw (#9 x 1-3/8" long) and must be ordered separately if not purchasing the kit.
 7) ADTT-TZKT is a kit with (4) ADTT-TZ packaged with MiTek WS8-EXT structural wood screws and LL915 LumberLok screws.
 8) **NAILS:** 10d x 1-1/2 nails are 0.148" dia. x 1-1/2" long.

Corrosion Finish Key ■ Stainless Steel ■ Gold Coat ■ HDG ■ Triple Zinc

Deck Tie Back reinforces the connection of rail posts to a deck. Also provides lateral strength of deck-to-ledger attachment by securing deck to house framing.

Materials: 14 gauge

Finish: G-185 galvanizing

Options: See chart for Corrosion Finish Options

Codes: IBC, FL, IRC R507.1

Installation:

- Use all specified fasteners. See Product Notes, page 18.
- Install with MiTek's THR 1/2" threaded rod or equivalent.
- Drive MiTek's WS15-EXT structural wood screws into joist.
- Re-install threaded rod or anchor bolt. Secure with washer and nut.
- Tighten anchor bolt nuts finger tight to base plus 1/3 to 1/2 additional turns with wrench.



Typical DTB-TZ rail post installation

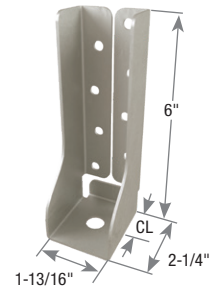

DTB-TZ



Typical DTB-TZ deck to ledger installation

MiTek Stock No.	Ref. No.	Steel Gauge	Dimensions (in)				Fastener Schedule				Allowable Loads (Lbs.)			Corrosion Finish	Code Ref.
			W	L	D	CL	Wall		Joist		DF/SP	S-P-F	Deflection Δ (in) at 160% ²		
							Qty	Bolt ³	Qty	Screws ¹	Tension 160%	Tension 160%			
DTB-TZ	DTT2Z, FSC	14	1-13/16	6	2-1/4	1-1/8	1	1/2	8	WS15-EXT	1835	1510	0.119	Green/Blue	IBC, FL

1) MiTek's WS15-EXT structural wood screws are 1/4" dia. x 1-1/2" long and are included with DTB-TZ Deck Tie-Backs.
 2) Deflections are derived from static, monotonic load tests of devices connected to DF wood members with specified fasteners.
 3) Minimum ASTM A307 bolt or 1/2" threaded rod with cut washer and hex nut.

Corrosion Finish Key ■ Stainless Steel ■ Gold Coat ■ HDG ■ Triple Zinc

The CSH-TZ concealed stringer hanger provides a method of connecting a stair stringer with a hidden hanger. The seat of the hanger is adjustable to match the slope of the stair stringer.

The reversible design allows the connector to be used on the left, right, or interior stringers. The CSH-TZ may be used with MiTek's SCA Stair Angles for a complete, easy-to-use stair framing solution.

Materials: 18 gauge

Finish: G-185 galvanizing

Options: See chart for Corrosion Finish Options

Codes: IBC, FL, LA

Patents: U.S. Patent No. 7,631,463

Installation:

- Use all specified fasteners. See Product Notes, page 18.
- **Bend angle only once.**

Steps:

1. Attach CSH-TZ to header with tabs positioned towards the inside of the stringer member.
2. Adjust the seat of the CSH-TZ to match the slope of the stringer member. Diamond shaped holes in the connector allow temporary installation of wood screws to aid in installation of the CSH-TZ.
3. Install 10d (0.148") x 1-1/2" HDG nails into the stringer and rim/band joist.

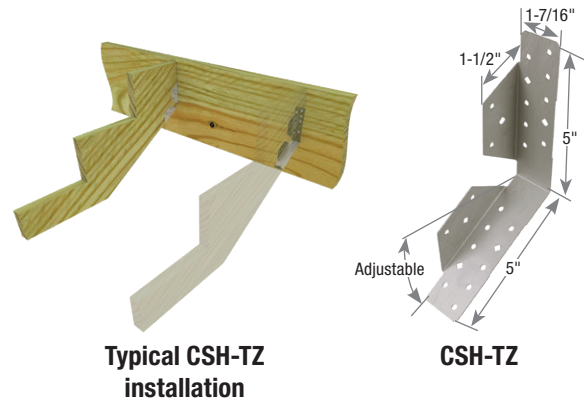

MiTek Stock No.	Ref. No.	Steel Gauge	Fastener Schedule ^{2,3}					DF/SP Allowable Loads (Lbs.)				S-P-F/Hem Fir Allowable Loads (Lbs.)				Corrosion Finish	Code Ref.
			Rim/Band Joist		Stringer			100%	115%	125%	Uplift 160%	100%	115%	125%	Uplift 160%		
			Qty	Type	Wide Face Qty	Narrow Face Qty	Type										
CSH-TZ	LSCZ	18	8	10d x 1-1/2 HDG	4	1	10d x 1-1/2 HDG	875	875	875	370	695	695	695	295	IBC, FL, LA	

- 1) Uplift loads are increased 60% for wind or seismic loads; no further increase shall be permitted.
- 2) Stainless steel ring shank nails must be used with stainless steel connectors to achieve tabulated allowable loads.
- 3) **NAILS:** 10d x 1-1/2 HDG nails are 0.148" dia. x 1-1/2" long. New products or updated product information are designated in **blue font**.

Corrosion Finish Key ■ Stainless Steel ■ Gold Coat ■ HDG ■ Triple Zinc

Stair angles simplify stair construction. There is no need to calculate and notch stair stringers. Stronger and safer than wood blocking, and the angle and fasteners are hidden from view.

Materials: 12 gauge

Finish: G-185 galvanizing

Options: See chart for Corrosion Finish Options

Installation:

- Use all specified fasteners. See Product Notes, page 18.
- MiTek WS15-EXT (1/4" dia. x 1-1/2" long) structural wood screws are not supplied with SCA angles.
- Use the SCA9-TZ for single 2x10 stair treads. Use the SCA10-TZ for double 2 x 6 stair treads.
- To calculate stair construction do the following:
 1. Find the number of steps needed by dividing the vertical drop in inches from the deck surface to grade by 7. Round off to the nearest whole number. (Ex: Vertical drop of 39" divided by 7" equals 5.57 rounded off is 6)
 2. Find the step rise by dividing the vertical drop by the number of steps (39" divided by 6 = 6.5")
 3. Find the step run by measuring the depth of your tread board (Ex: (2) 2x6s with 1/4" gap will have a run of 11-1/4")
 4. Find the stairway span by multiplying the run by the number of treads minus one (Ex: 11-1/4" x 5 = 56-1/4")
- Using the above calculations, mark stair angle locations on each stringer. Attach a stair angle to the inside of each stringer at the marked locations. Attach stringers to deck rim joist and railing posts. Position treadboards on angles and fasten from below.



Typical SCA9-TZ installation

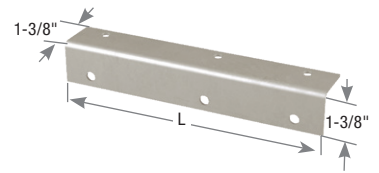

SCA9-TZ



Typical SCA10-TZ installation



MiTek Stock No.	Ref. No.	Steel Gauge	L (in)	Fastener Schedule ^{2,3}		DF/SP Allowable Loads (Lbs.) ¹		Corrosion Finish	Code Ref.
				Qty	Type	Download 100%			
SCA9-TZ	TA9Z	12	9	6	WS15-EXT	445			--
SCA10-TZ	TA10Z	12	10	8	WS15-EXT	595			

1) Loads assume rise over run of 7/11.

2) MiTek's WS15-EXT structural wood screws are 1/4" dia. x 1-1/2" long and are not included with SCA angles.

3) HDG lag screws may be substituted for specified WS15-EXT structural wood screws with no load reduction.

Corrosion Finish Key ■ Stainless Steel ■ Gold Coat ■ HDG ■ Triple Zinc

ML angles are multi-purpose angles that install easily with MiTek's WS15 structural wood screws. The staggered fastener pattern allows for back-to-back installations.

Materials: 12 gauge

Finish: G-185 galvanizing

Options: See chart for Corrosion Finish Options

Codes: IBC, FL, LA

Installation:

- Use all specified fasteners. See Product Notes, page 18.
- MiTek's WS15 (1/4" dia x 1-1/2" long) structural wood screws are not supplied with ML angles.



Typical ML26-TZ installation
(ML24-TZ similar)

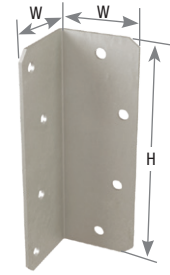

ML26-TZ
(ML24-TZ similar)

MiTek Stock No.	Ref. No.	Steel Gauge	Dimensions (in)		Fastener Schedule ^{2,3}			DF/SP Allowable Loads (Lbs.) ¹				S-P-F Allowable Loads (Lbs.) ¹				Corrosion Finish	Code Ref.
			W	H	Header Qty	Joist Qty	Type	F1				F1					
								100%	115%	125%	160%	100%	115%	125%	160%		
ML24-TZ	ML24Z	12	2	4	3	3	WS15	655	655	655	655	565	650	655	655	Green/Blue	IBC, FL, LA
ML26-TZ	ML26Z	12	2	6	4	4	WS15	920	1060	1090	1090	755	865	940	1090		

1) Allowable loads have been increased 60% for wind and seismic loads; no further increase shall be permitted.

2) MiTek's WS15 structural wood screws are 1/4" dia. x 1-1/2" long and are not included with angles.

3) For exterior applications use MiTek's WS15-EXT structural wood screws with exterior coat finish.

Corrosion Finish Key ■ Stainless Steel ■ Gold Coat ■ HDG ■ Triple Zinc

PRT15-TZ – is for 1-5/8" vertical pipe posts (1-7/8" outside pipe diameter). Can be field bent 90° for outside corner installations.

PRT2-TZ / PRT2H-TZ – is for 2" vertical pipe posts (2-3/8" outside pipe diameter). Can be field bent 90° for outside corner installations.

PRTIC2-TZ – is for inside corner installations. For 2" vertical pipe posts (2-3/8" outside pipe diameter).

Materials: See chart

Finish: G-185 galvanizing

Options: See chart for Corrosion Finish Options

Installation:

- Use all specified fasteners. See Product Notes, page 18.
- PRT15-TZ, PRT2H-TZ and PRTIC2-TZ - 1/4" Self Tapping Bolts are supplied with PRT models.
- Install self tapping bolts with 3/8" socket in predrilled holes.
- PRT2-TZ fastens with (1) 1/4" carriage bolt and nut (included) for tightening PRT2-TZ to pipe and (4) 1/4" HDG lag bolts for attaching tie to rail.
- Install 3 to 4 PRT's per pipe.
- PRT15-TZ, PRT2-TZ and PRT2H-TZ may be bent once to fit corner and angled conditions.



Typical PRT2H-TZ installation

PRT15-TZ & PRT2-TZ similar

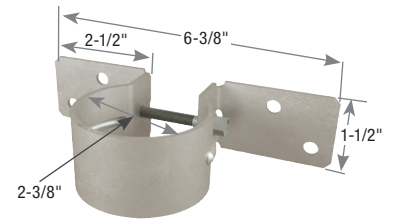

PRT2H-TZ

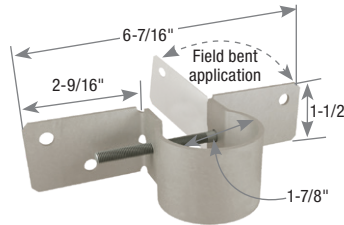

PRT15-TZ

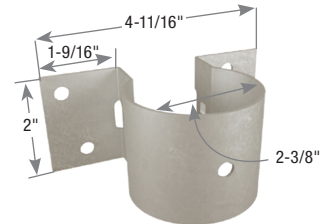

PRT2-TZ

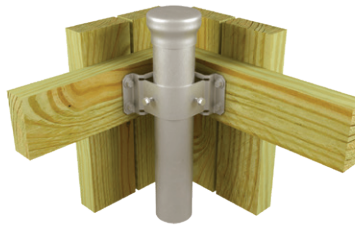

Typical PRTIC2-TZ installation

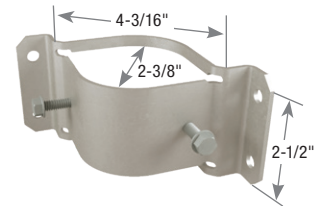

PRTIC2-TZ

MiTek Stock No.	Ref. No.	Steel Gauge	Dimensions (in)		Fastener Schedule ¹				Corrosion Finish	Code Ref.
			L	H	Pipe		Rail			
					Qty	Type	Qty	Type		
PRT15-TZ	PGT1.5Z-R	12	6-7/16	1-1/2	1	1/4" Self Tapping Bolt	4	1/4" HDG Lag Bolt		
PRT2-TZ	PGT2E	16	4-11/16	2	1	1/4" HDG Carriage Bolt	4	1/4" HDG Lag Bolt		
PRT2H-TZ	PGT2Z-R, PGT2A	12	6-3/8	1-1/2	1	1/4" Self Tapping Bolt	4	1/4" HDG Lag Bolt		--
PRTIC2-TZ	PGTIC2Z-R	12	4-3/16	2-1/2	2	1/4" Self Tapping Bolt	4	1/4" HDG Lag Bolt		

1) MiTek's WS15-EXT (1/4" dia. x 1-1/2" long) structural wood screws can be substituted for specified lag bolts.

2) Install self tapping bolts (included) with 3/8" socket in predrilled holes.

3) Install 3 to 4 PRT's per pipe.

4) PRT15, PRT2 and PRT2H Pipe Rail Ties may be bent once to fit corner and angled conditions.

Corrosion Finish Key ■ Stainless Steel ■ Gold Coat ■ HDG ■ Triple Zinc

ERB24 – Designed to mount prefabricated fence sections and works with 2x4 horizontal section rails

FB26 – Secures 2x6 rails to wood posts

FRB24 – Secures continuous 2x4 rails to wood posts. Pre-punched holes allow installers to splice 2x4 rail ends within the bracket

Materials: See chart

Finish: G-185 galvanizing

Options: See chart for Corrosion Finish Options

Installation:

- Use all specified fasteners. See Product Notes, page 18.



Typical ERB24-TZ installation

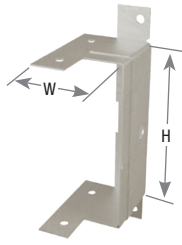

ERB24-TZ



Typical FB24-TZ installation

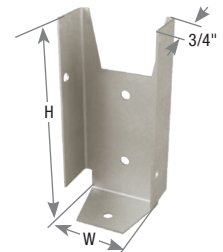

FB24-TZ



Typical FRB24-TZ installation

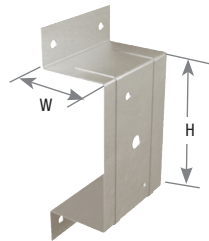

FRB24-TZ

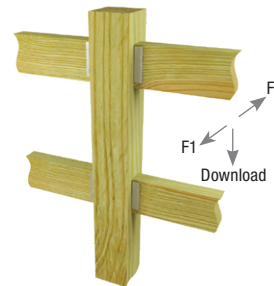

Typical FB26-TZ installation



FB26-TZ

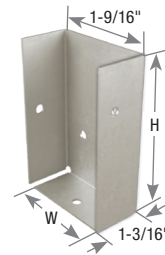

FB23-TZ



FB14-TZ

Rail Size	MiTek Stock No.	Ref. No	Steel Gauge	Dimensions (in)		Fastener Schedule ²				DF/SP Allowable Loads (Lbs) ¹				Corrosion Finish	Code Ref.
				W	H	Rail		Post		Download		F1			
						Qty	Type	Qty	Type	100%	115%	100%	115%		
1 x 4	FB14-TZ	--	18	3/4	3-1/2	3	3/4 HDG Fastener	2	8d x 1-1/2 HDG	--	--	--	--		
2 x 3	FB23-TZ	--	20	1-9/16	2-3/8	3	8d x 1-1/2 HDG	4	8d x 1-1/2 HDG	--	--	--	--		
2 x 4	ERB24-TZ	--	18	1-1/2	3-9/16	4	8d x 1-1/2 HDG	3	8d HDG	--	--	--	--		
	FB24-TZ	FB24Z, FBR24Z	20	1-9/16	3-3/8	3	8d x 1-1/2 HDG	2	8d HDG	--	--	--	--		--
	FRB24-TZ	--	18	1-9/16	3-9/16	2	10d x 1-1/2 HDG	4	10d HDG	--	--	--	--		
2 x 6	FB26-TZ	FB26	18	1-9/16	5	4	10d x 1-1/2 HDG	4	10d x 1-1/2 HDG	330	330	350	400		
						4	LL915	4	LL915	315	360	315	360		

1) Allowable loads have been increased 15% for short duration loading. No further increase is permitted.

2) **NAILS:** 8d x 1-1/2 nails are 0.131" dia. x 1-1/2" long, 8d nails are 0.131" dia. x 2-1/2" long, 10d x 1-1/2 nails are 0.148" dia. x 1-1/2" long, 10d nails are 0.148" dia. x 3" long, LL915 denotes a LumberLok screw #9 x 1-3/8" long.

New products or updated product information are designated in **blue font**.

Corrosion Finish Key ■ Stainless Steel ■ Gold Coat ■ HDG ■ Triple Zinc

PCP Plastic Post Caps

These seamless caps keep water off post tops, protecting wood from moisture damage. The PCP's plastic construction is corrosion-proof and paintable. Not available in rough or full lumber sizes.

Materials: Hi-impact plastic

Finish: Gray color

Installation:

- Fasten cap to post top with (1) 8d HDG or 10d HDG nail.

Post / Column Size ¹	MiTek Stock No.	Ref. No.	Dimension (in)	Color	Code Ref.
			W		
4 x 4	PCP44	DPPC4BK	3-5/8	Gray	--
6 x 6	PCP66	DPPC6BK	5-5/8	Gray	--

1) Not available in rough or full lumber sizes.



Typical PCP44 installation

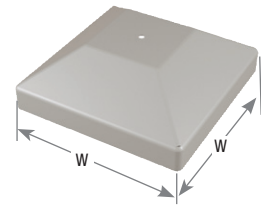

PCP66

SFP / SMP Fence Post Connectors

Take the work out of fence post installation and repair with the Speedpost, SFP30, and Speedmender, SMP. The Speedpost is used to install 4x4 fence posts without digging post holes or pouring concrete. The Speedmender plates act as reinforcement brackets for rotted or damaged 4x4 fence posts.

SFP30 – For 6' nominally-sized 4x4 fence posts.

SMP – For nominally-sized 4x4 posts.

Materials: 13 gauge

Finish: Paint

Patent: U.S. Patent No. 7,152,841

Installation:

- Step-by-step installation instructions are labeled onto each product.

Post Size	MiTek Stock No.	Ref. No.	Steel Gauge	Fastener Schedule ²		Code Ref.
				Qty	Type	
4 x 4	SFP30	FPBS44	13	3	1/4" HDG Lag Bolt	--
4 x 4	SMP ¹	FPBM44	13	20	10d HDG	--

1) Fastener schedule is per pair of SMPs.

2) **NAILS:** 10d nails are 0.148" dia. x 3" long.

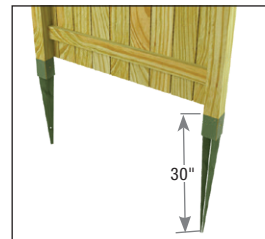

Typical SFP30 installation

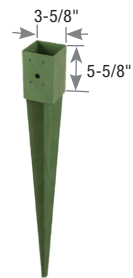

SFP30



Typical SMP installation



SMP

BD Bolt Down

Anchors 4x4 post to wood or concrete surfaces.

Materials: 13 gauge

Finish: Paint

Patents: U.S. Patent No. 7,152,841

Installation:

- Use all specified fasteners. See Product Notes, page 18.
- **Not rated for overturning resistance. Not recommended for unrestrained posts.**

Post Size	MiTek Stock No.	Ref. No.	Steel Gauge	Fastener Schedule		Code Ref.
				Qty	Type (in)	
4 x 4	BD	FPBB44	13	3	1/4 x 1-1/2 HDG Lag Bolt	--



Typical BD installation

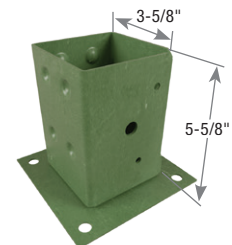

BD

GENERAL HARDWARE



GENERAL HARDWARE

308-317

Bridging	314-315
Corner Tie	316
D.I.Y. Products	309
Drywall Clip	308
Insulation Supports	308
Mending Plates	317
Nail Plates	317
Plywood Clips	308
Protection Plates	310
Shelf Brackets	316
Straps	311-312
Stud Shoes	312
Wall Bracing	313
Wall Ties	316

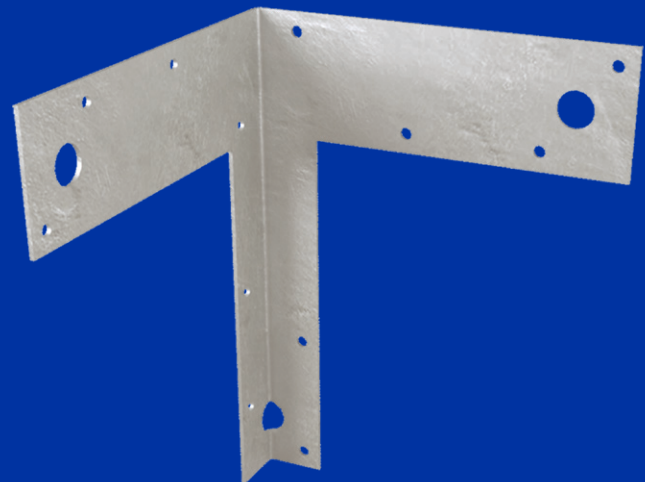

PC / RC Plywood Clips

Steel plywood clips. All models feature embossed dimples to provide 1/8" gap.

Materials: PC – 20 gauge; RC – 18 gauge

Finish: G90 galvanizing

Span Rating ¹	MiTek Stock No.	Ref. No.	Steel Gauge	Maximum Span ¹		Plywood Thickness (in)	PC's Per Span	Code Ref.
				With PC	Without PC			
24	RC38-250	PSCL3/8	18	24	20	3/8	1	--
	PC716	PSCL7/16	20	24	24	7/16	1	
32	PC1532	PSCL15/32, PSCA15/32	20	32	28	15/32	1	
	PC12	PSCL1/2	20	32	28	1/2	1	
40	PC1932	PSCL19/32	20	40	32	19/32	2	
	PC58	PSCL5/8	20	40	32	5/8	2	
48	PC34	PSCL3/4	20	48	36	3/4	2	

- 1) Based on code specified allowable spans for panel sheathing continuous over two or more spans with plywood strength axis perpendicular to supports.
- 2) Applicable to roof sheathing.
- 3) Applies to panels 24" or wider.
- 4) Uniform load deflection limitations 1/180 of span under live load plus dead load or 1/240 under live load only.

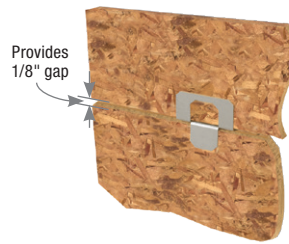

Typical PC installation



Typical RC installation



PC



RC

DC Drywall Clip

Drywall clips or "stops" help support drywall or wood paneling and reduce wood blocking on top plates, end walls, and corners.

Materials: 20 gauge

Finish: G90 galvanizing

Installation:

- Use 8d nails to install DC1, 16" on-center or less.

MiTek Stock No.	Ref. No.	Steel Gauge	Fastener Schedule ¹		Code Ref.
			Qty	Type	
DC1	DS	20	1	8d	--

1) **NAILS:** 8d nails are 0.131" dia. x 2-1/2" long.



Typical DC1 installation

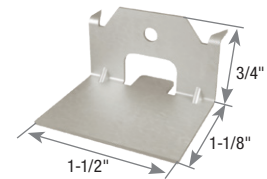

DC1

IS Insulation Supports

Insulation supports secure batt-type insulation in place between joists. Chisel-cut ends dig into joists for permanent holding. Easy to install in hard-to-reach crawl spaces.

Materials: 13 gauge carbon steel wire

Finish: None

Installation:

- Use IS16 for joist spaced 16" O.C. and IS24 for 24" O.C. spacing.
- Position insulation batt in place between joists. Hold IS unit at the center and push into place.
- Wear gloves and safety glasses during installation.

MiTek Stock No.	Ref. No.	Steel Gauge	Joist Spacing	Dimensions (in)	Code Ref.
				Overall Length	
IS16	IS16-R100	13	16" O.C.	15-1/2"	--
IS24	IS24-R100	13	24" O.C.	23-1/2"	--

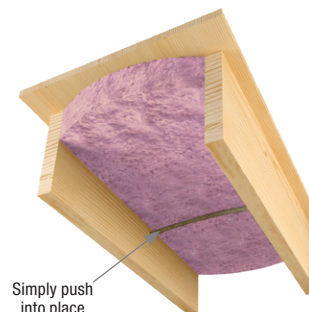

Simply push into place

Typical IS installation

Connectors for homeowner / D.I.Y. Projects.

TTA12-TZ – an angle connects two 1x wood members at 90° angles.

TTA2-TZ – an angle connects two 2x wood members at 90° angles..

TTC42-TZ – a corner tie connects 2x wood members at 90° to the corner of a 4x4 post.

TTF22-TZ – a bracket connects 2x wood members to opposite sides of a 2x4 or 4x4 post.

TTR-TZ – a clip connects a 2x wood member to the face of another wood member.

TTU2-TZ – a U-clip connects 2x wood members crossing at 90°.

Materials: See chart

Finish: G-185 galvanizing

Options: See chart for Corrosion Finish Options

Installation:

- Use all specified fasteners. See Product Notes, page 18.
- MiTek LumberLok LL915 (#9 x 1-3/8" long) wood screws are not supplied with connectors.

MiTek Stock No.	Ref. No.	Steel Gauge	Post Size	Joist Size	Fastener Schedule ¹				DF/SP Allowable Loads (Lbs.) ^{2,3}				Corrosion Finish	Code Ref.
					Post		Joist (Total)		Download 100%	Uplift 100%	F1 100%	F2 100%		
					Qty	Type	Qty	Type						
TTA12-TZ	RTA12	18	1x	1x	4	LL915	4	LL915	--	205	190	205		
TTA2-TZ	RTA2Z	16	2x	2x	4	LL915	4	LL915	--	185	255	185		
TTU2-TZ	RTU2	18	2x	2x	2	LL915	4	LL915	--	--	210	210		
TTR-TZ	RTR	20	2x	2x	2	LL915	4	LL915	210	210	210	155		--
TTF22-TZ	RTF2Z	18	2 x 4	2x	4	LL915	8	LL915	420	265	--	--		
TTC42-TZ	RTC42, RTC42Z	18	4 x 4	2x	14	LL915	8	LL915	735	420	--	--		

1) LL915 denotes a LumberLok Screw, #9 x 1-3/8" long.
 2) TTF22-TZ: Allowable loads must be equally distributed on both joists.
 3) TTC42-TZ: Allowable loads listed in this table are for each joist being carried by the post.

Corrosion Finish Key ■ Stainless Steel ■ Gold Coat ■ HDG ■ Triple Zinc

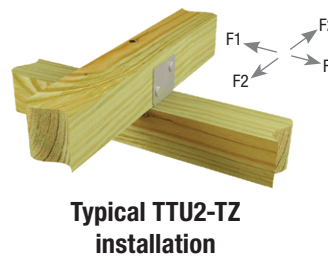
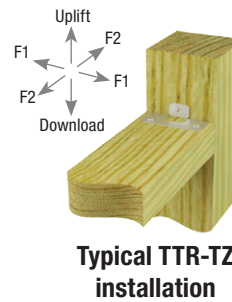
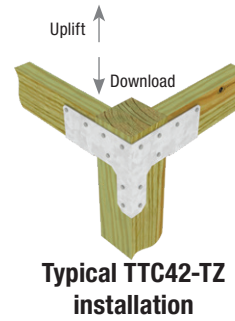
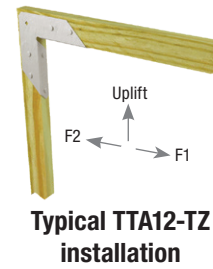

Easy-to-install plates protect plumbing and power/communication wiring from nail or screw penetration. 16 gauge steel conforms to protection shield plate requirements of the National Electrical Code and International Plumbing Code.

ICPL58 – Installs with nails.

KNS1 / PL4 – Prongs allow for quick installation.

Materials: 16 gauge

Finish: ICPL516-TZ – G-185 galvanizing;

All others – G90 galvanizing

Options: See chart for Corrosion Finish Options

Codes: IRC P2603.2.1 & R602.6.1, IBC 2308.5.8, IPC 305.6

Installation:

- Use all specified fasteners. See Product Notes, page 18.

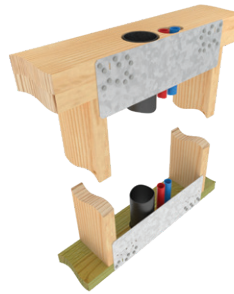

Typical ICPL516-TZ installation

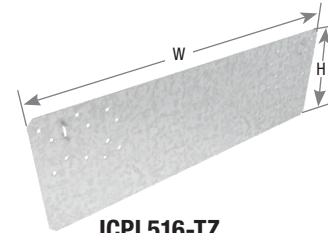

ICPL516-TZ



Typical ICPL58 installation

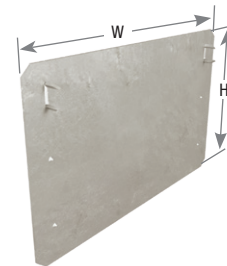

ICPL58

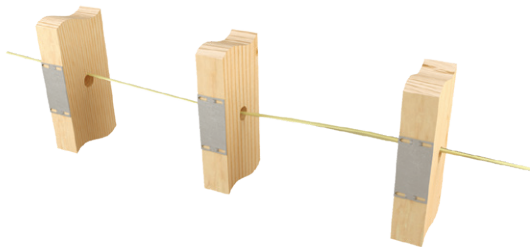

Typical KNS1 / PL4 installation



KNS1



PL4

MiTek Stock No.	Ref. No.	Steel Gauge	Dimensions (in)		Installation Type	Fastener Schedule ²		DF/SP Allowable Loads (Lbs.) ¹	S-P-F Allowable Loads (Lbs.) ¹	Corrosion Finish	Code Ref.
			W	H		Qty	Type				
ICPL58	--	16	8-1/16	5	--	4	8d or prongs	--	--		PC
PL4	NS2	16	2	5	--	--	prongs	--	--		
KNS1	NS1	16	1-1/2	3	--	--	prongs	--	--		
ICPL516-TZ	PSPN516Z	16	16-1/4	5	Sill Plate	12	16d HDG + prongs	1355	1160		
					Double Top Plate	16	16d HDG + prongs	1805	1550		

1) Allowable loads have been increased 60% for wind or seismic loads; no further increase shall be permitted.

2) **NAILS:** 8d nails are 0.131" dia. x 2-1/2" long, 16d nails are 0.162" dia. x 3-1/2" long.

Corrosion Finish Key ■ Stainless Steel ■ Gold Coat ■ HDG ■ Triple Zinc

The HFS Hardy Frame® Saddle is a 14 gauge steel channel intended to be used as a splice at locations where plumbing or other vertical penetrations destroy the structural integrity of a wall's top plates.

Materials: 14 gauge
Finish: G60 galvanizing
Codes: IBC, FL, LA

Installation:

- Use all specified fasteners. See Product Notes, page 18.
- The Saddle can be installed over the top or from the underside of the top plates, and is capable of resisting both tension and compression loads in a clearspan of up to 4-1/2".
- For wall depths greater than 3-1/2", or to install after plumbing lines have been run, the product can be separated into two "L" shapes by gripping the legs of the channel and flexing the top surface along the serration lines.

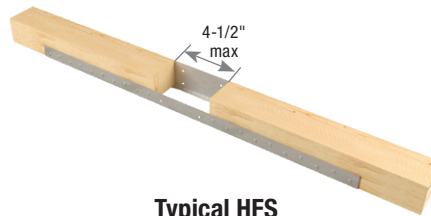

Typical HFS installation to underside of double top plates.

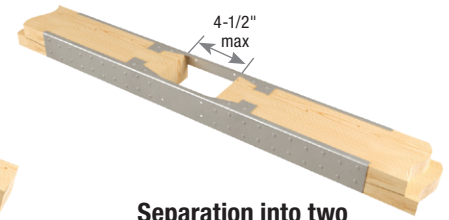

Separation into two "L" shapes at 6" and greater depths

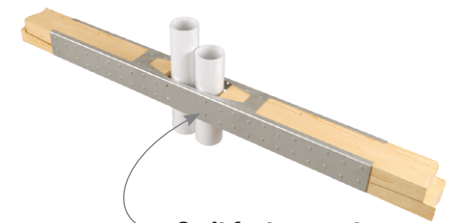

Omit fasteners at first holes when the end distance is less than 1"

MiTek Stock No.	Ref. No.	Steel Gauge	Dimensions (in)		Notch Width	Fastener Schedule		DF/SP Allowable Loads (Lbs.) ^{1,3}		S-P-F Allowable Loads (Lbs.) ^{1,3}		Code Ref.
			W	L		Qty ²	Type ⁴	Tension 100%	Compression 100%	Tension 100%	Compression 100%	
HFS24	--	14	3-5/8	24	≤ 4-1/2	24	16d	2950	2500	2537	2500	IBC, FL, LA
HFS36	--	14	3-5/8	36	≤ 4-1/2	32	16d	4280	2500	3681	2500	

- 1) Allowable tension loads are for normal duration. The values may be adjusted for other durations, such as for seismic and wind loading in accordance with the NDS.
- 2) Fastener quantity is the number of 16d common nails to be installed into each of the members to be joined. When the end distance from the joint to the first nail hole is less than 1", omit the (2) nails in the 3" side-plate and the (1) nail in the 1-1/2" side-plate that are nearest the joint.
- 3) There is no reduction in double top plate capacity provided the HFS24 is installed with minimum (22) 16d common nails in each member being joined (44 total) and the HFS36 is installed with (31) 16d common nails in each member (62 total).
- 4) **NAILS:** 16d nails are 0.162" dia. x 3-1/2" long.

KRPS repair straps meet IBC, IRC, & L.A. City requirements for notched plates where placed in partitions.

Materials: See chart

Finish: G90 galvanizing

Options: See chart for Corrosion Finish Options

Codes: See chart for code references

IRC R602.6.1, IBC 2308.5.8

Installation:

- Use all specified fasteners. See Product Notes, page 18.
- Install one strap tie for each 2x plate.



Typical KRPS installation

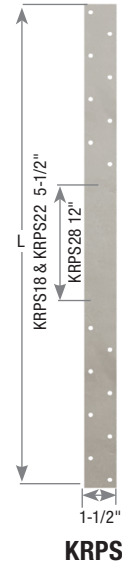

MiTek Stock No. ³	Ref. No.	Steel Gauge	Dimensions (in)		Notch Width (in)	Fastener Schedule ²		DF/SP Allowable Loads (Lbs.) ¹ Tension 160%	Corrosion Finish	Code Ref.
			W	L		Qty	Type			
KRPS18	RPS18	16	1-1/2	18-5/16	≤ 5-1/2	12	16d	1345		IBC, FL, LA
KRPS22	RPS22	16	1-1/2	22-5/16	≤ 5-1/2	12	16d	1345	Green	IBC, FL
						16		1790		IBC, FL, LA
KRPS28	RPS28	16	1-1/2	28-5/16	≤ 12	12	16d	1345	Green	IBC, FL
						16		1790		IBC, FL, LA

1) Allowable loads have been increased 60% for wind or seismic loads; no further increase shall be permitted.

2) **NAILS:** 16d nails are 0.162" dia. x 3-1/2" long.

Corrosion Finish Key ■ Stainless Steel ■ Gold Coat ■ HDG ■ Triple Zinc

STS Stud Shoes

Stud shoes reinforce joists, plates, studs, or rafters which have been drilled or notched during construction.

Materials: 18 gauge

Finish: G90 galvanizing

Installation:

- Use all specified fasteners. See Product Notes, page 18.
- **STS units are not structurally rated and should not be used as a total member replacement in structural applications.**
- For use with 2" O.D. pipe.



Typical STS1 installation

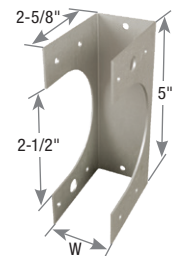

STS

MiTek Stock No.	Ref. No.	Steel Gauge	Description	Dimension (in)		Fastener Schedule ^{1,2}	
				W	Qty	Type	
STS1	--	18	Single Stud	1-9/16	10	10d x 1-1/2	
STS2	--	18	Double Stud	3-1/16	12	10d	
STS3	--	18	Triple Stud	4-9/16	14	10d	

1) Maximum hole size = 2".

2) **NAILS:** 10d x 1-1/2 nails are 0.148" dia. x 1-1/2" long, 10d nails are 0.148" dia. x 3" long.

RWB / WB / WBC / WBT Wall Bracing

Wall bracing products are engineered to meet the prescriptive 1x4 let-in brace code requirements.

RWB – Flat bracing conveniently packaged in a handy roll out dispenser. Perfect for unexpected job site shortages. The 35-pound dispenser pack fits easily into a truck bed for transport. Pre-embossed snap-off points can be broken off by hand (wear gloves for safety).

WB – A flat style bracing engineered to easily nail to studs. No cutting or fitting needed.

WBC – L-shaped design for additional strength and rigidity.

WBT – Rolled edges and T-style design gives the WBT strength, rigidity, and eliminates sharp, sheared edges.

Materials: See chart

Finish: G90 galvanizing

Codes: IBC, FL, LA
IRC R602.10.4 & Table 602.10.4, IBC 2308.6.3 & Table 2308.6.3(1)

Installation:

- Use all specified fasteners. See Product Notes, page 18.
- Bracing is a framing aid, not a substitute for structural shear wall components.
- **RWB / WB** – Use with 16" or 24" o.c. studs. Install in pairs forming an "X" or opposing "V" at each end of a maximum 25-foot long wall panel.

Steps: Square the panel. Straighten any kinks in bracing caused by handling. Lay bracing on the panel flush to the top of top plate and flush to the bottom of the bottom plate. Secure bracing to the top plate and bottom plate using 16d nails (WB) or 8d nails (RWB). Position second bracing at an angle opposite to the first brace to form an "X" and secure to top and bottom plate as with the first bracing. Using 8d nails, secure bracing to all intersecting studs.

- **WBC / WBT** – Use with 16" or 12" o.c. studs. Install one brace at each end of wall section, not exceeding 25 feet, in an opposing "V" pattern. Use the web portion of a length of bracing as a straight edge to mark studs. Cut a saw kerf 5/8" deep (1" deep for WBC). Insert the bracing web into the saw kerf, and drive one nail into the top plate. Raise the wall section into place and plumb. Finish fastening according to the nail schedule.



RWB pre-embossed snap-off points



Typical RWB/WB installation

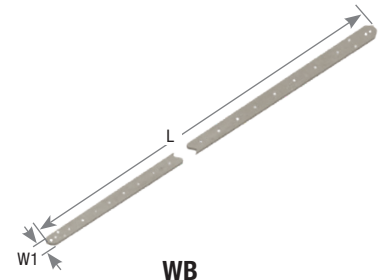

WB



Typical WBC/WBT installation

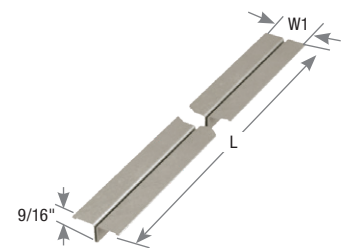

WBT

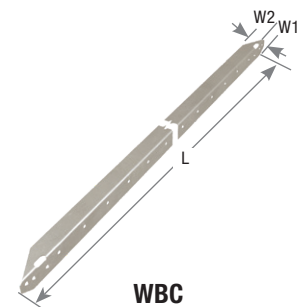

WBC

MiTek Stock No. ¹	Ref. No.	Steel Gauge	Dimensions (in)			Pieces Per Roll	Wall Height (ft)	Install Angle	Fastener Schedule ²				Code Ref.
			W1	W2	L				Each Plate		Each Stud		
									Qty	Type	Qty	Type	
RWB96	WB106C	16	1-1/4	--	9' 6"	15	8'	60°	4	8d	1	8d	IBC, FL, LA
RWB114	WB126C	16	1-1/4	--	11' 4-3/8"	12	8'	45°	4	8d	1	8d	
RWB143	WB143C	16	1-1/4	--	14' 3"	10	10'	45°	4	8d	1	8d	
WBC10	RCWB10	18	7/8	1	9' 5-5/8"	--	8'	60°	2	16d	1	8d	
WBC12	RCWB12	18	7/8	1	11' 4-3/8"	--	8'	45°	2	16d	1	8d	
WBT10	TWB10	22	1-3/8	--	9' 3"	--	8'	60°	4	8d	1	8d	
WBT12	TWB12	22	1-3/8	--	11' 4"	--	8'	45°	4	8d	1	8d	
WBT14	RCWB14, TWB14	22	1-3/8	--	14' 2"	--	10'	45°	4	8d	1	8d	
WB106	WB106	16	1-1/4	--	9' 5-1/2"	--	8'	60°	3	16d	1	8d	
WB126	WB126	16	1-1/4	--	11' 4-1/4"	--	8'	45°	3	16d	1	8d	

1) These products substitute for code prescribed 1 x 4 let-in bracing.

2) **NAILS:** 8d nails are 0.131" dia. x 2-1/2" long, 16d nails are 0.162" dia. x 3-1/2" long.

O – The O series spans three joists in under/over installation. Prong teeth in the center help reduce nailing.

N – The N series spans two joists per unit. Can be used for bridging or bracing I-Joists. See chart.

Materials: See chart

Finish: G90 galvanizing

Codes: IBC, FL, LA

Installation:

- Use specified fasteners in models with fastener requirements.
- For all models – Bridging should be installed on floor joists with a nominal depth-to-thickness ratio of 5 to 6 or more (2018 National Design Specification for Wood Construction; Section 4.4.1). Bridging units should be installed in pairs at intervals of 8' or less. Bridging pairs should form an "X" between joists; leave a slight space between the units to avoid noise-generating contact. Follow specific installation instructions below for particular models.
- Install prior to subfloor sheathing. Use (2) 8d (0.131") x 1-1/2" nails at each end. Fully seat nails to avoid any movement against the bridging and subsequent floor noise.
- Must be installed in cross pairs. Avoid bridging overlap, it may cause squeaks



Typical O installation

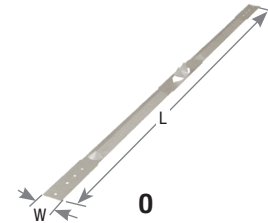

Typical N installation

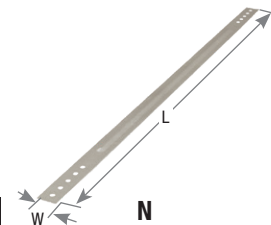

MiTek Stock No.	Ref. No.	Steel Gauge	Dimensions (in)		Fastener Schedule ¹		Code Ref.
			W	L	Qty	Type	
N16	LTB20, TB20	22	3/4	19-3/4	4	8d x 1-1/2	IBC, FL, LA
O40	LTB40	22	3/4	39-3/4	4	8d x 1-1/2	
N27	TB27	20	3/4	26-13/16	4	8d x 1-1/2	
N30	TB30	20	3/4	29-13/16	4	8d x 1-1/2	
N36	TB36	20	3/4	35-13/16	4	8d x 1-1/2	
N42	TB42	20	3/4	42	4	8d x 1-1/2	
N48	TB48	20	3/4	48	4	8d x 1-1/2	
N54	TB54	20	3/4	54	4	8d x 1-1/2	
N56	TB56	20	1	56	4	8d x 1-1/2	
N60	TB60	20	1	60	4	8d x 1-1/2	

1) For joist spacing, refer to the Joist Installation chart.

2) **NAILS:** 8d x 1-1/2 nails are 0.131" dia. x 1-1/2" long.

Joist Installations

Joist Type	Joist Height	Joist Spacing ¹								
		12"	16"	19.2"	24"	30"	32"	36"	42"	48"
2x Sawn Dimensional	7-1/4	--	O40/N16	N27	N27/N30	N36	N36	N42	N48	N54/N56
	9-1/4	N16	O40/N16	N27	N30	N36	N36	N42	N48	N54/N56
	9-1/2	O40/N16	O40	N27	N30	N36	N36	N42	N48	N54/N56
1-3/4" SCL	10	N16	N16	N27	N30	N36	N36	N42	N48	N54/N56
	11-1/4	N16	N16	N27	N30	N36	N36	N42	N48	N54/N56
	11-7/8	N16	N27	N27/N30	N30	N36	N36	N42	N48	N54/N56
I-Joists: 2-1/2" & 3-1/2" wide	12	N27	N27	N27/N30	N30	N36	N42	N42	N48	N54/N56
	14	N16	N16	N16	N27/N30	N36	N36	N36	N42	N56
	16	N16	N16	N27	N30	N36	N36	N42	N48	N56
	18	N16	N16	N27	N30	N36	N36	N42	N48	N54/N56
	20	N16	N27	N27/N30	N30	N36	N36	N42	N48	N54/N56
	22	N27	N27	N30	N30	N36	N36	N42	N48	N54/N56
	24	N27	N30	N30	N36	N36	N42	N42	N48	N54/N56
	26	N30	N30	N30	N36	N42	N42	N42	N48	N54/N56/N60
28	N30	N30	N36	N36	N42	N42	N48	N48	N56/N60	

1) Gray shaded cells represent bridging installed on the face of the joist; web stiffeners required for I-Joists.

2) All bridging products require (2) 8d x 1-1/2 nails at each end, which are 0.131" dia. x 1-1/2" long.

MBG – Grip tooth bridging. Features special teeth which grip joists and provide easy single-nail installation. Can be installed after subfloor is in place.

MB16 – Snap-on, no-nail bridging can be placed in existing floor systems where joist movement is suspected. Two-piece construction creates a solid diagonal brace against joist movement.

Materials: See chart
Finish: G90 galvanizing
Codes: IBC, FL, LA

Installation:

- Use specified fasteners in models with fastener requirements.
- For all models – Bridging should be installed on floor joists with a nominal depth-to-thickness ratio of 5 to 6 or more (2018 National Design Specification for Wood Construction; Section 4.4.1). Bridging units should be installed in pairs at intervals of 8' or less. Bridging pairs should form an "X" between joists; leave a slight space between the units to avoid noise-generating contact. Follow specific installation instructions below for particular models.
- **MBG** – May be installed before or after sheathing. Position the unbent end of the bridging unit near the top of the joist and drive prongs into wood with a hammer blow to the heel of the bent end. Wedge bent end near the lower edge of the opposite joist, set teeth into wood with hammer blow. Nail holes are provided at the bent end if prongs are damaged during installation. Fully seat nails to avoid any movement against the bridging and subsequent floor noise.
- **MB16** – Two-piece unit is shipped as one piece. Bend unit in center up and down to break into two pieces. Slide narrower piece inside wider piece, setting the end tab into slot appropriate for joist spacing. Setting one prong end near the top of one joist and the opposite prong end near the bottom of the opposite joist, pull down on the center of the bridging until the wider piece snaps into place over the narrow piece and creates a rigid, one-piece bridging unit. Wear gloves during installation.



MB16



Typical MB16 installation

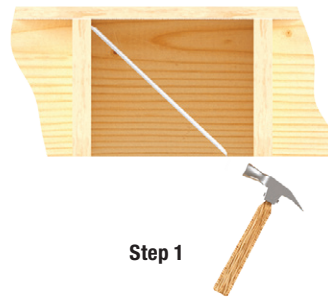

Step 1



Step 2

Typical MBG installation

Joist Size	Joist Spacing O.C. (in) ¹	MiTek Stock No.	Ref. No.	Steel Gauge	Dimensions (in)		Fastener Schedule ²		Code Ref.
					W	L	Qty	Type	
2 x 8	12	MBG812	NCA2X8-12	22	15/16	11-3/4	1	8d x 1-1/2	IBC, FL, LA
2 x 10	12	MBG1012	NCA2X10-12	22	15/16	12-3/4	1	8d x 1-1/2	
2 x 12	12	MBG1212	NCA2X12-12	22	15/16	14	1	8d x 1-1/2	
2 x 14	12	MBG1412	--	22	15/16	16	1	8d x 1-1/2	
2 x 16	12	MBG1612	--	22	15/16	17	1	8d x 1-1/2	
2 x 8-10-12	16	MB16	--	22	11/16	--	--	--	
2 x 8	16	MBG816	NCA2X8-16	22	15/16	15-9/16	1	8d x 1-1/2	
2 x 10	16	MBG1016	NCA2X10-16	22	15/16	16-5/16	1	8d x 1-1/2	
2 x 12	16	MBG1216	NCA2X12-16	22	15/16	17-1/4	1	8d x 1-1/2	
2 x 14	16	MBG1416	--	22	15/16	18-7/16	1	8d x 1-1/2	
2 x 16	16	MBG1616	--	22	15/16	19-5/8	1	8d x 1-1/2	
2 x 8	24	MBG824	--	22	1-5/16	23-1/2	1	8d x 1-1/2	
2 x 10	24	MBG1024	--	22	1-5/16	24	1	8d x 1-1/2	
2 x 12	24	MBG1224	--	22	1-5/16	24-3/4	1	8d x 1-1/2	
2 x 14	24	MBG1424	--	22	1-5/16	25-5/8	1	8d x 1-1/2	
2 x 16	24	MBG1624	--	22	15/16	26-5/8	1	8d x 1-1/2	



MBG

Copyright © 2022 MiTek Industries, Inc. All Rights Reserved

1) Joist spacing is based on a 1-1/2" joist, consult MiTek regarding wider joist applications.
 2) **NAILS:** 8d x 1-1/2 nails are 0.131" dia. x 1-1/2" long.

SB Shelf Brackets

General Hardware

This shelf bracket combines shelving capabilities and closet rod support in a one-piece design.

Materials: 13 gauge

Finish: Zinc Plated



Typical SB12 installation

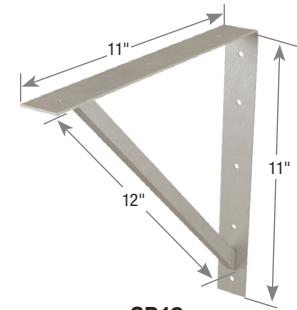

SB12

MiTek Stock No.	Ref. No.	Steel Gauge	Fastener Schedule ¹		Code Ref.
			Qty	Type	
SB12	SBV	13	8	10d	--

1) **NAILS:** 10d nails are 0.148" dia. x 3" long.

KSCT Corner Tie

The Corner Tie secures three-way wood-to-wood connections. Handy for building workbenches, utility tables, or shelving using 2x4 lumber.

Materials: 14 gauge

Finish: G90 galvanizing

Installation:

- Use (12) #10 panhead screws to fasten the KSCT68 to wood framing.



Typical KSCT68 installation

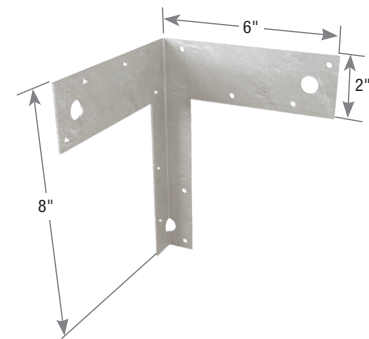

KSCT68

MiTek Stock No.	Ref. No.	Steel Gauge	Fastener Schedule		Code Ref.
			Qty	Screws	
KSCT68	--	14	12	#10 panhead	--

WT Wall Tie

Materials: 22 gauge

Finish: G90 galvanizing

Options: See chart for Corrosion Finish Options

Installation:

- Use nails appropriate for intended use. See Product Notes, page 18.
- The opposite end must be bonded in the mortar joint of brick facade.
- Check local codes for spacing requirements.
- Wall tie shall be bent at nail, bonding into mortar joint.

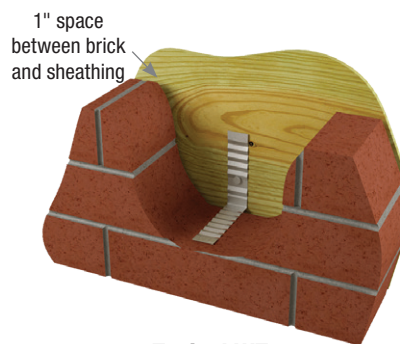

Typical WT22 installation



WT22

MiTek Stock No.	Ref. No.	Description	Steel Gauge	Dimensions (in)		Fastener Schedule ¹		Corrosion Finish	Code Ref.
				W	L	Qty	Type		
WT22	BTB	Straight Edge - Duplex	22	7/8	6-1/2	1	10d		--

1) **NAILS:** 10d nails are 0.148" dia. x 3" long.

Corrosion Finish Key ■ Stainless Steel ■ Gold Coat ■ HDG ■ Triple Zinc

NP Nail Plates

The NP Nail Plates are an ideal economical solution for attaching wooden members together in a non-structural connection. Also may be used as a prescriptive top plate splice per the International Residential Code (IRC). They are pre-punched for 8d common nails.

Materials: 20 gauge
Finish: G90 galvanizing
Codes: IRC R602.3.2

Installation:

- Use nails appropriate for intended use. Holes are sized for 8d common (0.131" dia. x 2-1/2" long) or 8d (0.131" dia.) x 1-1/2" nails.
- The designer shall determine appropriate load values.

MiTek Stock No.	Ref. No.	Steel Gauge	Dimensions (in)		Number of Nail Holes	Code Ref.
			W	L		
NP15	TP15	20	1-13/16	5	12	--
NP35	TP35	20	3-1/8	5	22	
NP37	TP37	20	3-1/8	7	31	
NP39	TP39	20	3-1/8	9	40	
NP311	TP311	20	3-1/8	11	49	
NP312	TP312	20	3-1/8	12	54	
NP315	TP316	20	3-1/8	15	67	
NP45	TP45	20	4-1/8	5	30	
NP47	TP47	20	4-1/8	7	42	
NP49	TP49	20	4-1/8	9	54	
NP411	TP411	20	4-1/8	11	66	
NP57	TP57	20	5-3/4	7	59	

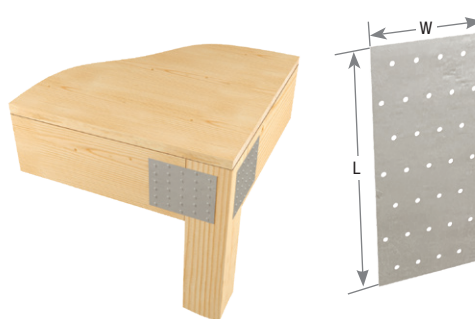

Typical nail plate installation

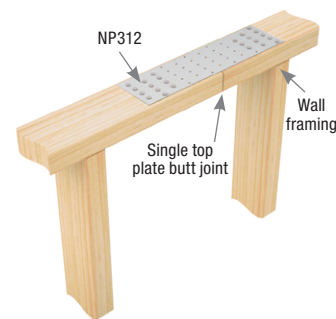

Typical NP312 prescriptive top plate splice installation

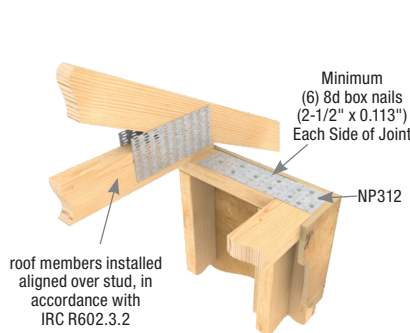

Typical NP312 prescriptive top-plate wall corner connection

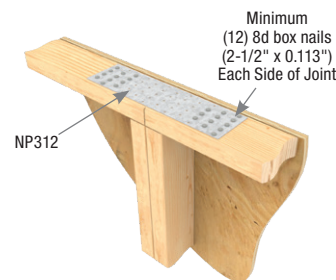

Typical NP312 prescriptive top-plate butt joint straight wall connection

JNP / TPP Mending Plates

TPP – Prong plates with straight prongs.

JNP – Prong plates with angled, hammer-in prongs.

Materials: See chart
Finish: G90 galvanizing

Installation:

- **These products are not intended for structural use. No load ratings are assigned. These plates are not intended for use in truss assembly.**

MiTek Stock No.	Ref. No.	Steel Gauge	Dimensions (in)		Code Ref.
			W	L	
JNP24	--	18	1-1/2	4	--
JNP26	--	18	1-1/2	6	
JNP46	--	18	3-3/16	6	
JNP48	--	18	3-3/16	8	
TPP14	MP14	22	13/16	3-1/2	
TPP24	MP24	22	1-11/16	3-1/2	
TPP36	MP36	22	2-3/4	5-1/4	
TPP58	--	22	4-3/16	7-13/16	



Typical mending plate installation

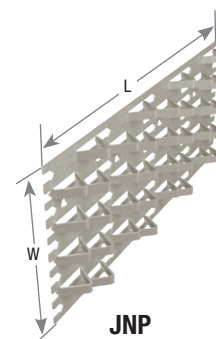

JNP

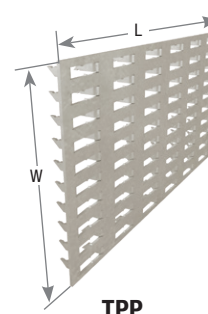

TPP

SPECIALTY OPTIONS



SPECIALTY OPTIONS

320-325

Face Mount Hanger	321
Open Top Flange Hanger	322
Part Number System	325
Solid Top Flange Hanger	322-323
Specialty Options & General Notes	320
Top Flange Nailer Options	323-324
Welded Top Flange Hanger	325



The information listed only applies to hangers manufactured by MiTek® and installed according to the instructions listed in this catalog. Some of the options listed may not have been evaluated on a single hanger. The designer must always evaluate each connection, including the joist and header capacities, before specifying a specialty connector. MiTek sloped hangers are manufactured with the plumb cut of the joist already calculated. If a hanger with a different height is needed, it must be specified at the time of ordering.

Materials: Steel gauge may vary from that specified depending on the specialty option and manufacturing process used. Some formed hangers may be welded when modifying the hanger. Hanger configurations, fastener schedules, and height may vary from the tables depending on the joist size, skew, and slope.

Finish: See specific hanger option tables. Welded hangers are painted with gray primer. Non-catalog hangers available in Hot-dip galvanized, use HDG after product number.

Allowable Loads: For multiple options for the same connector, use the most conservative reduction to give the lowest design load. See specific hanger option tables for applicable load reductions and maximum tolerances. Reference Specialty Options Summary Table for MiTek series catalog page references.

Installation:

- Fill all nail holes with fasteners specified in the tables.
- Fastener quantities may increase from the amount listed in the tables depending on hanger option.
- NA16D-RS and NA20D nails are supplied with hangers.
- For bevel cut skewed hangers, the end of joist must be bevel cut; for square cut skewed hangers, the end of joist must be square cut.

Codes: Modified hangers are not code evaluated due to their numerous variations.

Specialty Options Summary Table

MiTek Series	Width	Skewed (Maximum)	Sloped Seat (Maximum)	Sloped / Skewed	Sloped Top Flange (Maximum)	Top Flange Offset	Saddle Hanger	Ridge Hanger (Maximum)	Inverted Flange	Uplift	Weatherability	MiTek Series Catalog Page Reference
BPH	all	50°	45°	•	45°					•	•	218
FWH	all	70°				•					•	194
FWH/S	all	70°				•						337
FWHBP	all	70°									•	196
FWHFM	all	70°									•	200
FWHH	all	70°									•	198
GHF	all	50°	45°	•					• width > 4-1/2"	•		233
HBPH	all	50°	45°	•	45°					•	•	218
HD ^{1,2}	1-3/4" or less	67-1/2°	45°	•					• width > 2-1/4"	•		208
	> 1-3/4"	50°										
HDO	1-3/4" or less	67-1/2°	45°	•					• width > 3-1/8"	•		167
	> 1-3/4"	50°										
HGU	all	45°							• one flange width > 5-1/4"	•		232
HGUM	all								• one flange			187
HJC	all	60°								•		281
HLBH	all	50°	45°	•	45°	•	•	45°			•	219
HUS	all								• width > 2-1/4"	•		140
HWUH	all	45°	45°	•		•	•			•		190
IHFL/IHF	1-3/4" or less	67-1/2°	45°	•					• width > 2-1/4"	•		206
	> 1-3/4"	50°										
KB	all									•	•	166
KEG	all	45°	45°							•		235
KGB	all									•	•	236
KGH	all	45°						•				63
KGLS	all	50°	45°	•	30°	•	•			•	•	238
KGLST	all							•		•	•	238
KGLT	all	50°	45°	•	45°	•	•			•	•	237
KHGB	all									•	•	236
KHGLS	all	50°	45°		30°	•	•			•	•	238
KHGLST	all							•		•	•	238
KHGLT	all	50°	45°	•	45°	•	•			•	•	237
KHHB	all									•	•	236
KHW	all	84°	45°	•	35°	•	•	45°			•	168
KLB	all										•	166
KLEG	all	45°	45°			•				•		235
KMEG	all	45°	45°			•				•		235
LGU	all	45°							• one flange width > 3-5/8"	•		232
LGUM	all								• one flange			187
LSSH	all	45°	45°	•						•		174
MGU	all	45°							• one flange width > 5-1/4"	•		232
MPH ¹	all	60°	45°	•		•						188
MSHA	all	75°								•		278
MSHL/R	all	45°								•		276
NFM	all	45°								•		192
PHM	all	84°	45°	•	35°	•	•	45°			•	220
PHXU ¹	all	60°	45°	•	35°	•	•			•	•	220
SKH/SKHH	all	45°								•		175
SUH	1-3/4" or less	67-1/2°	45°	•						•		139
	> 1-3/4"	50°										
SW ¹ /SWH ¹	all	84°	45°	•	35°	•	•	45°			•	168
THD	all	45°	45°	•					• one flange width > 3"	•		269
THDH	all	45°	45°	•						•		270
THDQ	all	45°	45°	•					• two flange width ≥ 6-9/16"	•		272
THF	> 1-3/4"	50°	45°	•					• width > 2-1/4"	•		207

1) Skews greater than 45° will have square cut joist with back plate. Refer to Typical HLBH hanger skewed, left shown, square cut illustration on page 322.
 2) HD hanger widths less than 2-1/4" may have flanges inverted as a Custom, contact MiTek.
 New products or updated product information are designated in blue font.

Face Mount Hanger Specialty Details

Specialty Options

See the Specialty Options Chart for each hanger series for load reductions and hanger maximum range of skew, slope, etc.

Skewed Hanger:

- Consider SKH or SKHH hangers for 45° skews.
- Joist nails on the closed side may be relocated to the open side by MiTek designer to ensure proper nailing.
- Specify skew angle, type (square cut or bevel cut), and direction when ordering.

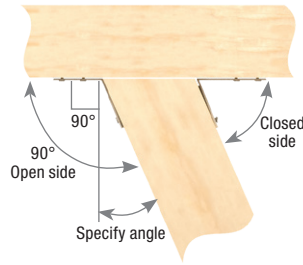

Typical SUH hanger skewed, right shown (bevel cut)

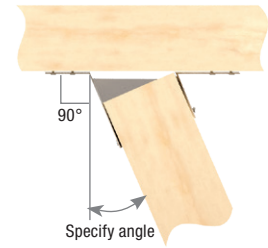

Typical SUH formed hanger skewed, right shown (square cut)

Sloped Seat Hanger:

- Consider LSSH series for sloped applications.
- Additional nail holes may be added to joist flanges by MiTek designer.
- Specify slope angle and direction when ordering.

Sloped/Skewed Hanger:

- See nailing notes above for both Skewed Hanger and Sloped Seat Hanger.
- Specify skew and slope angles as well as skew/slope directions and skew type (square cut or bevel cut) when ordering.

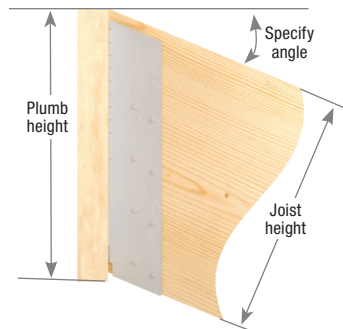

Typical HD hanger sloped seat, down shown

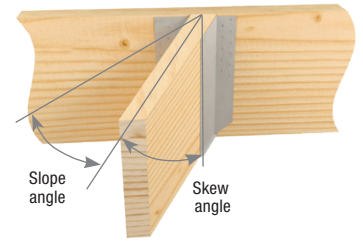

Typical HD hanger sloped down, skewed left shown

Inverted Flange Hanger:

- When fastening into the carrying member's end grain, the allowable load is 0.65 of the table load.
- Hangers with one flange inverted achieve 100% of listed table load.
- Specify right or left flange when inverting only one flange.

Refer to GHF, HD, SUH, THD, THDH, THF series Special Order Worksheet for ordering instructions at MiTek-US.com.



Typical GHF hanger one flange inverted, left shown



Typical HD hanger inverted flange

Open Top Flange Hanger Specialty Details

Specialty Options

See Specialty Options Chart for each hanger series for load reductions and hanger maximum range of skew, slope, etc.

Skewed Hanger:

- Joist nails may be located on obtuse angle side by MiTek designer to ensure proper nailing.
- Specify skew angle, type (square cut or bevel cut), and direction when ordering.

Sloped Seat Hanger:

- Additional nail holes may be added to joist flanges by MiTek designer. All fastener holes must be filled.
- Specify slope angle, direction, and joist height when ordering.

Sloped/Skewed Hanger:

- See nailing notes above for both Skewed Hanger and Sloped Seat Hanger.
- Specify skew and slope angles as well as skew/slope directions, and skew type (square cut or bevel cut) when ordering.
- Similar to face mount skewed/sloped hanger, refer to illustration on page 321: Typical HD hanger sloped down, skewed left shown.
- Specify if hanger is to be high side flush, low side flush, or center flush.

Sloped/Skewed/Sloped Top Flange Hanger:

- See nailing notes for both skewed and sloped hangers.
- Specify skew, slope, and top flange slope angles as well as skew/slope and top flange slope directions when ordering.
- Hangers may be galvanized or painted.
- Hangers may be made with solid top plate.

Refer to BPH series Special Order Worksheet for ordering instructions at MiTek-US.com.

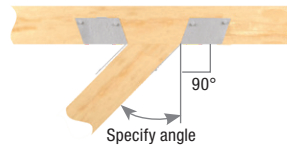

Typical BPH hanger skewed, left shown
(bevel cut)

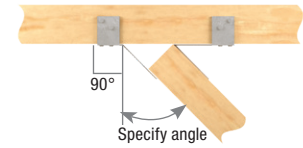

Typical HDO hanger skewed, right shown
(square cut)

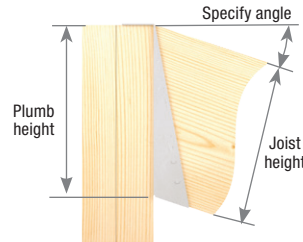

Typical BPH hanger sloped seat, down shown

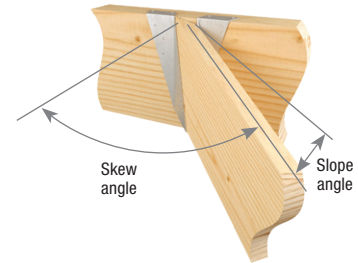

Typical BPH hanger sloped down, skewed right, high side flush shown

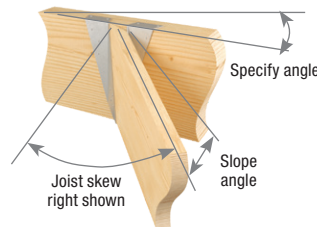

Typical BPH hanger skewed right, sloped down, top flange sloped

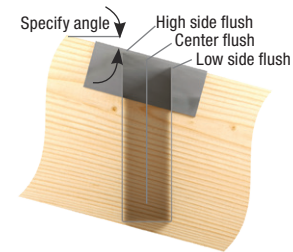

Typical BPH hanger sloped down top flange right shown
(this configuration will not be open back)

Solid Top Flange Hanger Specialty Details

See Specialty Options Chart for each hanger series for load reductions and hanger maximum range of skew, slope, etc.

Skewed Hanger:

- Joist nails may be located on obtuse angle side by MiTek designer to ensure proper nailing.
- Specify skew angle, type (square cut or bevel cut), and direction when ordering.

Sloped Seat Hanger:

- Additional nail holes may be added to joist flanges by MiTek designer.
- Specify slope angle, direction, and joist height when ordering.

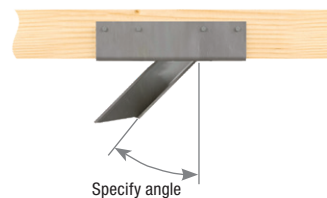

Typical HLBH hanger skewed, left shown
(bevel cut)

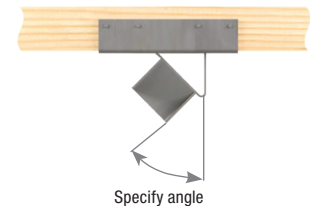

Typical HLBH hanger skewed, left shown
(square cut)

Continued on next page

Solid Top Flange Hanger Specialty Details

Specialty Options

Sloped/Skewed Hanger:

- See nailing notes above for both Skewed Hanger and Sloped Seat Hanger.
- Specify skew and slope angles as well as skew/slope directions, and skew type (square cut or bevel cut) when ordering.
- Specify if hanger is to be high side flush, low side flush, or center flush.

Sloped Top Flange Hanger:

- Additional nail holes may be added to top angle by MiTek designer.
- Specify top flange slope and direction when ordering.
- Specify if hanger is to be high side flush, low side flush, or center flush.

Ridge Hanger:

- Specify flush top of beam at center, right side, or left side.
- Specify angle of slope when ordering.

Top Flange Offset Hanger:

- Specify offset, left (L) or right (R), when ordering.

Saddle Hanger:

- Specify saddle width, "SA" when ordering. Allow clearance for saddled member.

Refer to options for HLBH, KGLS, KGLT, KHGLS, KHGLT series or HWUH, KHW, PHM, PHXU, SW, SWH series Special Order Worksheet for ordering instructions at MiTek-US.com.

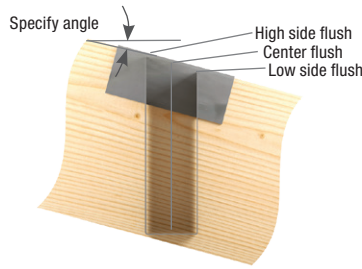

Typical HLBH hanger sloped down top flange, right shown

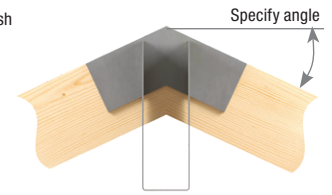

Typical HLBH hanger ridge, top flange slope

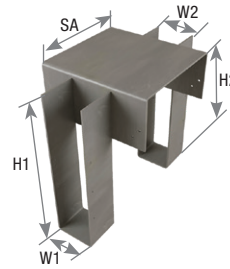

Typical PHXU hanger saddle option



Typical HLBH hanger top flange offset, right shown

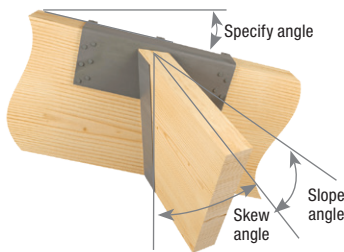

Typical HLBH hanger skewed right, sloped down right, top flange sloped

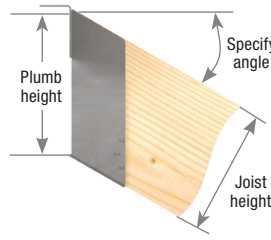

Typical HLBH hanger sloped seat, down shown

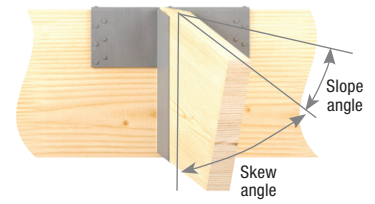

Typical HLBH hanger sloped down, skewed right, center flush shown

Top Flange Hanger Nailer Options

MiTek Top Mount Hangers have been tested installed to various nailers. Wood nailers may be installed to the top of steel beams, concrete and masonry walls. The table below represents maximum allowable loads for common top mount hangers installed on 2x, 2-ply 2x, 3x and 4x nailers.

For additional Nailer Installation information see page 203.

MiTek Series	Nailer Size	Fastener Schedule					DF/SP Allowable Loads (Lbs.) ¹		SPF/HF Allowable Loads (Lbs.) ¹	
		Nailer		Joist			Download 100%	Uplift 160% ²	Download 100%	Uplift 160% ²
		Top Qty	Face Qty	Type ^{5,6}	Qty	Type ^{5,6}				
BPH	2x	4	2	10d x 1-1/2	4	10d x 1-1/2	2080	230	1790	200
	3x	4	4	16d x 2-1/2	4	10d x 1-1/2	2360	535	2030	460
	(2) 2x	4	4	10d	4	10d x 1-1/2	2310	535	1985	460
	4x	4	4	16d	4	10d x 1-1/2	2245	535	1930	460
HBPH	2x	6	2	10d x 1-1/2	10	16d	2540	--	2135	--
	3x	6	6	16d x 2-1/2	10	10d	4500	--	3780	--
	(2) 2x	6	8	10d	10	16d	4140	1610	3480	1350
	4x	6	10	16d	10	16d	5745	1610	4825	1350

Continued on next page

MiTek Series	Nailer Size	Fastener Schedule					DF/SP		SPF/HF	
		Nailer			Joist		Allowable Loads (Lbs.) ¹		Allowable Loads (Lbs.) ¹	
		Top Qty	Face Qty	Type ^{5,6}	Qty	Type ^{5,6}	Download 100%	Uplift 160% ²	Download 100%	Uplift 160% ²
HLBH	2x	3	4	10d x 1-1/2	6	10d x 1-1/2	6115	--	5135	--
	3x	3	6	16d x 2-1/2	6	10d	6825	--	5735	--
	(2) 2x	3	8	10d	6	10d x 1-1/2	4385	--	3685	--
	4x	3	8	NA16D-RS	6	10d x 1-1/2	9600	1115	6900	935
KGLT	2x	4	--	WS15	8	WS15	5210	--	4375	--
	3x	4	2	WS15	8	WS15	6655	--	5590	--
	(2) 2x	4	4	WS3	8	WS3	6430	--	5400	--
	4x	4	6	WS3	8	WS3	6040	1925	5075	1615
KHW	3x	4	--	16d x 2-1/2	2	10d	4415	--	3525	--
MSH (18 Gauge)	2x	4	--	10d x 1-1/2	4	10d x 1-1/2	1245	--	1045	--
	3x	4	--	10d x 1-1/2	4	10d x 1-1/2	1245	--	1045	--
	(2) 2x	4	2	10d	4	10d x 1-1/2	1950	--	1540	--
	4x	4	2	10d	4	10d x 1-1/2	1950	--	1540	--
MSH (16 or 14 Gauge)	2x	4	2	10d x 1-1/2	6	10d x 1-1/2	2355	--	1860	--
	3x	4	2	10d x 1-1/2	6	10d x 1-1/2	2355	--	1860	--
	(2) 2x	4	2	16d x 2-1/2	6	10d x 1-1/2	2080	--	1745	--
	4x	4	2	16d x 2-1/2	6	10d x 1-1/2	2080	--	1745	--
PHM	2x	2	--	10d x 1-1/2	2	10d x 1-1/2	3010	--	2140	--
	3x	2	--	16d x 2-1/2	2	10d x 1-1/2	3060	--	2140	--
	(2) 2x	2	--	10d	2	10d x 1-1/2	3060	--	2140	--
	4x	2	--	16d	2	10d x 1-1/2	3060	--	2140	--
PHXU ³ widths > 2-3/4" to < 3-1/2"	2x	4	--	10d x 1-1/2	6	10d x 1-1/2	2585	--	2170	--
	3x	4	2	16d x 2-1/2	6	10d x 1-1/2	3855	--	3150	--
	(2) 2x	4	2	10d	6	10d x 1-1/2	3590	--	3015	--
	4x	4	4	16d	6	10d x 1-1/2	4420	870	3150	730
PHXU widths ≥ 3-1/2"	2x	4	--	10d x 1-1/2	6	10d	2765	--	2325	--
	3x	4	2	16d x 2-1/2	6	10d	3895	--	3270	--
	(2) 2x	4	2	10d	6	10d	3785	--	3180	--
	4x	4	4	16d	6	10d x 1-1/2	5285	970	4545	835
	4x	4	4	16d	6	10d	5285	1120	4545	940
SW ⁴ widths ≥ 2-9/16"	2x	2	--	10d x 1-1/2	2	10d x 1-1/2	1635	--	1115	--
	3x	2	--	16d x 2-1/2	2	10d x 1-1/2	2390	--	2010	--
	(2) 2x	2	--	16d x 2-1/2	2	10d x 1-1/2	2390	--	2010	--
	4x	2	--	16d x 2-1/2	2	10d x 1-1/2	2390	--	2010	--
SWH	2x	2	--	10d x 1-1/2	2	10d	2600	--	1770	--
	3x	2	--	16d x 2-1/2	2	10d	3305	--	2280	--
	(2) 2x	2	--	16d x 2-1/2	2	10d	3305	--	2280	--
	4x	2	--	16d x 2-1/2	2	10d	3305	--	2280	--
TFI	2x	4	2	10d x 1-1/2	2	10d x 1-1/2	1985	215	1665	180
	3x	4	6	16d x 2-1/2	2	10d x 1-1/2	2715	215	2075	180
	(2) 2x	4	6	10d	2	10d x 1-1/2	2715	215	2075	180
	4x	4	2	16d	2	10d x 1-1/2	2560	215	2075	180
TFL	2x	4	2	10d x 1-1/2	2	10d x 1-1/2	1270	130	1090	110
	3x	4	2	16d x 2-1/2	2	10d x 1-1/2	1600	130	1260	110
	(2) 2x	4	2	10d	2	10d x 1-1/2	1280	130	1100	110
	4x	4	2	16d	2	10d x 1-1/2	1745	130	1260	110
THO	2x	4	2	10d x 1-1/2	2	10d x 1-1/2	1235	230	950	195
	3x	4	2	16d x 2-1/2	2	10d x 1-1/2	1235	230	950	195
	(2) 2x	4	2	16d x 2-1/2	2	10d x 1-1/2	1235	230	950	195
	4x	4	2	16d	2	10d x 1-1/2	1235	230	950	195
THO (Double)	2x	4	2	10d x 1-1/2	2	10d	1455	230	1250	195
	3x	4	2	16d x 2-1/2	2	10d	2335	230	1815	195
	(2) 2x	4	2	10d	2	10d	2370	230	1815	195
	4x	4	2	16d	2	10d	2525	230	1815	195

1) Allowable loads are valid for hanger height ≤ 20". For hanger height ≥ 22", consult MiTek Engineering.
 2) Uplift loads have been increased 60% for wind or seismic loads; no further increase shall be permitted.
 3) PHXU hangers with a width of less than 2-3/4" are limited to 4,350 lbs of download.
 4) SW hangers with a width of less than 2-9/16" are limited to 2,315 lbs. of download.
 5) **MiTek SCREWS:** WS15 structural wood screws are 1/4" dia. x 1-1/2" long and are not included with KGLT hangers. WS3 structural wood screws are 1/4" dia. x 3" long and are included with KGLT hangers.
 6) **NAILS:** 10d x 1-1/2" nails are 0.148" x 1-1/2" long, 10d nails are 0.148" dia x 3" long, NA16D-RS nails are 0.148" x 3-1/2" long, 16d x 2-1/2" nails are 0.162" dia. x 2-1/2" long, 16d nails are 0.162" dia. x 3-1/2" long.
 Updated product information is designated in blue font.

Welded Top Flange

- Weld sizes and lengths shown on chart.
- Weld-on applications produce maximum allowable load listed. **Uplift loads do not apply to this application.**
- All welding should be done in accordance with the American Welding Society (AWS) Standard by a certified welder.
Caution: Welding galvanized steel may produce harmful fumes and should only be performed in well-ventilated environments.

Specialty Options



Typical top flange welded installation

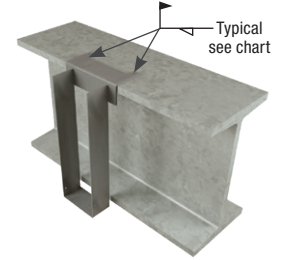

Typical top angle welded installation

Top Angle Weld Length Chart

MiTek Welded Hanger Series	Weld Length
SW	3"
BPH, FWH, HBPH, PHM, SWH	4"
FWHBP, FWHFM, FWHH, KLB, KHW, PHXU	6"
KB, KGB, KHGB, KHHB, KGLS, KGLST, KGLT, KHGLS, KHGLST	8"
HLBH, KHGLT	10"

Top Angle Steel Gauge	Weld Size
14 - 10 gauge	1/8"
7 gauge	3/16"
3 gauge	1/4"

Weld shall be distributed evenly.

Part Number System

Part Numbers assigned to TFL, THO, IHFL, IHF, THFI and THF I-Joist hangers reveal the I-Joist sizes to be used with the specific hanger. This guide will teach you how to recognize I-Joist dimensions in the part numbers.

1st, 3rd, and sometimes 4th digits are whole numbers
 (This example denotes 2 and 11)
 4th digit may be part of a decimal –



2nd and 5th digits are decimals
 (see guide below)
 (This example denotes .3125
 [5/16] and .875 [7/8])
 5th digit may be (0) or dropped if height is even

Part Number Guide for Decimals

1 = .125	or	1/8 inch
2 or 25 = .25	or	1/4 inch
3 = .3125	or	5/16 inch
5 = .5	or	1/2 inch
6 = .625	or	5/8 inch
7 = .75	or	3/4 inch
8 = .875	or	7/8 inch

THO35925-2

THO

Letters refer to Hanger Series
 ex.: THO

35

First (2) Digits refer to Member Width
 ex.: 3.5 inches

925

Last (2) or (3) Digits refer to Member Height
 ex.: 9.25 inches

-2

Digits after Dash refer to Number of Plies
 ex.: 2-ply

Some Examples:

THO15950 1-1/2" x 9-1/2"

IHFL17925..... 1-3/4" x 9-1/4"

THO16925-2 double 1-5/8" x 9-1/4"

THF23925-2..... double 2-5/16" x 9-1/4"

Note: MiTek's Product Catalog lists a range of heights for IHFL/IHF hangers. Face mount hangers can usually accommodate more than one I-Joist height. The hanger height must be tall enough to support the top chord of the I-Joist to eliminate web stiffener requirements for lateral stability. The IHFL/IHF hanger must be a minimum of 60% of the joist height.

CFS CONNECTORS

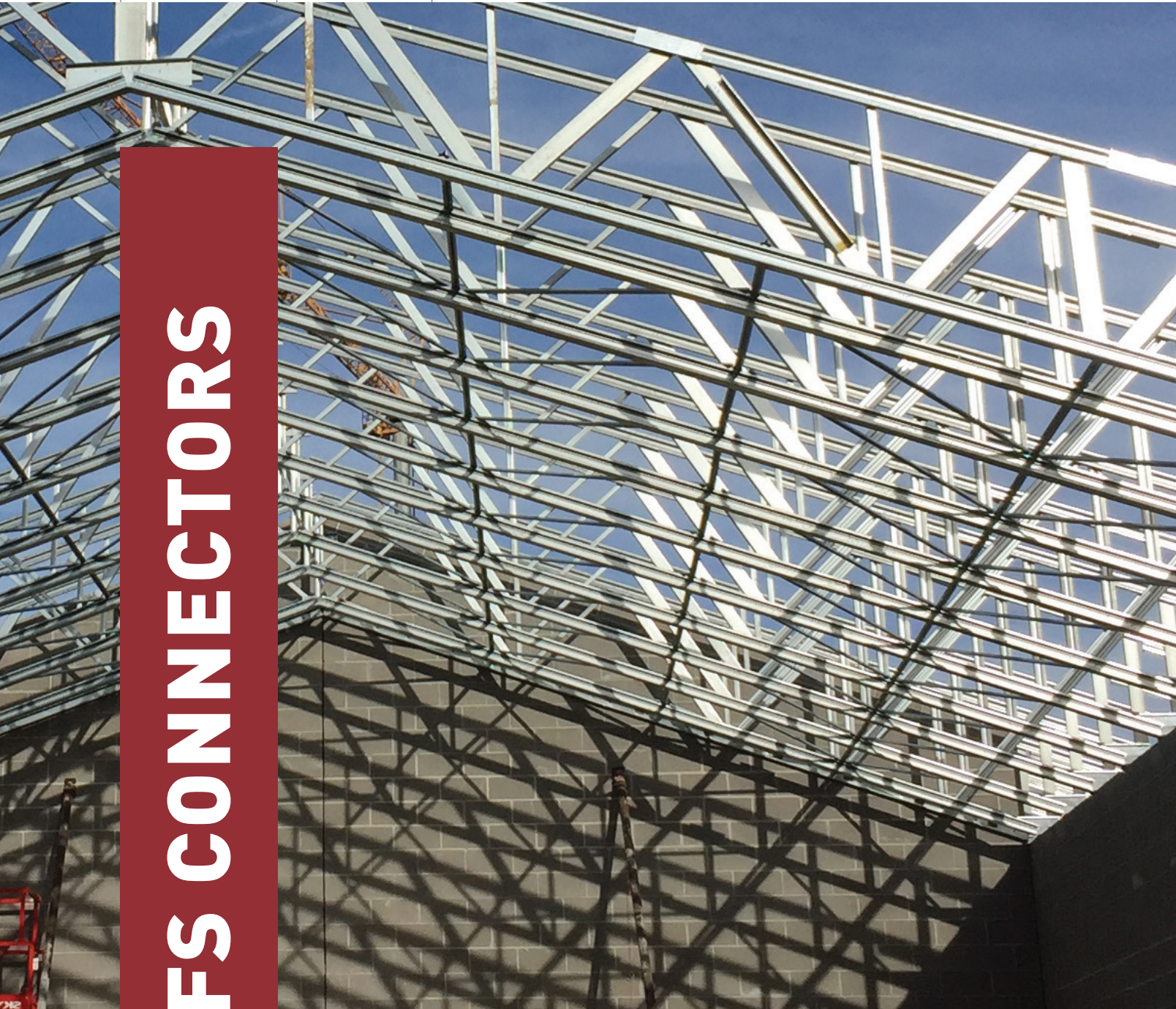

CFS CONNECTORS

328-339

Angles	333
Concrete Screw Anchors	329
Fastening Information	328
Girder Tiedowns	338
Hangers	335-337
Holdowns	330-332
Hurricane Ties	339
Straps	334
Stud Plate Ties	338



MiTek recommends the use of hex head metal screws with a self-drilling tip, for ease of installation and strength. Screw diameter ranges from 0.190" to 0.250" and is specified for each connector in their corresponding load table.

An important factor to consider when selecting a self-drilling screw is the material thickness specifically the combined side and main member thickness. Care should be taken by the designer to verify that the drill point and thread length are long enough to appropriately fasten the members per the fasteners manufacturers specifications.

The drill point is the unthreaded section from the screw tip to the first thread. This length must be long enough to completely drill through the material before the threads engage. If the threads engage too early, they can cause the fastener to bind and break.



Specification Table

Screw Size	Nominal Diameter d (in)	Washer Diameter d _w (in)	Allowable Screw Shear Strength (P _{ss} /Ω)	Allowable Shear Connection Strength (P _{ns} /Ω, P _{ss} /Ω)					Allowable Screw Tension Strength (P _{ts} /Ω)	Allowable Tensile Pull-Out Strength (P _{not} /Ω, P _{ts} /Ω)				
				Steel Thickness mil (gauge)						Steel Thickness mil (gauge)				
				33–33	43–43	54–54	68–68	97–97		33	43	54	68	97
				(20–20)	(18–18)	(16–16)	(14–14)	(12–12)		(20)	(18)	(16)	(14)	(12)
#10 x 1/2"	0.190	0.375	548	177	263	370	523	548	386	84	109	137	173	246
#12 x 3/4"	0.216	0.375	775	188	280	394	557	775	777	95	124	156	196	280
#14 x 3/4"	0.250	0.500	1016	203	302	424	600	1016	1067	110	144	180	227	324

- 1) Allowable loads are per AISI S-100 and are for use when utilizing the traditional Allowable Stress Design methodology. The tabulated loads may be multiplied by a Factor of Safety (Ω) of 3 to determine the screw nominal strength. The LRFD load may be determined by multiplying the allowable screw load by the ASD safety factor of 3 then by Resistance Factor (φ) of 0.50.
- 2) Allowable loads may not be increased for wind or seismic load unless otherwise noted.
- 3) Allowable loads are based on cold-formed steel members with a minimum yield strength, F_y, of 33 ksi and tensile strength, with an F_u, of 45 ksi.
- 4) Allowable loads are based on design steel thickness for 33 mil = 0.036", 43 mil = 0.048", 54 mil = 0.060", 68 mil = 0.075", and 97 mil = 0.105" with the #10, #12 and #14 screws having of minimum nominal shear strength of 1650 lbs, 2325 lbs and 3050 lbs respectively.
- 5) Self-drilling tapping screw fasteners for steel-to-steel connections used for connectors in this catalog shall be in compliance with ASTM C1513.
- 6) Screw diameters used in the calculation of shear loads per ANSI/ASME standard.

Screw-Bolt+ anchors are a one-piece, heavy duty screw anchor with a finished hex head. The patented thread design, designed for use with standard ANSI drill bits, reduces installation torque and enhances productivity. The steel threads along the anchor body tap into the hole during installation to provide keyed engagement and allow for reduced edge and spacing distances.



Diameter and length identification mark



Screw-Bolt™ +
(zinc plated)

Finish: Zinc Plated or Mechanically Galvanized

Codes: IBC, FL, LA

Zinc Plated		Mechanically Galvanized		Anchor Size (in) ¹	Hole Size (in)	Socket Size (in)	Code Ref.
MiTek Stock No.	Ref. No.	MiTek Stock No.	Ref. No.				
PFM1411000	THDB25178H	--	--	1/4 x 1-1/4	1/4	7/16	IBC, FL, LA
PFM1411020	THD25134H	--	--	1/4 x 1-3/4			
PFM1411060	THD25214H	--	--	1/4 x 2-1/4			
PFM1411100	THDB25300H	--	--	1/4 x 3	3/8	9/16	
PFM1411160	THD37134H	--	--	3/8 x 1-3/4			
PFM1411220	THD37212H	--	--	3/8 x 2-1/2			
PFM1411240	THD37300H	--	--	3/8 x 3			
PFM1411280	THD37400H	PFM1461280	THD37400HMG	3/8 x 4			
PFM1411300	THD37500H	PFM1461300	THD37500HMG	3/8 x 5			
PFM1411320	THD37600H	PFM1461320	THD37600HMG	3/8 x 6	1/2	3/4	
PFM1411340	--	--	--	1/2 x 2			
PFM1411360	--	--	--	1/2 x 2-1/2			
PFM1411380	THD50300H	--	--	1/2 x 3			
PFM1411420	THD50400H	PFM1461420	THD50400HMG	1/2 x 4			
PFM1411460	THD50500H	PFM1461460	THD50500HMG	1/2 x 5			
PFM1411480	THD50600H	PFM1461480	THD50600HMG	1/2 x 6			
PFM1411520	THD50800H	PFM1461520	THD50800HMG	1/2 x 8			
PFM1411540	--	--	--	5/8 x 3	5/8	15/16	
PFM1411580	THD62400H	--	--	5/8 x 4			
PFM1411600	THD62500H	PFM1461600	THD62500HMG	5/8 x 5			
PFM1411640	THD62600H	PFM1461640	THD62600HMG	5/8 x 6			
PFM1411680	THD62800H	PFM1461680	THD62800HMG	5/8 x 8	3/4	1-1/8	
PFM1411700	--	--	--	3/4 x 3			
PFM1411720	THD75400H	--	--	3/4 x 4			
PFM1411760	THD75500H	--	--	3/4 x 5			
PFM1411800	THD75600H	PFM1461800	THD75600HMG	3/4 x 6			
PFM1411840	THD75812H	--	--	3/4 x 8			
--	--	PFM1461850	THD75812HMG	3/4 x 8-1/2			
PFM1411880	THD75100H	--	--	3/4 x 10			

1) The anchor size includes the diameter and length of the anchor measured from under the head.

The S/PHD holdowns are high performance ductile holdowns used for providing a tension connection between CFS framing members and the foundation or other structural members. The pre-deflected design keeps deflection low. The S/PHD holdowns attach with #14 self-drilling screws to fasten to CFS framing members.

Materials: S/PHD4, S/PHD6 – 14 gauge; S/PHD9 – 12 gauge
Finish: G90 galvanizing
Codes: IBC

Installation:

- Use all specified fasteners.
- Place the S/PHD over the anchor bolt. No washer is required.
- Install with standard #14 self-drilling (tapping) screws to fasten to CFS framing members.
- Tighten anchor bolt nuts finger tight to base plus 1/3 to 1/2 additional turns with a wrench.
- S/PHD Holdowns installed elevated more than 4" off the base track may have higher deflection values.
- The design engineer may specify any alternate anchorage calculated to resist the tension load for a specific application. Anchor rod exposure length should take the bearing plate height of 1-5/8" into account, anchor bolt thread should visibly extend above nut.
- The built up studs shall be designed to act as a single unit. Holdown specified shall not be considered to attach multiple CFS members together.
- For anchorage options see MiTek's STB/ STBL Anchor Bolt series or ATR threaded rod series products epoxied into place at required depth.



Typical S/PHD installation



Typical S/PHD Corner installation

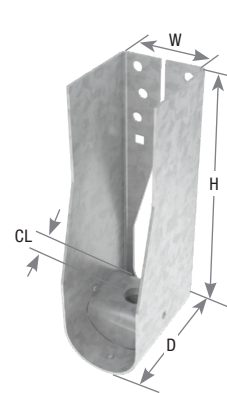

S/PHD4

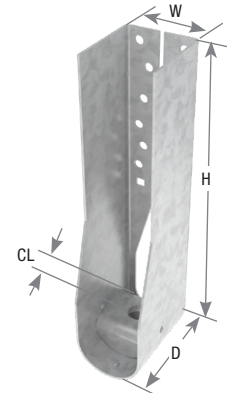

S/PHD6

MiTek Stock No.	Ref. No.	Steel Gauge	Dimensions (in)				Fastener Schedule				Metal Stud Member Mils (Gauge) ⁴	ASD		LRFD		Code Ref.	
			W	H	D	CL	Min/Max	Anchor Bolt ¹		Stud		Tension Load (lbs.)	Deflection (in)	Tension Load (lbs.)	Deflection (in)		
								Qty	Dia (in)	Qty							Type ³
S/PHD4	S/HDU4	14	2-3/8	7-3/4	3-1/4	1-3/8	Min	1	5/8	6	#14	2-33 (20Ga)	2255	0.080	3605	0.118	IBC
												2-43 (18Ga)	3165	0.104	5070	0.149	
												2-54 (16Ga)	3955	0.132	6330	0.188	
							Max	1	5/8	8	#14	2-33 (20Ga)	2960	0.088	4740	0.133	
												2-43 (18Ga)	4375	0.076	7000	0.132	
												2-54 (16Ga)	4595	0.122	7355	0.183	
S/PHD6	S/HDU6	14	2-3/8	10-3/8	3-1/4	1-3/8	Min	1	5/8	12	#14	2-33 (20Ga)	4880	0.100	7805	0.173	
												2-43 (18Ga)	5525	0.105	8840	0.161	
												2-54 (16Ga)	6670	0.108	10670	0.188	
							Max	1	5/8	14	#14	2-33 (20Ga)	5390	0.087	8620	0.166	
												2-43 (18Ga)	6315	0.096	10105	0.157	
												2-54 (16Ga)	6435	0.112	10300	0.183	
S/PHD9	S/HDU9	12	2-3/8	12-3/4	3-1/4	1-3/8	--	1	7/8	18	#14	2-33 (20Ga)	6495	0.096	10390	0.154	
												2-43 (18Ga)	8875	0.112	14195	0.191	
												2-54 (16Ga)	10345	0.099	16345	0.152	

1) The designer must specify the anchor bolt type, length and embedment.
 2) Deflections are derived from static, monotonic load tests of device connected to a 2-ply cold-formed steel stud and include fastener slip, holdown elongation and anchor bolt elongation (L = 4").
 3) #14 screws are self-drilling 0.250 inch diameter hardened washer-head screws with a minimum nominal shear strength of 3050 pounds.
 4) The designer must specify the metal stud size and mil thickness.

Copyright © 2022 MiTek Industries, Inc. All Rights Reserved

The LTS20B and the HTT14S tension ties are designed for both new construction and retrofit applications for concrete-to-steel connections and do not require an additional washer.

LTS20B is a light capacity tension tie strap with a 1/4" load transfer plate.

Materials: See chart

Finish: Strap – G90 galvanizing; Plate – Primer

Installation:

- Use all specified fasteners.
- Attach the strap portion of the connector to the steel stud. Secure the base to the foundation or wall with specified anchor bolt.
- A design professional shall specify the type, length, and embedment of the anchor bolt. No washers are required.



Typical HTT14S installation

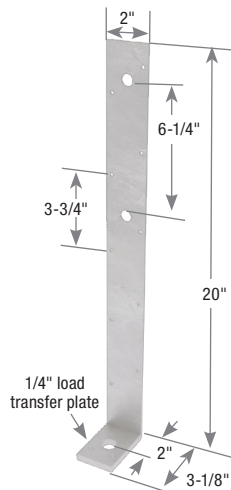

LTS20B

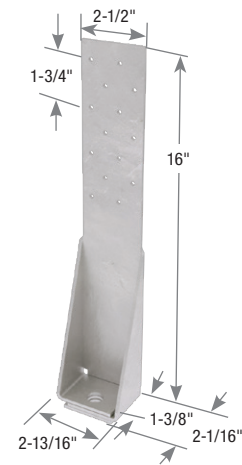

HTT14S

MiTek Stock No.	Ref. No.	Steel Thickness		Fastener Schedule				Allowable Tension Loads (Lbs.) ^{1,2,4}						Code Ref.
		Strap Gauge	Plate (in)	To Sill Plate		To Stud		2-33 mil (2-20ga) Back-to-Back Studs		2-43 mil (2-18ga) Back-to-Back Studs		2-54 mil (2-16ga) Back-to-Back Studs		
				Qty	Dia. (in)	Qty	Type	100%	160%	100%	160%	100%	160%	
LTS20B	S/LTT20	12	1/4	1	3/4	5	#10	885	1140	1090	1090	1210	1210	--
HTT14S	S/HTT14	10	--	1	5/8	14	#10	2480	3290	3680	4425	4825	4825	--

- 1) Back-to-back stud members are required unless otherwise noted.
- 2) Allowable loads at 160% can only be used with codes that permit the use of alternate basic load combinations and when the referenced materials standard permits it.
- 3) Designer shall specify anchor embedment and configuration.
- 4) Designer shall verify the adequacy of the steel studs to transfer the required load.
- 5) #10 screws are self-drilling 0.190 inch diameter hardened washer-head screws with a minimum nominal shear strength of 1650 pounds.

The **TD8S**, **TD10S**, and **TD15S** are high capacity holdowns which are designed for attachment to cold formed steel (CFS) framing members. Holdowns are secured at the base by attachment to an anchor bolt.

Materials: See chart
Finish: Primer

Installation:

- Use #10 self-tapping screws to attach the back or strap portion of the holddown to a steel stud. Install nut to secure the base of holddown to foundation with anchor bolt of specified diameter.
- A design professional shall specify the type, length, and embedment depth of the anchor bolt.
- Install anchor bolt nut to base of holddown until finger tight, then tighten an additional 1/3 to 1/2 turns with a wrench.



TD10S



Typical TD10S installation

MiTek Stock No.	Ref No.	Steel Thickness		Dimensions (in)			Fastener Schedule			CFS Member			ASD		LRFD		Nominal Tension Load ⁶ (in)	Code Ref.
		Body	Base (in)	W	L	CL	Anchor Bolt ² Dia. (in)	Stud Screws ⁴		Stud ^{1,3}			Tension (Lbs.)	Deflection ⁵ (in)	Tension (Lbs.)	Deflection ⁵ (in)		
								Qty	Type	Plies	Mils	Gr						
TD8S	S/HD8S	10	3/8	2-1/2	13-7/8	1-5/8	7/8	24	#10	2	33	33	8250	0.074	13200	0.164	22325	--
										2	43	33	10115	0.109	16350	0.242	27650	
										2	54	50	10900	0.091	17435	0.205	29485	
TD10S	S/HD10S	10	3/8	2-1/2	16-1/8	1-5/8	7/8	30	#10	2	33	33	8690	0.071	13900	0.159	24575	
										2	43	33	9310	0.076	14900	0.195	26335	
										2	54	50	9985	0.058	15975	0.146	28235	
TD15S	S/HD15S	7	1/2	2-5/8	21-1/2	1-11/16	1	48	#10	2	33	33	11780	0.075	18845	0.146	33410	
										2	43	33	13770	0.100	22035	0.192	39065	
										2	54	50	15920	0.096	25475	0.144	45160	

- 1) Back-to-back stud members are required.
- 2) The designer must specify anchor bolt type, length, and embedment.
- 3) Designer shall verify the adequacy of the steel studs to transfer the required load.
- 4) #10 screws are self-drilling 0.190 inch diameter hardened washer-head screws with a minimum nominal shear strength of 1650 pounds.
- 5) Holddown deflection at ASD and LRFD static test load includes fastener slip, holddown deflection, and anchor bolt elongation.
- 6) The nominal tension load is based on the average of the ultimate tested values.

Copyright © 2022 MiTek Industries, Inc. All Rights Reserved

MP/S angles are field-adjustable to attach members intersecting at angles. MP/S angles are load rated and provide adequate thickness and fastener quantity to the field fabricated clip angles.

Materials: 18 gauge
Finish: G90 galvanizing

- Installation:**
- Use all specified fasteners.
 - Field-adjustable from 45°-180° (flat). Bend angle only once.
 - Joist must be constrained from rotation.

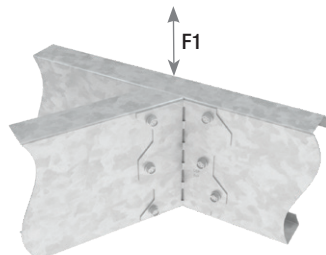
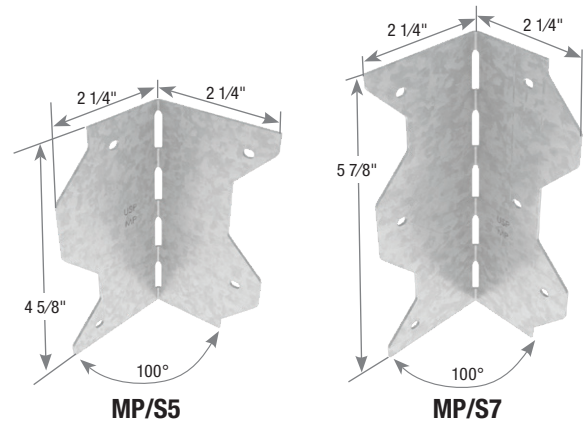

Typical MP/S7 installation
(MP/S5 similar)

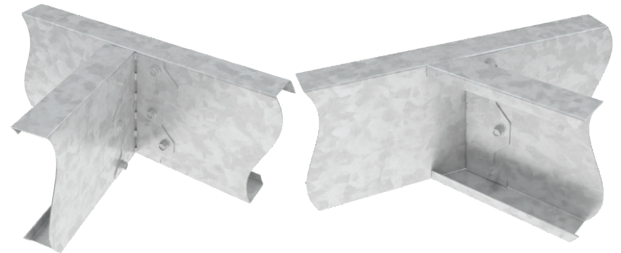

Typical MP/S7 skew installation
(MP/S5 similar)

MiTek Stock No.	Ref. No.	Steel Gauge	Fastener Schedule		Allowable F1 Loads (Lbs.) ¹			Code Ref.
			Qty	Type ³	33 mil ² (20ga)	43 mil ² (18ga)	54 mil ² (16ga)	
MP/S5	S/LS50	18	4	#10	310	410	480	--
MP/S7	S/LS70	18	6	#10	405	640	745	--

1) Allowable loads are for one part only.
 2) Member mils (33, 43, 54) has been considered as Grade 33.
 3) #10 screws are self-drilling 0.190 inch diameter hardened washer-head screws with a minimum nominal shear strength of 1650 pounds.

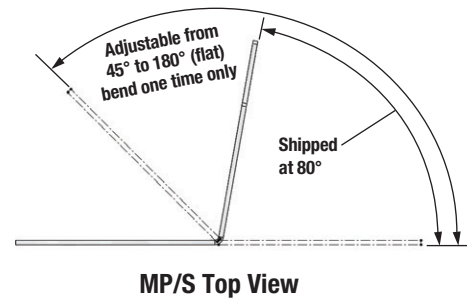

MiTek straps may be used to create a tension connection between multiple CFS members with the use of self-tapping screws.

Materials: See chart
Finish: G90 galvanizing

Installation:

- Use all specified fasteners.
- Install equal amount of screws on each end of tension connection.

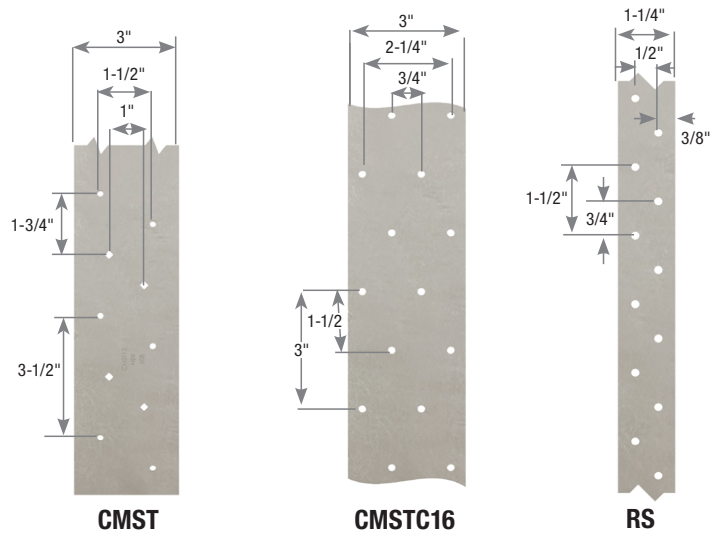

MiTek Stock No.	Ref. No.	Steel Gauge	Dimensions		Fastener O.C. Spacing (in)	Fastener Schedule				Allowable Shear Loads (Lbs.)			Allowable Tension Loads (Lbs.) ¹			Code Ref.			
			W (in)	Coil Length (ft)		Min Qty ^{3,4}			Type ^{2,5}	33 mil (20ga)	43 mil (18ga)	54 mil (16ga)	33 mil (20ga)	43 mil (18ga)	54 mil (16ga)		33 mil (20ga)	43 mil (18ga)	54 mil (16ga)
						33 mil (20ga)	43 mil (18ga)	54 mil (16ga)											
CMST12	CMST12	12	3	40'	1-3/4	106	72	36	#10	177	263	534	9318						
CMST14	CMST14	14	3	52-1/2'	1-3/4	76	52	26	#10	177	263	534	6630						
CMSTC16	CMSTC16	16	3	54'	1-1/2	54	36	18	#10	177	263	534	4715						
RS20-R	CS20-R	20	1-1/4	25'	1-1/2	12	8	8	#10	177	276	329	1045						
RS250	CS20			250'															
RS18-R	CS18-R	18	1-1/4	25'	1-1/2	16	12	8	#10	177	263	433	1375			--			
RS100	--			100'															
RS200	CS18			200'															
RS16-R	CS16-R	16	1-1/4	25'	1-1/2	20	14	8	#10	177	263	534	1732						
RS150	CS16			150'															
RS14-R	CS14-R	14	1-1/4	25'	1-1/2	30	20	10	#10	177	263	534	2612						
RS14-100	CS14			100'															

1) Allowable load is tension capacity of the strap based on the total quantity of screws installed in the strap to develop full tension strength.
 2) Allowable loads are based on Grade 33 steel for 43 mil (18 ga) and thinner CFS members and Grade 50 steel for 54 mil (16 ga) and thicker CFS members.
 3) Install half the total quantity of fasteners on each end of the strap to achieve full tension load of strap.
 4) Minimum quantity of fasteners to be installed with equal fasteners at each end of the connection. Product may have additional holes not needed to meet the published allowable load of the strap.
 5) #10 screws are self-drilling 0.190 inch diameter hardened washer-head screws with a minimum nominal shear strength of 1650 pounds.

HD0/S / HDOL/S Top Mount Bridle Hangers

Cold-Formed Steel Connectors

HDOL/S (14 ga) and HD0/S (12 ga) top mount bridle hangers are available in a wide variety of stock sizes to match the most common framing needs with economical solutions where custom or special order hangers were required before. The revolutionary design utilizes shear lag slots designed to maximize the capacity of the hangers while providing a safe and ductile connection.

The HDOL/S and HD0/S hangers may be installed with screws, powder actuated, or welded to the header.

Materials: HDOL/S 68mil (14 gauge), HD0/S 97mil (12 gauge)
Finish: G90 galvanizing
Patents: U.S. Patent No. 10,662,641, U.S. Patent No. 10,072,412

Installation:

- Install prescribed type and number of self-drilling screws in to the round holes of the hangers. Do not install screws in the shear lag slots.
- Powder actuated fasteners are permitted.
- Welding of the hangers is permitted. Place a minimum 1/8" x 2" fillet weld on each top flange of the hanger. Welding should be performed by a qualified welder using a qualified welding procedure while distributing the weld evenly across both flanges. Weld-on applications produce maximum allowable load listed. **Uplift loads do not apply to this application.**

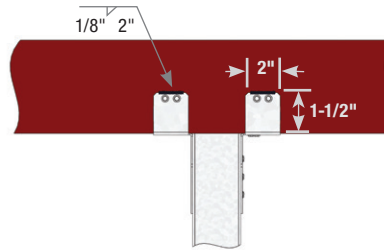
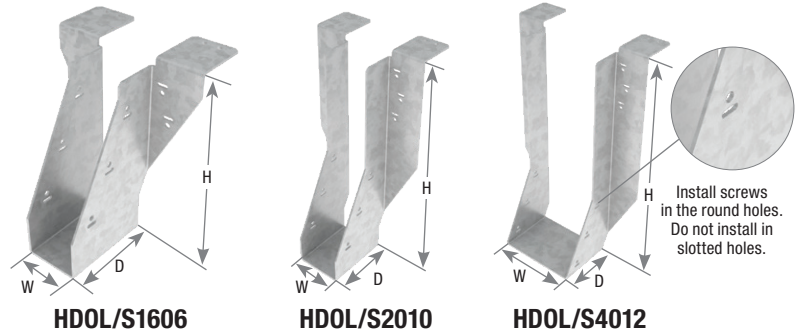

Top view detail of welds

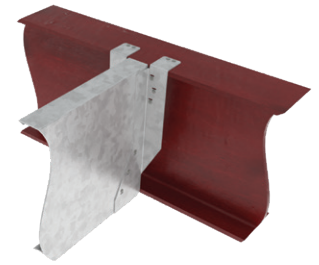

Typical HDOL/S1616 (I-beam) installation

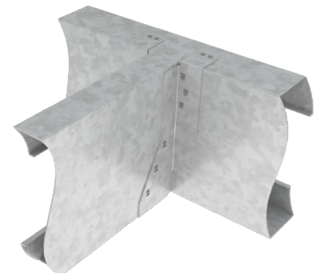

Typical HDOL/S2010 (CFS Header) installation

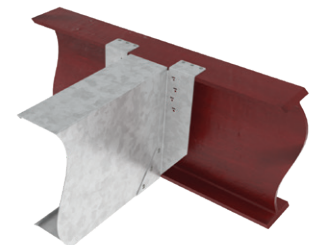

Typical HDOL/S4012 (I-beam) installation

MiTek Stock No.	Ref. No.	Steel Gauge	Dimensions (in)			Fastener Schedule					Allowable Loads ^{1,2,3}	Code Ref.
			W	H	D	Header		Joist				
						Top Qty	Face Qty	Type ⁴	Qty	Type ⁴		
HDOL/S1606	S/LBV1.68/6	14	1-5/8	6	3	4	6	#10	3	#10	2950	--
HDO/S1606	S/B1.68/6	12			3-1/2	6	8				6140	
HDOL/S1608	S/LBV1.68/8	14	1-5/8	8	3	4	6	#10	3	#10	2950	
HDO/S1608	S/B1.68/8	12			3-1/2	6	8				6140	
HDOL/S1610	S/LBV1.68/10	14	1-5/8	10	3	4	6	#10	3	#10	2950	
HDO/S1610	S/B1.68/10	12			3-1/2	6	8				6140	
HDOL/S1612	S/LBV1.68/12	14	1-5/8	12	3	4	6	#10	3	#10	2950	
HDO/S1612	S/B1.68/12	12			3-1/2	6	8				6140	
HDOL/S2006	S/LBV2.06/6	14	2	6	3	4	6	#10	3	#10	2950	
HDO/S2006	S/B2.06/6	12			3-1/2	6	8				6140	
HDOL/S2008	S/LBV2.06/8	14	2	8	3	4	6	#10	3	#10	2950	
HDO/S2008	S/B2.06/8	12			3-1/2	6	8				6140	
HDOL/S2010	S/LBV2.06/10	14	2	10	3	4	6	#10	3	#10	2950	
HDO/S2010	S/B2.06/10	12			3-1/2	6	8				6140	
HDOL/S2012	S/LBV2.06/12	14	2	12	3	4	6	#10	3	#10	2950	
HDO/S2012	S/B2.06/12	12			3-1/2	6	8				6140	
HDOL/S4006	S/LBV4.06/6	14	4	6	3	4	6	#10	3	#10	2950	
HDO/S4006	S/B4.06/6	12			3-1/2	6	8				6140	
HDOL/S4008	S/LBV4.06/8	14	4	8	3	4	6	#10	3	#10	2950	
HDO/S4008	S/B4.06/8	12			3-1/2	6	8				6140	
HDOL/S4010	S/LBV4.06/10	14	4	10	3	4	6	#10	3	#10	2950	
HDO/S4010	S/B4.06/10	12			3-1/2	6	8				6140	
HDOL/S4012	S/LBV4.06/12	14	4	12	3	4	6	#10	3	#10	2950	
HDO/S4012	S/B4.06/12	12			3-1/2	6	8				6140	

1) Testing of HDOL/S and HDO/S hangers was performed with framing members with minimum steel yield strengths of Fy=50 ksi.
 2) Qualified designer shall design connection to ensure the header is designed to carry the load and the joist member is sufficient to transfer load to hanger.
 3) Allowable loads based on testing with 68 mil (14ga) CFS members for the HDOL/S hanger and 97 mil (12ga) CFS members for the HDO/S hanger.
 4) #10 screws are self-drilling 0.190 inch diameter hardened washer-head screws with a minimum nominal shear strength of 1650 pounds.

The FWH/S Fire Wall Hanger attaches to cold-formed steel wall framing to support cold-formed steel joists.

Materials: 14 gauge
Finish: G90 galvanizing
Options: See Specialty Options chart

Installation:

- Install prescribed type and number of self-drilling screws through the round holes into the wall track. Install (5) self-drilling screws through the hanger into one side of the joist using the round and slotted holes.
- Powder actuated fasteners are permitted.
- Welding of the hangers is permitted. Place a minimum 1/8" x 2" fillet weld on each top flange of the hanger. Welding should be performed by a qualified welder using a qualified welding procedure while distributing the weld evenly across both flanges. Weld-on applications produce maximum allowable load listed. **Uplift loads do not apply to this application.**

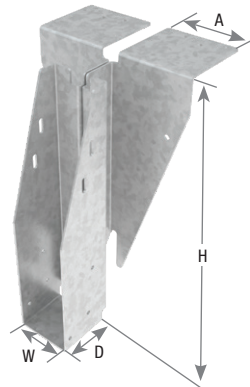

FWH/S

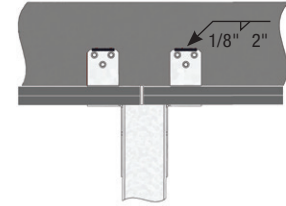

Top view detail of welds

Geometry Table

MiTek Stock No.	Ref. No.	Dimensions (in)				Code Ref.
		W	H	D	A	
FWH/S1608	--	1-11/16	7-15/16	2	2-3/4	--
FWH/S1610	--	1-11/16	9-15/16	2	2-3/4	
FWH/S1612	--	1-11/16	11-15/16	2	2-3/4	
FWH/S2008	--	2-1/16	7-15/16	2	2-3/4	
FWH/S2010	--	2-1/16	9-15/16	2	2-3/4	
FWH/S2012	--	2-1/16	11-15/16	2	2-3/4	
FWH/S2508	--	2-9/16	7-15/16	2	2-3/4	
FWH/S2510	--	2-9/16	9-15/16	2	2-3/4	
FWH/S2512	--	2-9/16	11-15/16	2	2-3/4	

New products or updated product information are designated in **blue font**.

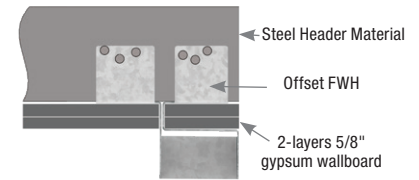

Typical FWH top flange offset, left shown (Top View)

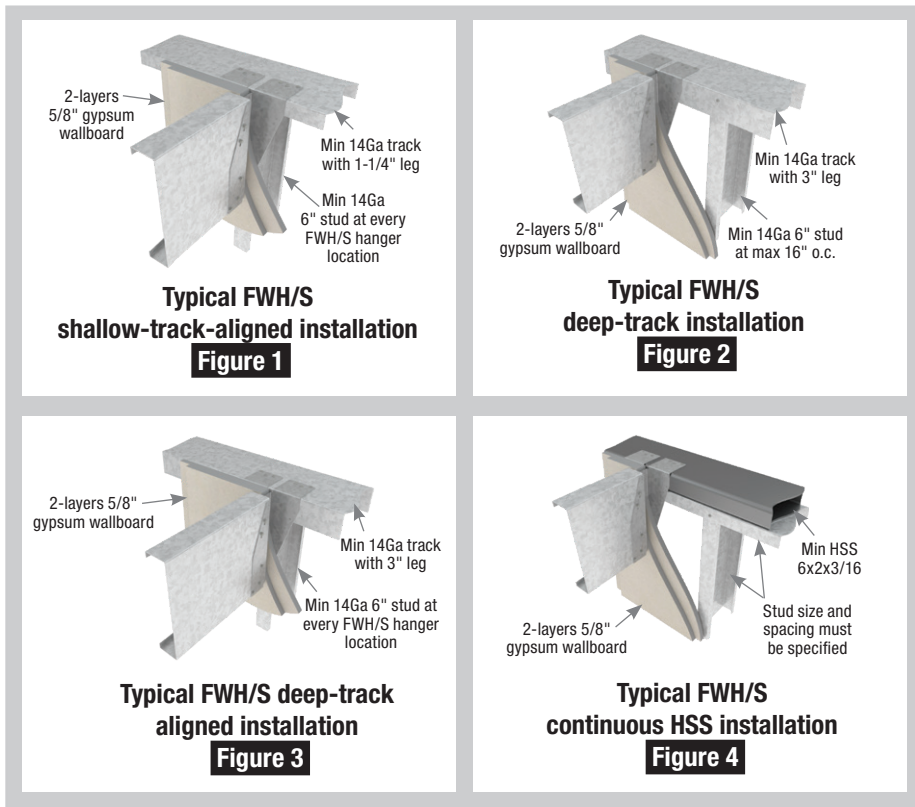

Fastener / Allowable Load Table

Installation Type	Description	Fastener Schedule				Joist Steel Thickness	Allowable Download (Lbs.)		
		Header		Joist Qty	Type ^{1,2}		Without Bearing Stiffeners	With ³ Bearing Stiffeners	Uplift
		Top Qty	Face Qty						
Figure 1	14Ga 6" CFS Track (1-1/4" Leg) with 14Ga 6" Stud Directly Below	6	--	5	#10 Self-Tapping	54 mil	625	1165	180
						68 mil	875	1800	
						97 mil	1750		
Figure 2	14Ga 6" CFS Deep Track (3" Leg) with No Stud Directly Below	6	2	5	#10 Self-Tapping	54 mil	625	1165	380
						68 mil	875	1220	
						97 mil	1750		
Figure 3	14Ga 6" CFS Deep Track (3" Leg) with 14Ga 6" Stud Directly Below	6	2	5	#10 Self-Tapping	54 mil	625	1165	380
						68 mil	875	2200	
						97 mil	1750		
Figure 4	HSS 6x2x3/16 on 14Ga CFS Track (1-1/4" Leg) with No Stud Directly Below	6	--	5	#10 Self-Tapping	54 mil	625	1165	180
						68 mil	875	2200	
						97 mil	1750		

- 1) #10 screws are self-drilling 0.190 inch diameter hardened washer-head screws with a minimum nominal shear strength of 1650 pounds.
- 2) Larger self-drilling/tapping screws may be used with no reduction in load carrying capacity.
- 3) Tested with 400T125-68 bearing stiffener. Thicker gauge bearing stiffeners may also be used.

Specialty Options Chart – Refer to Specialty Options pages 320 and 322 for additional details.

Option	Skewed ¹	Top Flange Offset
Range	1° to 70°	--
Allowable Loads	70% of table load	70% of table download. 180 lbs. Max uplift
Ordering	Add <i>SK</i> , angle required, right (<i>R</i>) or left (<i>L</i>), and square cut (<i>SQ</i>) to product number. Ex. FWH/S2010_SK45R_SQ	Add <i>OS</i> , and right (<i>R</i>) or left (<i>L</i>), to product number. Ex. FWH/S2010_OL

1) Skewed hangers with skews greater than 15° may have all joist nailing on outside flange.

Copyright © 2022 MiTek Industries, Inc. All Rights Reserved

SPT Stud Plate Ties

Cold-Formed Steel Connectors

MiTek SPT4 and SPT6 Stud Plate Ties may be used to create a tension and bearing connection between multiple CFS members with self-tapping screws.

Materials: 20 gauge

Finish: G90 galvanizing

Installation:

- Wrap SPT tie around top or bottom track.
- Use all specified fasteners.

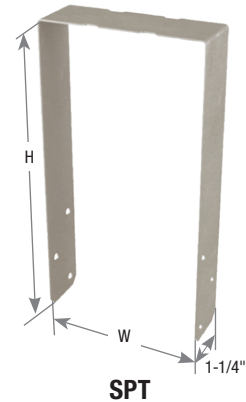

MiTek Stock No.	Ref. No.	Steel Gauge	Dimensions (in)		Fastener Schedule		Allowable Uplift Loads 100% (Lbs.) ¹			Code Ref.
			W	H	Qty	Type ²	33 mil (20 ga)	43 mil (18 ga)	54 mil (16 ga)	
SPT4	SP4	20	3-9/16	6-7/8	6	#10	530	830	985	--
SPT6	SP6	20	5-9/16	7-5/8	6	#10	530	830	985	--

1) Allowable loads are based on Grade 33 steel for 43 mil (18 ga) or thinner CFS members and Grade 50 steel for 54 mil (16 ga) or thicker CFS members.

2) #10 screws are self-drilling 0.190 inch diameter hardened washer-head screws with a minimum nominal shear strength of 1650 pounds.

LUGT Girder Tiedown

The LUGT is designed to transfer uplift loads from roof framing members to the wall studs.

Materials: 20 gauge

Finish: G90 galvanizing

Installation:

- Use all specified fasteners.

MiTek Stock No.	Ref. No.	Steel Gauge	Fastener Schedule				Allowable Shear Loads (Lbs.)			Allowable Tension Loads (Lbs.) ²			Code Ref.
			Min Qty ³			Type ^{1,4,5}	33 mil (20ga)	43 mil (18ga)	54 mil (16ga)	33 mil (20ga)	43 mil (18ga)	54 mil (16ga)	
			33 mil (20ga)	43 mil (18ga)	54 mil (16ga)								
LUGT1	H10S	18	6	4	4	#10	177	263	433	1045	--		

1) Install self-tapping screws symmetrically into CFS stud to prevent any eccentricity.

2) Allowable load is based on allowable tension capacity of truss to connector. Be sure to install all prescribed nails.

3) Minimum quantity of fasteners to be installed. Product may have additional holes not needed to meet the published allowable load.

4) #10 screws are self-drilling 0.190 inch diameter hardened washer-head screws with a minimum nominal shear strength of 1650 pounds.

5) Allowable loads are based on Grade 33 steel for 43 mil (18 ga) and thinner CFS members and Grade 50 steel for 54 mil (16 ga) and thicker CFS members.

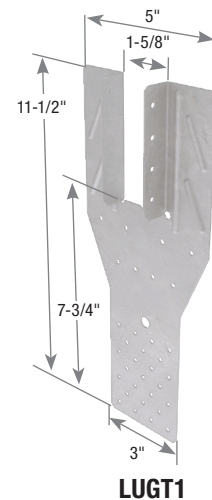

Copyright © 2022 MiTek Industries, Inc. All Rights Reserved

RT/S are designed to tie trusses and rafter to wall systems. RT/S are to resist uplift and lateral forces between framing members.

Materials: 20 gauge
Finish: G90 galvanizing

- Installation:**
- Use all specified fasteners.
 - Designer shall determine if solid blocking is required.

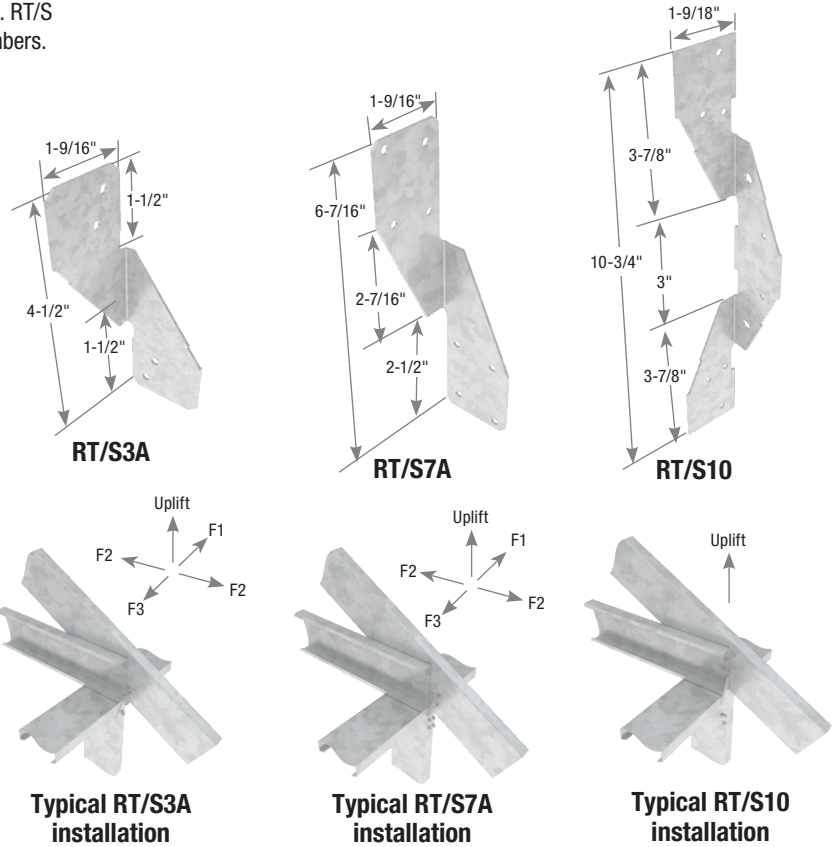

MiTek Stock No.	Ref. No.	Steel Gauge	Fastener Schedule				Allowable Loads (Lbs.) ^{1,2}				Code Ref.
			Truss/Rafter ³		Stud/Track ³		33 mil (20 ga)				
			Qty	Type ⁴	Qty	Type ⁴	Uplift	F1	F2	F3	
RT/S3A	S/H3	18	2	#10	2	#10	355	85	185	230	--
RT/S7A	S/H2.5	18	4	#10	4	#10	465	115	160	145	
RT/S10	S/H2	18	3	#10	3	#10	455	--	--	--	

1) Allowable loads are for one part only.
 2) Allowable uplift loads for the RT/S3A may be increased up to 375 lbs. when GR50 members are used.
 3) 33 mil members have been evaluated as Grade 33.
 5) #10 screws are self-drilling 0.190 inch diameter hardened washer-head screws with a minimum nominal shear strength of 1650 pounds.

MANUFACTURED HOUSING



MANUFACTURED HOUSING

342-349

Foundation Anchor	343
Hangers	344
Installation Notes	342
Nail Plates	348
Plate Tie	347
Post Anchors	348
Protection Plates	349
Rafter Ties	345-346
Stud Plate Ties	346

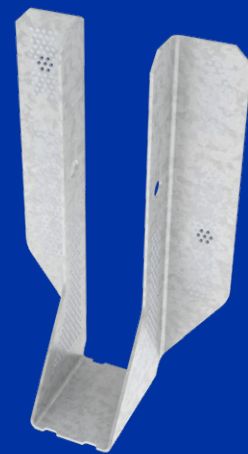

Catalog installation notes should be followed when installing pneumatic nail hangers using alternative nails. All fasteners should be installed into nailing zones and maintain minimum 1" center-to-center spacing. Alternative nail quantity required for installation of pneumatic nail hangers can be determined using the table below.

Alternative Nails for Installation of Pneumatic Hangers

Fastener Description	Dimensions (in)		DF/SP Allowable Shear per Nail (Lbs.) ^{1,2,3,4,5}			S-P-F Allowable Shear per Nail (Lbs.) ^{1,2,3,4,5}		
	Diameter	Length	Steel Gauge			Steel Gauge		
			14	18	20	14	18	20
0.099 x 1-1/2"	0.099	1-1/2	67	58	56	58	50	48
0.100 x 1-3/8"	0.100	1-3/8	68	60	57	59	51	49
0.105 x 1-1/2"	0.105	1-1/2	74	65	63	64	56	54
0.113 x 2-3/8"	0.113	2-3/8	83	75	72	72	64	62
0.131 x 1-1/2"	0.131	1-1/2	107	98	96	92	85	83
0.131 x 3"		3						
0.148 x 1-1/2"	0.148	1-1/2	127	118	116	110	102	100

- 1) Nail allowable load values were calculated as specified by the 2018 NDS; Sections 11 & 12, and Appendix I and L.
- 2) The nail lateral loads are adjusted by the Penetration depth factors, C_p , based on the length of the nails and thickness of the steel side members. However, this assumes sufficient wood thickness to receive the full length of the nail or at least ten times the diameter of the nail, whichever is less.
- 3) Adjustment factors for duration of load, service conditions and installation shall be applied to the nail values in accordance with the provisions of the NDS delineated in Sections 2, 11 and 12.
- 4) The allowable load for any connector shall not exceed the catalog value.
- 5) Fastener bending yield strength based on ASTM F1667-05 Table S1.1.
- 6) Quantity of fasteners must be used symmetrically in header flanges and into each side of joist.
- 7) Installation guidelines in MiTek's Product Catalog regarding pneumatic nail hangers must be followed.

Example:

JN28E (20 gauge) using .105 x 1-1/2" fasteners Header material: S-P-F
 JN28E downward load at 115% = 1055 lbs. Joist material: S-P-F
 JN28E uplift load at 160% = 245 lbs.

Nail Quantity Required for Downward Load:

Allowable shear capacity at 100% load duration = 54 lbs.

$$54 \left(\frac{\text{lbs}}{\text{nail}} \right) \times 1.15 = 62.1 \left(\frac{\text{lbs}}{\text{nail}} \right)$$

$$\frac{1055 \text{ lbs}}{62.1 \left(\frac{\text{lbs}}{\text{nail}} \right)} = 17 \text{ nails}$$

Use equal amount of fasteners in each side so use 9 nails in each flange for a total of 18.

Nail Quantity Required for Uplift:

$$54 \left(\frac{\text{lbs}}{\text{nail}} \right) \times 1.60 = 86.4 \left(\frac{\text{lbs}}{\text{nail}} \right)$$

$$\frac{245 \text{ lbs}}{86.4 \left(\frac{\text{lbs}}{\text{nail}} \right)} = 3 \text{ nails}$$

Use equal amount of fasteners per side of joist so use 2 in each side for a total of 4.
 Also make sure there are as many or more fasteners in the hanger to header connection.
 18 nails in header ≥ 4 nails in joist.

For installation into concrete slabs. The FA3 features a split flange for nailing to both mudsill and stud for greater framing versatility.

- Materials:** 16 gauge
- Finish:** G90 galvanizing
- Options:** See chart for Corrosion Finish Options
- Codes:** IBC, FL, LA

Installation:

- Use all specified fasteners. See Product Notes, page 18.
- Use a minimum of two anchors per mudsill. An anchor should always be within 12" of the end of each mudsill section.
- Do not rely on these anchors to secure concrete sections together between cold joints.
- Insert into wet concrete (minimum strength of 2,500 psi). Place mudsill after concrete cures. Secure flanges to sill (and stud, if applicable), bending flanges as needed to achieve a tight fit. Fasten as directed in chart.
- Do not use in red clay brick.
- For installation in severe corrosion environments, see Corrosion Information on pages 11-16.

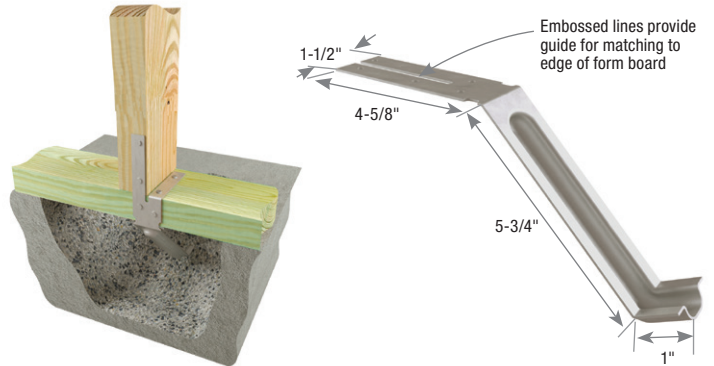

Typical FA3 one-tab-up installation



Alternate FA3 installation

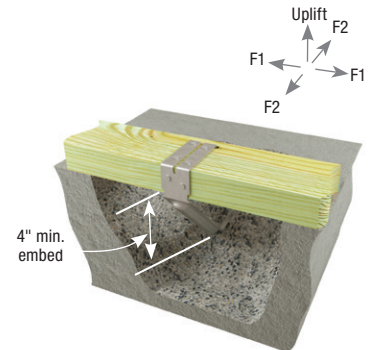

Typical FA3 standard installation in concrete

MiTek Stock No.	Ref. No.	Steel Ga.	Plate Size	Fastener Schedule ^{1,6}			Min Stemwall Thickness (in)	Installation Type	Concrete ⁵	DF/SP Allowable Loads (Lbs.) ^{2,3,4}			Corrosion Finish	Code Ref.	
				Sill Plate		Stud				Type	Uplift 160%	F1 160%			F2 160%
				Side Qty	Top Qty	Qty									
Wind and ASCE Seismic Design A & B															
FA3	--	16	Single 2x	2	4	--	10d x 1-1/2	6	Standard	Uncracked	1350	750	1015	IBC, FL, LA	
				2	2	2				Cracked	945	525	710		
			Single 3x	2	4	--	10d x 1-1/2	6	Standard	Uncracked	--	515	--		--
				2	4	--				Cracked	--	475	--		
ASCE Seismic Design C-F															
FA3	--	16	Single 2x	2	4	--	10d x 1-1/2	6	Standard	Uncracked	1120	550	890	IBC, FL, LA	
				2	2	2				Cracked	830	460	625		
			Single 3x	2	4	--	10d x 1-1/2	6	Standard	Uncracked	--	515	--		--
				2	4	--				Cracked	--	405	--		

- 1) Predrilled holes are not required.
- 2) Allowable Stress Design (ASD) values have been adjusted for a load duration factor, CD, of 1.6 corresponding to a ten-minute load duration (i.e. wind or earthquake loading) in accordance with the NDS. The ASD loads do not apply to loads of other durations.
- 3) Allowable loads are based on a minimum stemwall thickness of 6", minimum distance from the end of the concrete wall of 4" and minimum anchor spacing of 8".
- 4) Uplift deformation based on wood connection strength.
- 5) Minimum concrete strength f'c = 2,500 psi.
- 6) **NAILS:** 10d x 1-1/2 nails are 0.148" dia. x 1-1/2" long.

Corrosion Finish Key ■ Stainless Steel ■ Gold Coat ■ HDG ■ Triple Zinc

MiTek's "no hole" connectors are engineered for wood frame structures built in a factory environment. These connectors feature embossed "nailing zones" for faster and safer fastener installation.

Materials: 18 or 20 gauge
Finish: G90 galvanizing
Codes: See chart for references

Installation:

- Install all specified fasteners using a pneumatic nailer.
- Nailing zones are distinguished by embossed pattern.
- Install fasteners with care not to overdrive fastener causing indentation of connector.
- Fastener quantities shall be installed symmetrically on both sides of connector.
- Installer should reduce risk of injury from rebounding fasteners by using personal eye protection during fastener installation.
- Minimum center-to-center fastener spacing is 1".



Typical MTHF installed with Engineered I-Joist



Typical MTHF installed with Floor Truss



Typical JNE installed with Solid Sawn Lumber



MTHF25925
(MTHF25112 similar)

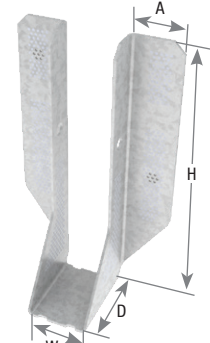

JN28E

Joist Size	MiTek Stock No.	Ref. No.	Steel Gauge	Dimensions (in)				Fastener Schedule ^{1,2,3}			DF/SP Allowable Loads (Lbs.)				S-P-F Allowable Loads (Lbs.)				Code Ref.
				W	H	D	A	Header Qty	Joist Qty	Type	Allowable Loads (Lbs.)				Allowable Loads (Lbs.)				
											Floor	Roof	Uplift ⁴	Floor	Roof	Uplift ⁴			
2 x 6-8	JN26E	MMLU26	20	1-9/16	4-13/16	2	1-1/4	10	4	"P" nails	600	690	750	305	530	610	640	245	IBC, FL, LA
								16	4	"P" nails	960	1105	1200	305	845	975	1000	245	
								20	4	"P" nails	1200	1325	1325	305	1055	1055	1055	245	
2 x 8-10	JN28E	MMLU28	20	1-9/16	6-11/16	2	1-3/16	10	4	"P" nails	600	690	750	305	530	610	640	245	
								16	4	"P" nails	960	1105	1200	305	845	975	1000	245	
								20	4	"P" nails	1200	1325	1325	305	1055	1055	1055	245	
2 x 10-12	JN210E	MMLU210	20	1-9/16	7-15/16	2	1-5/16	10	4	"P" nails	600	690	750	305	530	610	640	245	
								16	4	"P" nails	960	1105	1200	305	845	975	1000	245	
								20	4	"P" nails	1200	1325	1325	305	1055	1055	1055	245	
(2) 2 x 6-8	JN26-2	MMLU26-2	18	3-1/8	5-3/8	2-1/8	1-1/4	10	6	"P" nails	610	700	765	585	540	610	610	515	
								16	6	"P" nails	975	1120	1220	585	860	990	1075	515	
								24	6	"P" nails	1465	1685	1830	585	1290	1485	1615	515	
(2) 2 x 8-10	JN28-2	MMLU28-2	18	3-1/8	7-1/8	2-1/8	1-1/4	10	6	"P" nails	610	700	765	585	540	610	610	515	
								16	6	"P" nails	975	1120	1220	585	860	990	1075	515	
								24	6	"P" nails	1465	1685	1830	585	1290	1485	1615	515	
2-1/2 x 9-1/4 - 9-1/2	MTHF25925	MMLUI39	20	2-9/16	9-1/8	2	1-1/4	10	4	"P" nails	600	690	750	305	530	610	635	245	
								16	4	"P" nails	960	1105	1200	305	845	975	995	245	
2-1/2 x 11-7/8	MTHF25112	MMLUI311	20	2-9/16	11-1/8	2	1-1/4	10	4	"P" nails	600	690	750	305	530	610	635	245	
								16	4	"P" nails	960	1105	1200	305	845	975	995	245	

1) "P" nails denotes fasteners designed specifically to be installed with a pneumatic-powered nailer. The fasteners shall be either of a type with round heads, 0.105" diameter and 1-3/8" long; or a "T" shaped head, 0.097" diameter, 1-1/4" long and hardened; or a similar but larger fastener.
 2) Fasteners shall be pneumatically driven in such a way as firmly seats the nail head against the hanger steel, without embedding the nail head completely through the plane of the metal surface, or otherwise punching through.
 3) The quantity of nails installed shall be equally distributed to both sides of the hanger. The nails shall be located at 1" spacing in a row, with the vertical rows spaced at 3/8"; also no less than 5/16" from a sheared edge and no less than 5/16" from a formed edge.
 4) Uplift loads have been increased 60% for wind or seismic load conditions; no further increase shall be permitted.

The RST3 rafter tie is designed to anchor trusses and rafters directly to the stud below. The ability to field-bend the RST3 permits fastening to either the wide or narrow face of the stud.

Materials: 18 gauge
Finish: G90 galvanizing

Installation:

- Use all specified fasteners.
- If necessary, field bend the lower tab of the RST3 at 90° at the two bend slots.
- Not all fastener holes need to be filled.
- Fasteners in truss do not need to penetrate a nailing plate to achieve the uplift loads listed below.
- The RST3 can be installed in pairs (on opposite sides of the wall, to achieve twice the uplift capacity).



RST3



Figure 1



Figure 2



Figure 3



Figure 4



Figure 5



Figure 6

MiTek Stock No.	Ref. No.	Steel Gauge	Dimensions (in)		Installation Type	Qty of RST3's	Fastener Schedule				DF/SP Allowable Loads (Lbs.) ¹	S-P-F Allowable Loads (Lbs.) ¹	Code Ref.
			W	L			Rafter/Truss		Stud				
							Qty ³	Type ²	Qty ³	Type ²	Uplift 160%	Uplift 160%	
RST3	RST-3	18	1-1/2	10-5/16	Figure 1	1	4	#8 x 1-1/2	4	#8 x 1-1/2	555	465	--
					Figure 2	1	4	#8 x 1-1/2	4	#8 x 1-1/2	555	465	
					Figure 3	2	8	#8 x 1-1/2	8	#8 x 1-1/2	1110	930	
					Figure 4	2	8	#8 x 1-1/2	8	#8 x 1-1/2	1110	930	
					Figure 5	2	8	#8 x 1-1/2	8	#8 x 1-1/2	1110	930	
					Figure 6	2	8	#8 x 1-1/2	8	#8 x 1-1/2	1110	930	

1) Allowable loads have been increased 60% for wind or seismic loads; no further increase shall be permitted.

2) #8 x 1-1/2 wood screw has a diameter of 0.164" and a length of 1-1/2".

3) Fastener quantities shown are the total number installed in (1) or (2) RST3 connectors.

MRT7 Rafter Tie

Manufactured Housing Connectors

MH Connectors

The MRT7 Rafter Tie is engineered for wood frame structures built in a factory environment. These connectors feature embossed "nailing zones" for faster and safer fastener installation.

Materials: 14 gauge
Finish: G90 galvanizing

Installation:

- Install all specified fasteners using a pneumatic nailer.
- Nailing zones are distinguished by embossed pattern.
- Install fasteners with care not to overdrive fastener causing indentation of connector.
- Fastener quantities shall be installed symmetrically on both sides of connector.
- Installer should reduce risk of injury from rebounding fasteners by using personal eye protection during fastener installation.
- Minimum center-to-center fastener spacing is 1".



Typical MRT7 installation



Typical Knee Wall Set with MRT7 installation



MiTek Stock No.	Ref. No.	Steel Gauge	Dimensions (in)		Fastener Schedule ^{1,2,3}			DF/SP Allowable Loads (Lbs.)			S-P-F Allowable Loads (Lbs.)			Code Ref.
			W	L	Header Qty	Joist Qty	Type	Uplift ⁴ 160%	F1 160%	F2 160%	Uplift ⁴ 160%	F1 160%	F2 160%	
MRT7	MMH8	18	1-1/4	7-13/16	3	3	P or "T" nails	295	135	135	255	85	85	--
					4	4	P or "T" nails	390	180	180	340	115	115	
					5	5	P or "T" nails	490	195	195	425	145	145	
					6	6	P or "T" nails	585	195	195	510	175	175	

- 1) "P" nails denotes fasteners designed specifically to be installed with a pneumatic-powered nailer. The fasteners shall be either of a type with round heads, 0.105" diameter and 1-3/8" long; or a "T" shaped head, 0.097" diameter, 1-1/4" long and hardened; or a similar but larger fastener.
- 2) Fasteners shall be pneumatically driven in such a way as firmly seats the nail head against the hanger steel, without embedding the nail head completely through the plane of the metal surface, or otherwise punching through.
- 3) The quantity of nails installed shall be equally distributed to both sides of the hanger. The nails shall be located at 1" spacing in a row, with the vertical rows spaced at 3/8"; also no less than 5/16" from a sheared edge and no less than 5/16" from a formed edge.
- 4) Uplift loads have been increased 60% for wind or seismic load conditions; no further increase shall be permitted.

SPTHW Stud Plate Ties

MiTek's SPTHW is a Stud Plate Tie that can be installed on the top and bottom of each stud at the component plant to stiffen for shipping and handling. Designed to be installed over 1/2" structural sheathing.

Materials: 18 gauge
Finish: G90 galvanizing
Codes: IBC, FL, LA

Installation:

- Install all specified fasteners.

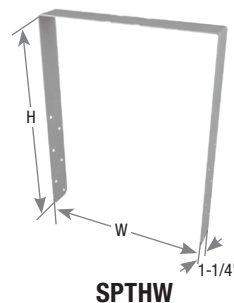

SPTHW

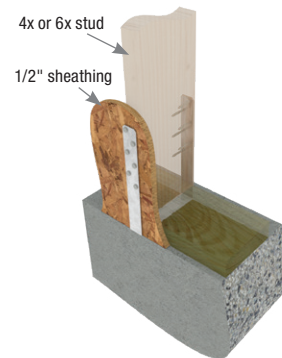

Typical SPTHW installation

Stud Size	MiTek Stock No.	Ref. No.	Steel Gauge	Dimensions (in)		Fastener Schedule ²		DF/SP Allowable Loads (Lbs.)	Code Ref.
				W	H	Qty	Type	Uplift 160% ¹	
4x	SPTHW4	SPH4R	18	4-1/16	8-3/8	12	10d x 1-1/2	2195	IBC, FL, LA
6x	SPTHW6	SPH6R	18	6-1/16	9-1/8	12	10d x 1-1/2	2195	

- 1) Uplift loads have been increased 60% for wind or seismic loads; no further increase shall be permitted.
- 2) **NAILS:** 10d x 1-1/2 nails are 0.148" dia. x 1-1/2" long.

MPF Multi-Lateral Plate Tie

Manufactured Housing Connectors

MH Connectors

Connects 2x framing with floor sheathing up to 5/8".

- Materials:** 20 gauge
- Finish:** G90 galvanizing
- Options:** See chart for Corrosion Finish Options
- Codes:** IBC, FL, LA
- Installation:**
 - Use all specified fasteners.

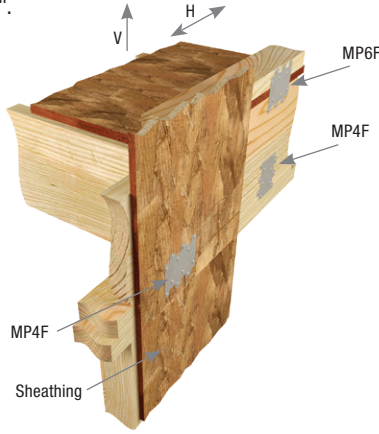

Typical MPF installation

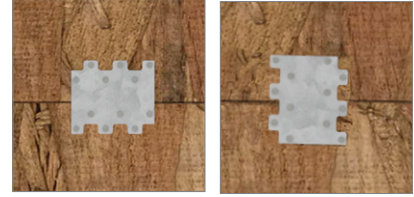

Type 1

Type 2

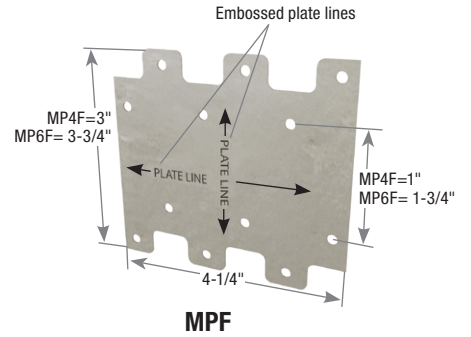

MPF

MiTek Stock No.	Ref. No.	Steel Gauge	Installation Type ^{2,4}	Fastener Schedule ^{4,6}				Direction of Load ²	DF/SP Allowable Loads (Lbs.) ^{1,3}				S-P-F Allowable Loads (Lbs.) ^{1,3}				Corrosion Finish	Code Ref.
				Header or Stud		Joist or Plate			100%	115%	125%	160%	100%	115%	125%	160%		
				Qty	Type	Qty	Type											
MP4F	LTP4	20	Type 1	6	8d x 1-1/2	6	8d x 1-1/2	V	590	670	720	750	505	575	615	645		IBC, FL, LA
								H	590	670	720	750	505	575	615	645		
			Type 2	6	8d x 1-1/2	6	8d x 1-1/2	V	590	670	720	750	505	575	615	645		
								H	585	585	585	585	500	500	500	500		

- 1) Allowable loads have been increased 60% for wind or seismic loads; no further increase shall be permitted.
 - 2) Refer to drawings for installation type and definition of the various load directions.
 - 3) If installing over plywood, use 8d common nails for 100% of table load.
 - 4) 8d common (0.131" dia. x 2-1/2" long) nails may be substituted for 8d x 1-1/2" nails with no allowable load reduction.
 - 5) **NAILS:** 8d x 1-1/2 nails are 0.131" dia. x 1-1/2" long.
- New products or updated product information are designated in **blue font**.

Corrosion Finish Key ■ Stainless Steel ■ Gold Coat ■ HDG ■ Triple Zinc

Copyright © 2022 MiTek Industries, Inc. All Rights Reserved

D Post Anchors

Manufactured Housing Connectors

Porch design for any structure must account for the wind exposure. Porches present lots of sail area to catch the wind and can develop very high wind uplift in ordinary wind events. They must be securely tied to the foundation. MiTek engineers and manufactures products intended to provide a load path from the porch components to the foundation.

Materials: 18 gauge
Finish: G-185 galvanizing
Options: See chart for Corrosion Finish Options
Codes: IBC, FL, LA

Installation:

- Use all specified fasteners.
- **Not recommended for fence posts or other unrestrained (not fixed or fastened at top) applications. These anchors are not designed to resist overturning (moment) loads.**
- D44-TZ offers lateral and uplift resistance: they are not recommended as a primary means of anchorage for posts in railings.



Typical D44-TZ installation

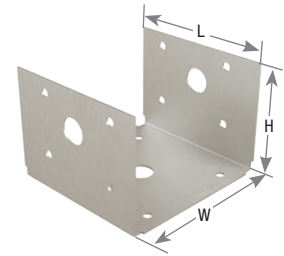

D44-TZ

Post Size	MiTek Stock No.	Ref. No.	Steel Gauge	Dimensions (in)			Fastener Schedule ²				DF/SP Allowable Loads (Lbs.) ¹			S-P-F Allowable Loads (Lbs.) ¹			Corrosion Finish	Code Ref.
				W	H	L	Post		Beam		Uplift 160%	F1 160%	F2 160%	Uplift 160%	F1 160%	F2 160%		
							Qty	Type	Qty	Type								
4 x 4	D44-TZ	BC40, BC40Z	18	3-9/16	2-1/2	3-3/8	8	16d HDG	4	16d HDG	700	885	885	565	760	760	Gold Coat	IBC, FL, LA

¹ Allowable loads have been increased 60% for wind or seismic loads; no further increase shall be permitted.
² **NAILS:** 16d nails are 0.162" dia. x 3-1/2" long.

Corrosion Finish Key
■ Stainless Steel ■ Gold Coat
■ HDG ■ Triple Zinc

NP Nail Plates

The NP Nail Plates are an ideal economical solution for attaching wooden members together in a non-structural connection. Also may be used as a prescriptive top plate splice per the International Residential Code (IRC). They are pre-punched for 8d common nails.

Materials: 20 gauge
Finish: G90 galvanizing
Codes: IRC R602.3.2

Installation:

- Use nails appropriate for intended use. Holes are sized for 8d common (0.131" dia. x 2-1/2" long) or 8d (0.131" dia.) x 1-1/2" nails.
- The designer shall determine appropriate load values.



NP

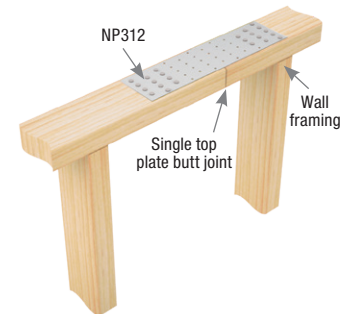

Typical NP312 prescriptive top plate splice installation

MiTek Stock No.	Ref. No.	Steel Gauge	Dimensions (in)		Number of Nail Holes	Code Ref.
			W	L		
NP15	TP15	20	1-13/16	5	12	--
NP35	TP35	20	3-1/8	5	22	
NP37	TP37	20	3-1/8	7	31	
NP39	TP39	20	3-1/8	9	40	
NP311	TP311	20	3-1/8	11	49	
NP312	TP312	20	3-1/8	12	54	
NP315	TP316	20	3-1/8	15	67	
NP45	TP45	20	4-1/8	5	30	
NP47	TP47	20	4-1/8	7	42	
NP49	TP49	20	4-1/8	9	54	
NP411	TP411	20	4-1/8	11	66	
NP57	TP57	20	5-3/4	7	59	

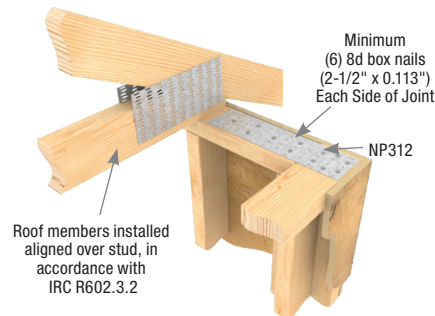

Typical NP312 prescriptive top-plate wall corner connection

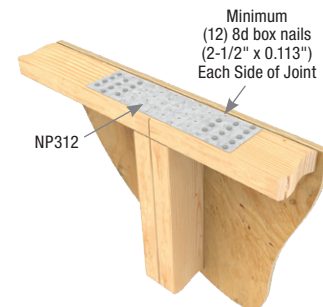

Typical NP312 prescriptive top-plate butt joint straight wall connection

Plumbing / Electrical Protection Plates

Manufactured Housing Connectors

MH Connectors

Easy-to-install plates protect plumbing and power/communication wiring from nail or screw penetration.

ICPL58 – Installs with nails

KNS1 / PL4 – Prongs allow for quick installation

Materials: 16 gauge

Finish: ICPL516-TZ – G-185 galvanizing; All other – G90 galvanizing.

Options: See chart for Corrosion Finish Options

Installation:

- Use all specified fasteners.
- 16 gauge steel conforms to protection shield plate requirements of the National Electrical Code and International Plumbing Code.

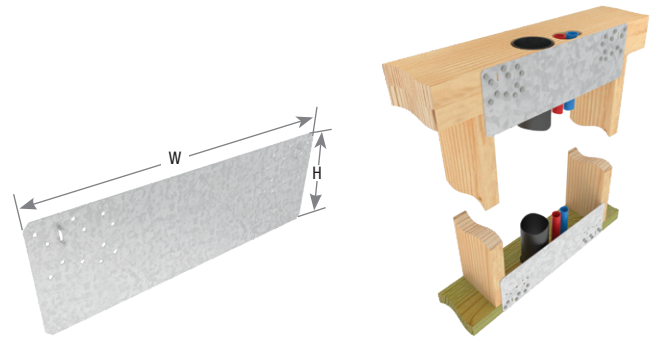

ICPL516-TZ

Typical ICPL516-TZ installation

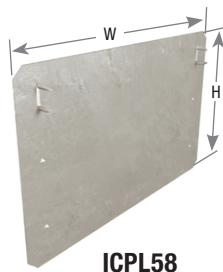

ICPL58



Typical ICPL58 installation



KNS1

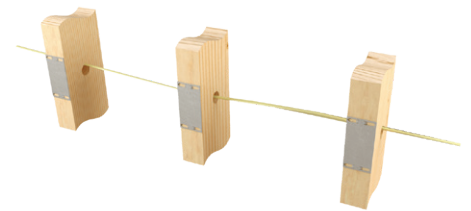

Typical KNS1 / PL4 installation



PL4



Typical PL4 installation

MiTek Stock No.	Ref. No.	Steel Gauge	Dimensions (in)		Installation Type	Fastener Schedule ²		DF/SP Allowable Loads (Lbs.) ¹	S-P-F Allowable Loads (Lbs.) ¹	Corrosion Finish	Code Ref.
			W	H		Qty	Type				
ICPL58	--	16	8-1/16	5	--	4	8d or prongs	--	--	Green	PC
PL4	NS2	16	2	5	--	--	prongs	--	--	Green	
KNS1	NS1	16	1-1/2	3	--	--	prongs	--	--	Green	
ICPL516-TZ	PSPN516Z	16	16-1/4	5	Sill Plate	12	16d HDG + prongs	1355	1160	Green	
					Double Top Plate	16	16d HDG + prongs	1805	1550	Green	

1) Allowable loads have been increased 60% for wind or seismic loads; no further increase shall be permitted.

2) **NAILS:** 8d nails are 0.131" dia. x 2-1/2" long, 16d nails are 0.162" dia. x 3-1/2" long.

Corrosion Finish Key ■ Stainless Steel ■ Gold Coat ■ HDG ■ Triple Zinc

Copyright © 2022 MiTek Industries, Inc. All Rights Reserved

LATERAL SYSTEMS



LATERAL SYSTEMS

352-354

Hardy Frame® CFS Moment Frames	353
Hardy Frame® Moment Frames	353
Hardy Frame® Shear Walls	352
Z4 Tie-Down Systems	354



Hardy Frame® Code Evaluation

Hardy Frames has been leading the pre-manufactured shear wall industry from its beginning. Hardy Frames were the first to be recognized by ICBO-ES and LA City, first to gain approval for multi-story applications, first Balloon Wall application and first to be recognized to comply with the 2003 and 2006 IBC and IRC Building Codes. Today we are the first and only to offer a 9" Panel width and a Balloon Wall application that is fully assembled in the manufacturing plant and ships as a one piece unit.

All Hardy Frame® Shear Walls are code listed under the 2018 IBC and IRC codes and include installations on concrete, raised floor and upper floor systems.

Hardy Frame® Panels

ICC-Evaluation Service ESR-2089

- Panels are available in 9, 12, 15, 18, 21 and 24" widths
- Standard Heights range from 78" for portal applications to 20' for Balloon Walls
- Custom heights are manufactured routinely
- R Value for design = 6.5, Cd = 4.0
- "Back to Back" installations provide two times the allowable shear value without increasing the wall length

Hardy Frame® Brace

ICC-Evaluation Service ESR-2089

- Available in 32 and 44" widths
- Standard Heights range from nominal 8 to 13 feet
- Custom heights are manufactured routinely
- R Value for design = 6.5, Cd = 4.0
- For a given shear load, installing a wider shear wall results in reduced overturning

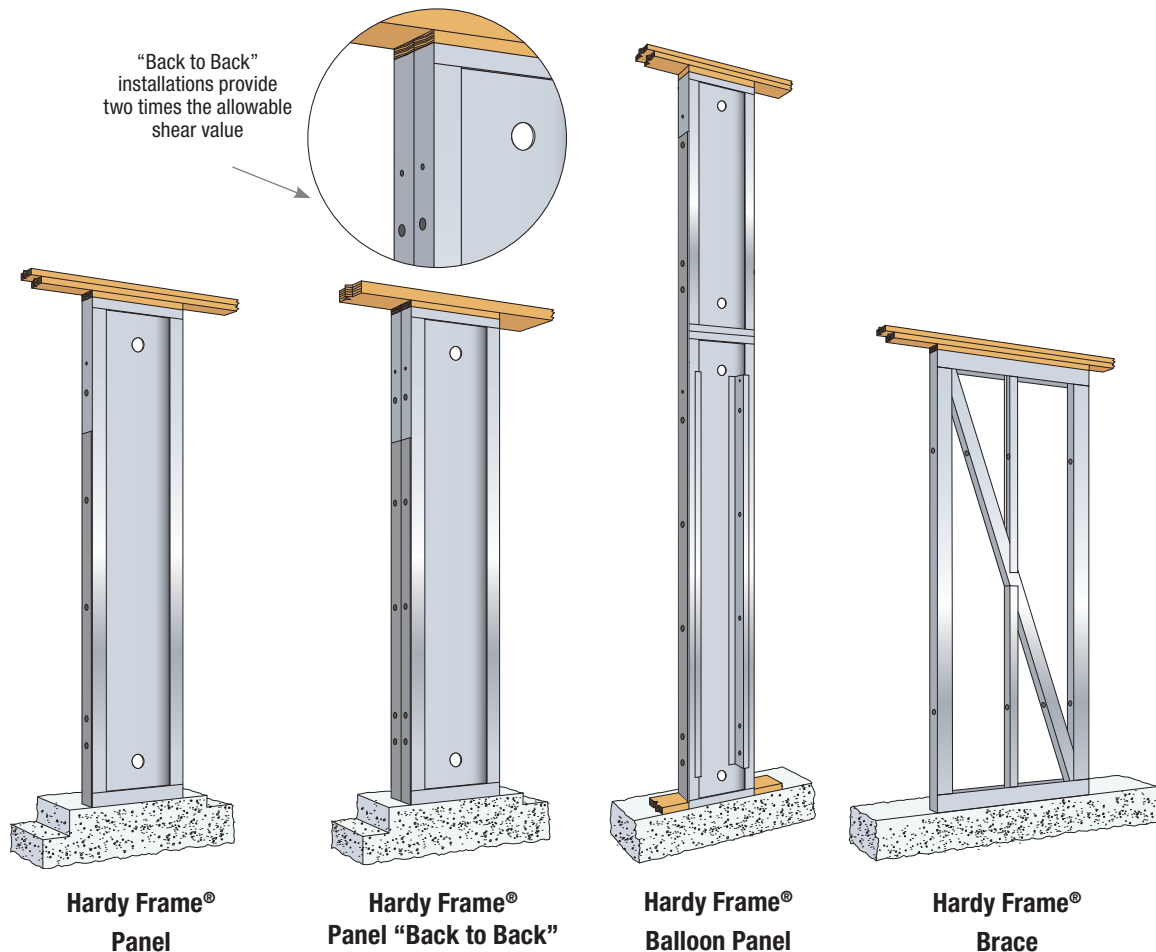

Copyright © 2022 MiTek Industries, Inc. All Rights Reserved

The First and Only Cold Formed Steel (CFS) Moment Frames

The all new MiTek Hardy Frame® CFS Moment Frame and CFS Picture Frame are the industries first standardized, pre-engineered, pre-manufactured cold formed steel moment frames.

Lighter and less cost than structural steel moment frames, our CFS product line provides high capacities, ductility and cost economics that complete a spectrum of MiTek shear wall solutions.

Standard configurations are the Hardy Frame® CFS Moment Frame (portal applications) and the Hardy Frame CFS Picture Frame for stacking in multi-story applications.

Hardy Frame® CFS Moment Frame

Code Report: ER-491

- Similar materials and installation as Hardy Frame Panels the industry leader for 20 years
- Available in standard designs and standard detailing
- Capacities that are equal to four or five Hardy Frame Panels of same width
- Can be installed “Back to Back” to double the capacity

Hardy Frame® CFS Picture Frame

- Sill beam that assembles at the bottom of the Frame distributes compression over wood below to significantly reduce crushing and maintain shear capacity
- Incorporates the MiTek Z4 Continuous Tie-Down System to transfer overturning and uplift forces to the foundation
- Narrow columns (12 through 21") and shallow beam depths (12 and 15") enable large openings and architectural freedom
- Ships as a “knock-down” unit: easy to handle, ship and field assemble



Hardy Frame® Moment Frames

MiTek Hardy Frame® Special Moment Frames are constructed of wide flange columns connected to hollow structural steel (HSS) beams with SidePlate special moment connections.

The SidePlate special moment connection is approved in the AISC 358 Prequalified Moment Connections Standard and the review included testing that confirmed lateral bracing to prevent twist and out-of-plane displacements is not required at the hollow structural section (HSS) beams. Standard configurations are the Hardy Frame® Moment Frame with a pinned base and the Hardy Frame® Picture Frame.

Hardy Frame® Moment Frame

- Standard designs for nominal 6" through 14" column depths with pinned base anchorage are now available
- Delivery options for pre-assembled, bolted column splice or “knock-down”
- All standard designs fit in typical 8" wall framing, 6" column depths fit 6" framing
- New construction and retrofit applications
- Includes wood nailers at top & bottom of HSS beam and at all column flanges



Hardy Frame® Picture Frame

- Constructed with HSS beams at top and bottom of Frame, SidePlate special moment connections at all four corners
- HSS beam at bottom of Frame eliminates the engineering and field construction of costly grade beams
- Significant reductions in installation time result from elimination of field built grade beam
- Standard designs for nominal 6" through 14" column depths that fit into typical wall framing with double the capacity of our pinned base option are now available
- All the same delivery options and wood nailer inclusions as the Hardy Frame® Moment Frame with pinned base



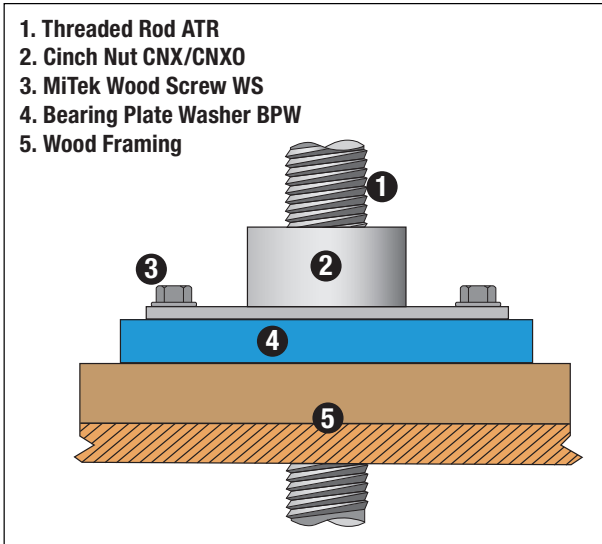

MiTek® Z4 Tie-Down Systems utilize CNX-Series Cinch Nuts to compensate for wood shrinkage and building settlement that cause connections to loosen over time. The Cinch Nut uses a self-ratcheting action that permits the cinch nut to move (the rod doesn't move) or "travel" perpetually in one direction only down the rod. Available for installation with threaded rods that are 3/8" through 1-1/2" diameter in 1/8" increments, the CNX/CNX0 Cinch Nut has been code evaluated and published in ESR-2190.

- Place the specified Bearing Plate Washer onto the bottom plate of a wood framed wall.
- With the "wings" oriented downward, place Cinch Nut over the ATR extending from below and push down until it seats firmly on the Bearing Plate Washer.
- Install 1/4" diameter MiTek® WS Screws through the wings, penetrating 1" (minimum) into the wood bottom plate.
- Model numbers BPW5 and BPW6 fit in-between the screws fastening the wings.
- Model numbers BPW7 (3-1/4" x 4-3/8") and larger are provided with two screw holes. Align the wing and the Bearing Plate Washer screw holes to allow installation of 1/4" diameter MiTek® WS Screws.

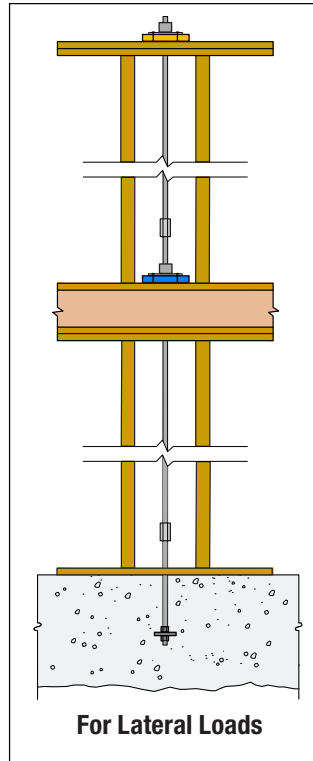
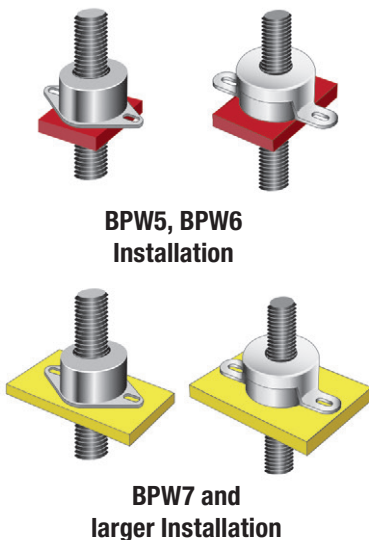

MiTek® Z4 Tie-Down System for Lateral Load

To resist tension loads due to overturning moments in multi-story buildings the Cinch Nut is installed over a Bearing Plate Washer at each level in a fast and easy application. At the upper-most level a Cinch Nut is installed over a Bearing Plate Washer above the top plates. At walls below that bear on wood floor systems, the Cinch Nut and Bearing Plate Washer are installed over the bottom plate. Tension loads are gathered at each level and transferred into the foundation through a continuous system of Cinch Nuts, Bearing Plate Washers, ATRs and Couplers all are available lines of MiTek.

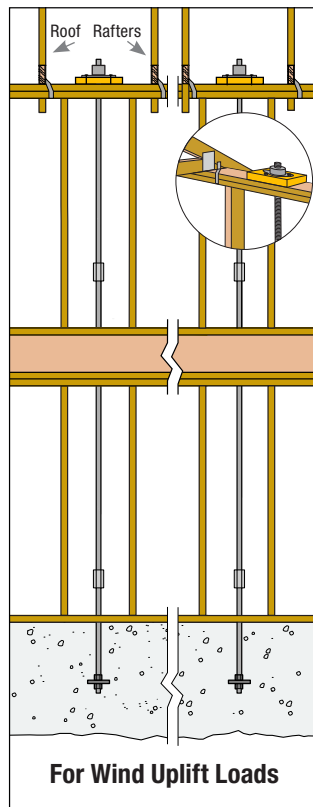

MiTek® Z4 Tie-Down System for Wind Uplift

For resisting roof uplift loads resulting from wind the Z4 Cinch Nut is installed over a Bearing Plate Washer above the top plates with roof framing above to create a tie-down system. Uplift forces are transferred into a continuous system of ATRs and Couplers that form a load path to the foundation.

INTEGRATED BUILDING SOLUTIONS



SERVICES

Scale your business and outputs (take-offs, estimating, job quotes, and more) with the comfort of fixed overhead costs.



AUTOMATED SOLUTIONS

Optimize your entire prefabrication facilities workflow with off-site solutions that enable better on-site building.



SOFTWARE

Enhance your operational performance with software solutions that connect the entire supply chain.



ENGINEERED SYSTEMS & PRODUCTS

Accelerate your building process with a full range of advanced solutions that save on labor and installation costs.



MADE IN AMERICA. DESIGNED TO LAST.

Our structural connector products are designed to last and manufactured and distributed in 9 strategic locations in the United States.

WAREHOUSE & DISTRIBUTION

CALIFORNIA

120 Klug Circle
Corona, California 92880
Will Call Hours: 8:00 am to 4:30 pm PST

CALIFORNIA

25315 S. Schulte Road
Tracy, California 95377
Will Call Hours: 8:00 am to 4:00 pm PST

GEORGIA

4380 International Parkway,
Suite A
Atlanta, Georgia 30354
Will Call Hours: 7:30 am to 4:00 pm EST

NEW JERSEY

120 Hancock Lane
Westampton, New Jersey 08060
Will Call Hours: Mon-Thur 8:00 am to 5:00 pm,
Friday only - 8:00 am to 4:00 pm EST

TEXAS

14418-A Smith Road
Humble, Texas 77396
Will Call Hours: 7:30 am to 4:00 pm CST

MANUFACTURING

ARIZONA

7890 W. Lincoln Street
Phoenix, Arizona 85353
Will Call Hours: 8:00 am to 4:30 pm MST

FLORIDA

11910 62nd Street North
Largo, Florida 33773
Will Call Hours: 8:30 am to 4:30 pm EST

MINNESOTA

703 Rogers Drive
Montgomery, Minnesota 56069
Will Call Hours: 8:00 am to 4:30 pm CST

Access our catalog online for the latest information at
mitek-us.com/resources/product-catalog

P: 1-800-328-5934 | F: 952-898-8605
customerservice@mii.com

MITEK-US.COM